

RICHIEDENTE

APPLICANT / CLIENT / ANTRAGSTELLER

.....



TIMBRO / CUSTOMER'S SEAL / TAMPON / STEMPEL

MODELLO

MODEL / MODELE / MODELL **ELIO : EL-FA**

ALTEZZA

HEIGHT / HAUTEUR / HÖHE **2000** mm.



REVERSIBILE

REVERSIBLE / RÉVERSIBLE / UMKEHRBAR

LASTRA

GLASS / VERRE / GLAS

COLORE

COLOUR / COULEUR / FARBE

INSTALLAZIONE

INSTALLATION / TYPE D'INSTALLATION
 INSTALLATION

A PAVIMENTO

FLOOR INSTALLATION
 SUR LE SOL
 BODENMONTIERT

SU PIATTO DOCCIA

SHOWER TRAY INSTALLATION
 SUR RECEVEUR
 AUF DUSCHWANNE

NOTE / NOTES / NOTES

.....

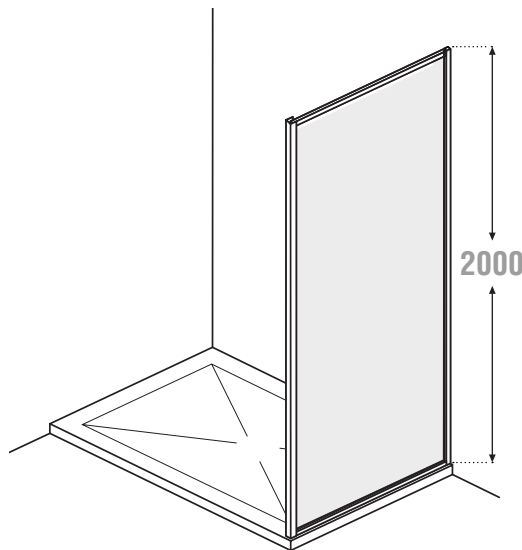
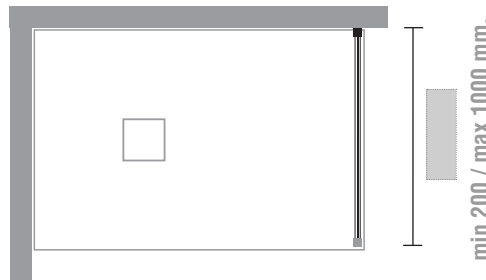

INSTALLAZIONE SU PIATTO DOCCIA, A PAVIMENTO O SU PIATTO DOCCIA INCASSATO A FILO PAVIMENTO
INSTALLATION ON SHOWER TRAY, ON FLOOR OR ON BUILT-IN SHOWER TRAY FLUSH TO THE FLOOR
INSTALLATION SUR RECEVEUR DE DOUCHE, AU SOL OU SUR RECEVEUR DE DOUCHE ENCASTRÉ AU SOL
INSTALLATION AUF DEM BODEN ODER AUF EINER BODENBÜNDIGEN DUSCHWANNE

INSTALLAZIONE STANDARD / STANDARD / INSTALLATION / INSTALLATION STANDARD / STANDARDINSTALLATION

La parete doccia è installata all'interno dello spazio, sia su piatto doccia che a pavimento.

The enclosure is installed within the shower space, either on a shower tray or directly on the tiled floor.

La paroi de douche est à installer à l'intérieur de l'espace douche, sur un receveur ou directement sur le sol carrelé.

Die Duschwand wird innerhalb des Duschbereichs, auf Duschwanne oder direkt auf den Fliesen installiert.

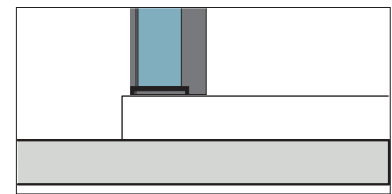
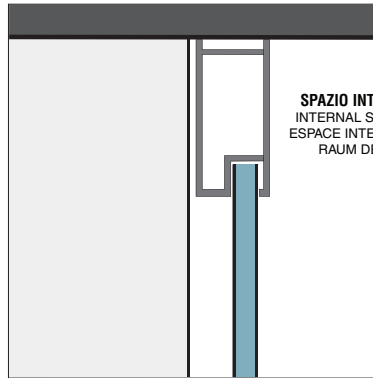
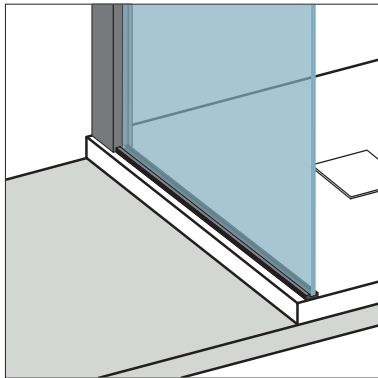

INSTALLAZIONE ESTERNA / EXTERNAL INSTALLATION / INSTALLATION EXTÉRIEUR / INSTALLATION AUßERHALB DES DUSCHBEREICHS

La parete doccia è installata completamente all'esterno dello spazio doccia.

The shower enclosure is installed completely outside the shower space.

La paroi de douche est installée complètement à l'extérieur de l'espace de douche.

Die Duschwand wird außerhalb des Duschrums installiert.

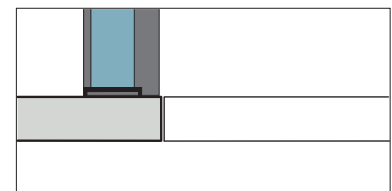
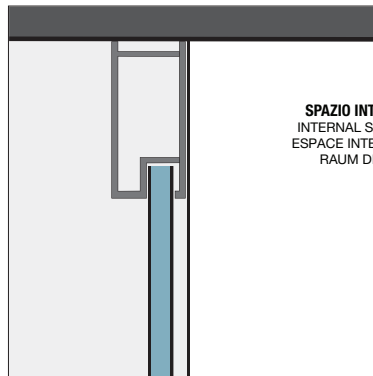
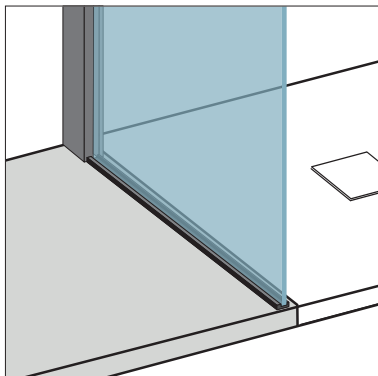

FUGA A MEZZERIA DEL VETRO / GLASS ON THE GROUT LINE / VERRE AU DESSUS DU JOINT / GLAS AN DER FUSSLINIE

La parete doccia è installata con il vetro sulla mezzeria della fuga tra spazio doccia e pavimento.

The glass of the enclosure is installed exactly on a grout line dividing the shower space from the floor area.

Le verre de la paroi est installé exactement sur le joint qui sépare l'espace de douche du sol.

Die Duschwand wird exakt auf der Fliesenfuge installiert

