

Listino prezzi .026

Price list .026



# ITALIAN BATHROOM ART

PARETI DOCCIA

TDA

ITALIAN BATHROOM ART

# PARETI DOCCIA

## SHOWER ENCLOSURES

INFORMAZIONI GENERALI pag 6  
GENERAL INFORMATION

### walk-in

ITALO pag 40  
VITO pag 74  
ROCCO pag 84

### con profilo verticale / with vertical profile

ENZO pag 94  
FRIGO pag 104  
INOX SCROLL pag 116  
INOX RAIL pag 124  
PLUMA EVO pag 134  
GAIA pag 150  
MORK pag 166  
MINDY pag 186  
VOLO pag 206  
FONT pag 222

### con telaio / with frame

ELIO pag 232  
OTTAVIO pag 258  
DADO MAXI pag 280  
DINO pag 308  
SPADO pag 332  
COMFORT pag 350

SOPRAVASCA pag 386  
BATHTUB

RICAMBI E PROFILI SPECIALI pag 406  
SPARE PARTS and SPECIAL PROFILES

SCHEDE RILIEVO MISURE pag 444  
MEASUREMENTS FORMS

INFORMAZIONI E SERVIZI pag 450  
INFO AND SERVICES

## TDA | ITALIAN BATHROOM ART

Radicata nel cuore industriale della provincia di Brescia, **TDA** nasce dall'incontro tra tradizione e innovazione. Guidata da Luca e Marco Domeneghini, l'azienda è sinonimo di coerenza, passione e determinazione, valori che si riflettono in ogni prodotto realizzato.

Siamo tra le poche realtà italiane a produrre integralmente sul territorio pareti doccia, piatti doccia e mobili da bagno, seguendo un processo interno che unisce rigore artigianale, cura dei dettagli e controlli costanti di qualità e sicurezza. Ogni manufatto TDA è frutto di materiali selezionati, competenze aggiornate e un design italiano distintivo, pensato per durare nel tempo e rispettare l'ambiente.

Il nostro marchio dedicato all'arredo bagno nasce nel 1982 con il nome **CIMA ARREDOBAGNO**. Fin dall'inizio ci siamo dedicati a tutto ciò che poteva arricchire l'ambiente bagno con colore, materia e innovazione, prima con gli arredi, poi con le pareti doccia, fino al 2012, anno in cui abbiamo introdotto il nostro esclusivo materiale composito **AROCK®**, che ci ha permesso di realizzare i primi piatti doccia e successivamente piani e lavabi dal design unico.

Made in Italy per noi non è solo un'etichetta, ma una filosofia: ogni prodotto è realizzato a mano, con orgoglio, nei nostri stabilimenti a pochi chilometri l'uno dall'altro, portando avanti la cultura bresciana e l'eccellenza italiana nell'arredo bagno.

Rooted in the industrial heart of the province of Brescia, **TDA** was born from the meeting of tradition and innovation. Led by Luca and Marco Domeneghini, the company stands for consistency, passion and determination, values that are reflected in every product we create.

We are among the few Italian companies that manufacture shower enclosures, shower trays and bathroom furniture entirely within the local area, following an in-house process that combines artisanal precision, attention to detail and constant quality and safety controls. Every TDA product is the result of carefully selected materials, up-to-date expertise and distinctive Italian design, created to last over time while respecting the environment.

Our brand dedicated to bathroom furnishings was founded in 1982 under the name **CIMA ARREDOBAGNO**. From the very beginning we focused on everything that could enrich the bathroom environment with colour, materials and innovation: first with furniture, then with shower enclosures, until 2012, when we introduced our exclusive composite material **AROCK®**. This allowed us to create our first shower trays and later countertops and washbasins with a unique design.

For us, Made in Italy is not just a label, but a philosophy: every product is handcrafted with pride in our facilities located just a few kilometres from one another, carrying forward the culture of Brescia and the excellence of Italian bathroom design.

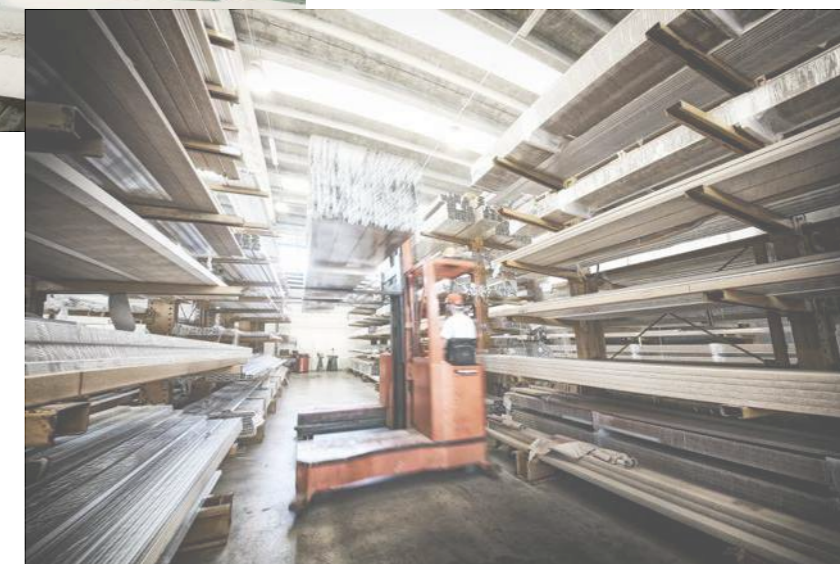
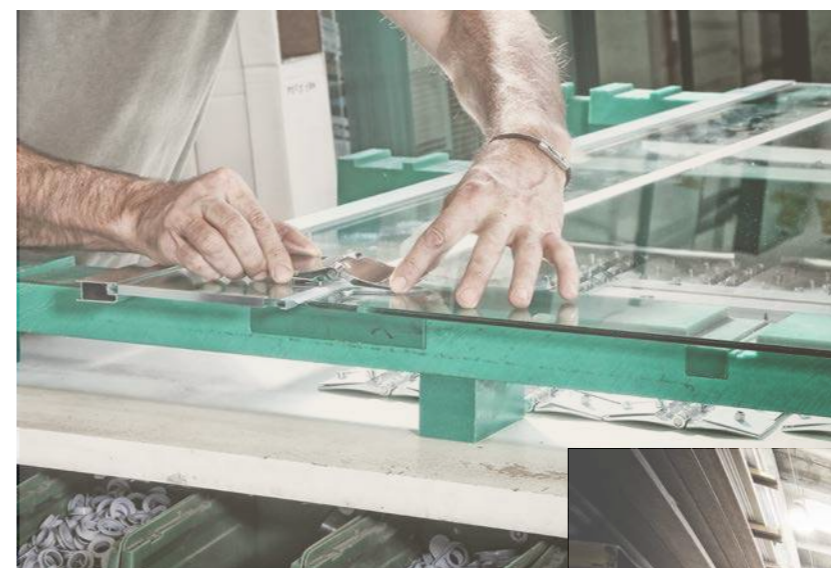

## IMPORTANTE NOTE

### Invio ordini | Sending orders

Gli ordini vanno inviati all'indirizzo e-mail **commerciale@tda.it**

Orders must be sent to the following e-mail address: **commerciale@tda.it**

### Misure | Dimensions

Se non diversamente indicato, nel presente listino prezzi, le misure sono espresse in cm.

Except where stated otherwise, all dimensions in the present price list, are expressed in cm.

### Colori e finiture | Colours and finishes

I colori e le finiture riportati in questo listino prezzi sono da considerarsi indicativi.

La corretta valutazione di colore e tonalità deve sempre far riferimento alla cartella colori in vigore o ai campioni fisici di TDA.

All colours and finishes given in this price list are considered to be indicative.

For an accurate evaluation of colours and shades please refer to the current colour chart or to the TDA physical samples.

## QUALITA' CERTIFICATA e GARANZIA GUARANTEED QUALITY and WARRANTY

Prima di essere destinati alla vendita tutti i prodotti TDA vengono sottoposti a controlli specifici per garantire l'assoluta integrità e la loro conformità. Le pareti doccia TDA rispondono agli standard qualitativi e di sicurezza della normativa europea vigente in materia EN 14428:2018 e sono marcati con la sigla CE sugli imballi. Le versioni in lingua delle differenti DoP (Declaration of Performances) possono essere scaricate dal nostro sito web **www.tda.it**.

TDA garantisce i propri prodotti per 24 mesi a partire dalla data di acquisto secondo le normative Europee vigenti in materia. La garanzia TDA copre esclusivamente i difetti di fabbricazione o di assemblaggio.

Eventuali difetti estetici o strutturali della parete doccia vanno segnalati a TDA per iscritto, a mezzo email o fax, corredati dal documento d'acquisto e da immagini fotografiche. Tutto ciò prima di procedere con il montaggio della parete doccia, qualsiasi difetto segnalato ad avvenuto montaggio non sarà risarcito.

TDA si impegna ad intervenire tempestivamente nel garantire la riparazione o sostituzione degli elementi riconosciuti difettosi. Non sono contemplate eventuali richieste di indennizzo da parte dell'acquirente derivate da disagi e costi aggiuntivi.

Sono esclusi dal servizio di garanzia TDA:

- danni imputabili al trasporto non segnalati per iscritto al trasportatore al momento dello scarico
- rotture dei vetri causate dalla movimentazione manuale o da impatti accidentali durante l'utilizzo
- danni causati da installazioni non eseguite secondo le istruzioni di montaggio TDA
- danni arrecati da interventi di personale non competente e non autorizzato
- difetti del prodotto dovuti alla normale usura oppure a uso improprio da parte del fruitore
- difetti o malfunzionamenti riconducibili all'uso da parte del fruitore di prodotti non idonei per la pulizia
- malfunzionamenti riconducibili a cause di forza maggiore
- manomissioni da parte dell'acquirente.

TDA declina ogni responsabilità per danni a persone, animali e/o cose causati da errate installazioni e/o regolazioni, dallo scorretto utilizzo o da mancate manutenzioni periodiche e dalla mancata scrupolosa osservanza della documentazione allegata al prodotto.

TDA garantisce la disponibilità dei pezzi di ricambio fino a 2 anni dall'uscita di produzione del codice prodotto e successivamente fino a esaurimento delle scorte.

Before being able to place TDA's products on the market for sales to the customers, they are subject to specific quality controls, which guarantee their integrity and conformity to required standards. TDA's shower enclosures respect the quality and safety standards implemented by the European Normative EN 14428:2018. In addition, they are marked by the CE, visible on their packaging. On TDA's website, **www.tda.it**, it is possible to download copies of the DoP (Declaration of Performances) in different languages.

In accordance with the current European Normative, TDA provides warranty on their products for 24 months from the purchasing date. TDA's warranty covers exclusively the defect issues that accrue during the manufacturing or packaging of the products. Potential and external issues related to the design and structure of the shower enclosure need to be documented via email or fax to TDA with attached pictures of the product and purchasing documents. Please consider that TDA needs to receive this documentation before the placement of the shower enclosures. As a result, if anything is reported once the shower enclosures are already installed, the reimbursement will not be processed. TDA is very committed to solve any issue in a timely manner to guarantee either the reparation or replacement of the defective parts and items. Potential requests of reimbursement caused by any sort of inconvenience, additional costs, etc. will not be considered eligible. As follow, a list of items excluded from the services covered by TDA's warranty:

- damages during the products' shipment that has not been reported on a written notice to the freight forwarder at the moment of loading.
- glass' breaking caused either by the manual movements or accidental impacts during the product's usage.
- damages caused by the inappropriate product's placement, which did not follow the correct TDA's instructions for installation.

- damages caused by unqualified and unauthorized personnel
- blemishes caused by the natural wear of the product
- blemishes or malfunctions caused by the inappropriate use and cleanliness of the product by the user
- malfunctions caused by force majeure
- alterations by the buyer.

TDA rejects any responsibility of damages to people, animals, and/or things caused either by wrong installations, the incorrect use of regulations, or the inappropriate use of the product. In addition, TDA is not responsible for damages derived from the buyer's negligence of implementing periodical servicing and overlooking important information and documentation related to the product.

TDA guarantees the availability of replacement parts for 2 years from the launch of the product code's production until the depletion of the stockpiles.

LETTURA DEL LISTINO  
HOW TO READ THE PRICE LIST

**Serie**  
Product line

**Descrizione del modello**  
Model description

**Disegno del modello**  
Model drawing

**Simboli delle caratteristiche**  
Symbols of characteristics

**Installazioni**  
Installations

**Informazioni tecniche**  
Technical info

**Tabella delle info tecniche**  
Technical info table

**N° di colli**  
Number of packages

**Peso lordo**  
Total gross weight

**Elio**  
Parete doccia con porta scorrevole  
Sliding door

**Standard sizes**

| Codice SX<br>LH Code | Codice DX<br>RH Code | estensibilità<br>extension | Finiture profili<br>Profiles finishing | 30 | 16 | 29 | 28 | 31 |
|----------------------|----------------------|----------------------------|--|----|----|----|----|----|
| 03P210100            | 03P200100            | 97,5-99                    | origin<br>abitat<br>vogue              |    |    |    |    |    |
| 03P210110            | 03P200110            | 107,5-109                  | origin<br>abitat<br>vogue              |    |    |    |    |    |
| 03P210120            | 03P200120            | 117,5-119                  | origin<br>abitat<br>vogue              |    |    |    |    |    |
| 03P210130            | 03P200130            | 127,5-129                  | origin<br>abitat<br>vogue              |    |    |    |    |    |
| 03P210140            | 03P200140            | 137,5-139                  | origin<br>abitat<br>vogue              |    |    |    |    |    |
| 03P210150            | 03P200150            | 147,5-149                  | origin<br>abitat<br>vogue              |    |    |    |    |    |
| 03P210160            | 03P200160            | 157,5-159                  | origin<br>abitat<br>vogue              |    |    |    |    |    |

**Special sizes L**

| Codice SX<br>LH Code | Codice DX<br>RH Code | su misura<br>bespoke | Finiture profili<br>Profiles finishing | 30 | 16 | 29 | 28 | 27 | 31 |
|----------------------|----------------------|----------------------|--|----|----|----|----|----|----|
| 03P219001            | 03P209001            | 90 < L < 99          | origin<br>abitat<br>vogue              |    |    |    |    |    |    |
| 03P219001            | 03P209001            | 100 < L < 119        | origin<br>abitat<br>vogue              |    |    |    |    |    |    |
| 03P219001            | 03P209001            | 120 < L < 139        | origin<br>abitat<br>vogue              |    |    |    |    |    |    |
| 03P219001            | 03P209001            | 140 < L < 159        | origin<br>abitat<br>vogue              |    |    |    |    |    |    |

**incluso** / **included**

**disponibile** / **available**

**installazioni**  
in nicchia / niche  
EL-PSC

**informazioni**  
apertura scorrevole / sliding door

|           | X  | A  | F |  |  |  |   |    |
|-----------|----|----|---|--|--|--|---|----|
| 97,5-99   | 43 | 48 |   |  |  |  | 1 | 38 |
| 107,5-109 | 43 | 58 |   |  |  |  | 1 | 42 |
| 117,5-119 | 53 | 58 |   |  |  |  | 1 | 45 |
| 127,5-129 | 53 | 68 |   |  |  |  | 2 | 48 |
| 137,5-139 | 63 | 68 |   |  |  |  | 2 | 51 |
| 147,5-149 | 63 | 78 |   |  |  |  | 2 | 54 |
| 157,5-159 | 63 | 88 |   |  |  |  | 2 | 57 |

X lunghezza parete doccia / shower wall length  
A spazio d'entrata / entrance space  
F lunghezza lato fisso / fixed side length

LETTURA DEL LISTINO  
HOW TO READ THE PRICE LIST

**Modello**  
Model

**Installazioni previste**  
Allowed installations

**Prezzi misure standard**  
Standard size prices

**Rubricatura**  
Index tabs

**Prezzi misure speciali**  
Special size prices

**Note d'attenzione**  
Warning notes

**Approfondimenti**  
Insights

**Indice**  
Index

**Supplementi**  
Supplements

**Legenda vetri e finiture profili**  
Glass and profiles finishes legend

**EL-PSC**  
INSTALLAZIONE IN NICCHIA  
NICHE INSTALLATION

**Misure standard** / **Standard sizes**

| Codice SX<br>LH Code | Codice DX<br>RH Code | estensibilità<br>extension | Finiture profili<br>Profiles finishing | 30 | 16 | 29 | 28 | 31 |
|----------------------|----------------------|----------------------------|--|----|----|----|----|----|
| 03P210100            | 03P200100            | 97,5-99                    | origin<br>abitat<br>vogue              |    |    |    |    |    |
| 03P210110            | 03P200110            | 107,5-109                  | origin<br>abitat<br>vogue              |    |    |    |    |    |
| 03P210120            | 03P200120            | 117,5-119                  | origin<br>abitat<br>vogue              |    |    |    |    |    |
| 03P210130            | 03P200130            | 127,5-129                  | origin<br>abitat<br>vogue              |    |    |    |    |    |
| 03P210140            | 03P200140            | 137,5-139                  | origin<br>abitat<br>vogue              |    |    |    |    |    |
| 03P210150            | 03P200150            | 147,5-149                  | origin<br>abitat<br>vogue              |    |    |    |    |    |
| 03P210160            | 03P200160            | 157,5-159                  | origin<br>abitat<br>vogue              |    |    |    |    |    |

**Misure speciali L** / **Special sizes L**

| Codice SX<br>LH Code | Codice DX<br>RH Code | su misura<br>bespoke | Finiture profili<br>Profiles finishing | 30 | 16 | 29 | 28 | 27 | 31 |
|----------------------|----------------------|----------------------|--|----|----|----|----|----|----|
| 03P219001            | 03P209001            | 90 < L < 99          | origin<br>abitat<br>vogue              |    |    |    |    |    |    |
| 03P219001            | 03P209001            | 100 < L < 119        | origin<br>abitat<br>vogue              |    |    |    |    |    |    |
| 03P219001            | 03P209001            | 120 < L < 139        | origin<br>abitat<br>vogue              |    |    |    |    |    |    |
| 03P219001            | 03P209001            | 140 < L < 159        | origin<br>abitat<br>vogue              |    |    |    |    |    |    |

**attenzione** / **warning**

Il prezzo della L speciale va trovato nella tabella Misure speciali L in base alla L della parete doccia  
Special price for L is to be found in Special sizes L as per L needed size

**Approfondimenti** / **Insights**

Indice / Index: 3  
Legenda simboli / Icons legend: 13  
Profili - Vetri / Profiles - Glasses: 23  
Ricambi / Spare parts: 406  
Profili speciali / Special profiles: 434  
Schede rilievo misure / Measurement form: 444

**supplementi** / **supplements**

Profilo di compensazione 1 cm / Extension profile 1 cm  
Sigillante SPARTAN® / Sealant SPARTAN®

35A020200 €      36B010010 €

**Legenda vetri e finiture profili**  
Glass and profiles finishes legend

| 05                  | 11                                   | 12     | 16       | 24  | 25    | 26   | 27   | 28         | 29   | 30          | 31          | 32     | 34         |
|---------------------|--------------------------------------|--------|----------|---|-------|------|------|------------|------|-------------|-------------|--------|------------|
| acrilico satin      | flack                                | reflex | satinato | nigor   | flute | wave | alon | fumè brown | fumè | trasparente | extrachiaro | cincià | stampato C |
| origin              | abitat                               |        |          | vogue   |       |      |      |            |      |             |             |        |            |
| 59 Nero / 60 Bianco | 27 Tcrom® / 21 Tinnox® / 22 Tbronze® |        |          | 61 Crosatinato / 62 Ororosa / 63 Cromonero / 64 Franciacorta / 65 Flame / 66 Brownie / Colori |       |      |      |            |      |             |             |        |            |

## LETTURA DEL LISTINO

### HOW TO READ THE PRICE LIST

#### Codice articolo | Item code

Ogni parete doccia TDA è corredata da un codice di identificazione per rintracciare i dati di riferimento, dalla fase d'ordine alla consegna, sia dei prodotti standard che di quelli speciali. A fianco ne indichiamo la struttura per un immediato utilizzo.

Every TDA's shower enclosure comes with an identification code in order to be able to trace the necessary data from the order's phase to the delivery for both standard and special products. On the right we give the code structure for immediate use.

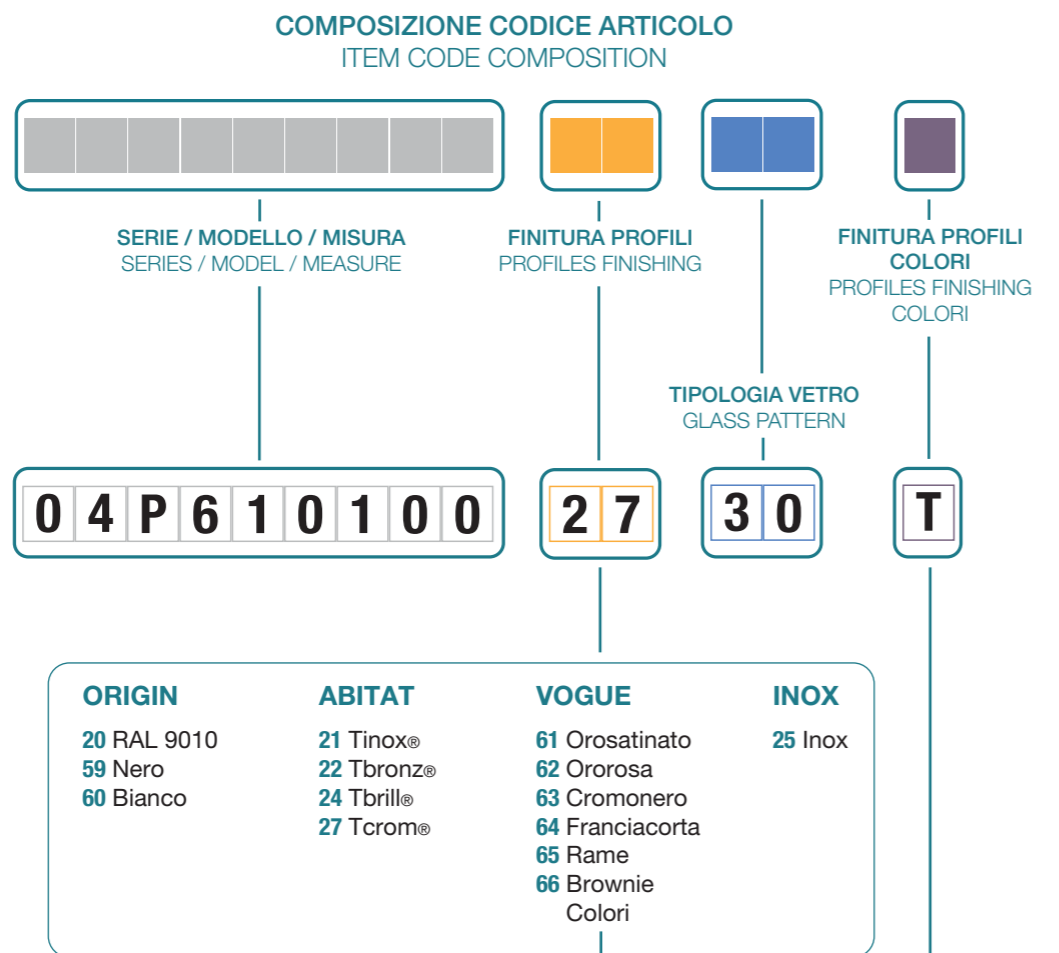

La finitura profili "Colori" è identificata con la lettera "T" alla fine del codice d'ordine  
The profile finish 'Colours' is identified by the 'T' at the end of the order code

#### misure standard | standard sizes

| EL-PSC               |                      |                            | INSTALLAZIONE IN NICCHIA<br>NICHE INSTALLATION |    |    |    |    |
|----------------------|----------------------|----------------------------|--|----|----|----|----|
| Misure standard      |                      |                            | Standard sizes                                 |    |    |    |    |
| Codice SX<br>LH Code | Codice DX<br>RH Code | estensibilità<br>extension | Finiture profili<br>Profiles finishing         | 30 | 16 | 29 | 28 |
| 03P210100            | 03P200100            | 97,5-99                    | origin   |    |    |    |    |
|                      |                      |                            | abitat   |    |    |    |    |
|                      |                      |                            | vogue  |    |    |    |    |
| 03P210110            | 03P200110            | 107,5-109                  | origin   |    |    |    |    |
|                      |                      |                            | abitat   |    |    |    |    |
|                      |                      |                            | vogue  |    |    |    |    |

#### misure speciali | special sizes

| Misure speciali L    |                      |                      | Special sizes L                        |    |    |    |    |
|----------------------|----------------------|----------------------|--|----|----|----|----|
| Codice SX<br>LH Code | Codice DX<br>RH Code | su misura<br>bespoke | Finiture profili<br>Profiles finishing | 30 | 16 | 29 | 28 |
| 03P219001            | 03P209001            | 90 < L < 99          | origin                                 |    |    |    |    |
|                      |                      |                      | abitat                                 |    |    |    |    |
|                      |                      |                      | vogue                                  |    |    |    |    |
| 03P219001            | 03P209001            | 100 < L < 119        | origin                                 |    |    |    |    |
|                      |                      |                      | abitat                                 |    |    |    |    |
|                      |                      |                      | vogue                                  |    |    |    |    |

## LETTURA DEL LISTINO

### HOW TO READ THE PRICE LIST

#### Legenda dei simboli | Symbols legend

Per semplificare la lettura del listino sono presenti simboli che identificano le caratteristiche tecniche di ogni modello.

To simplify reading the price list, there are symbols identifying the technical characteristics of each model.



ICONA GENERICA H cm  
il simbolo indica la presenza di altezze multiple nella serie

GENERIC ICON H cm  
the symbol indicates multiple heights

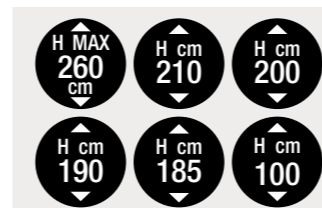

ALTEZZA PARETE DOCCIA  
il simbolo indica l'altezza standard per ogni serie di parete doccia

SHOWER ENCLOSURE HEIGHT  
this symbol indicates the standard height for any shower doors' series

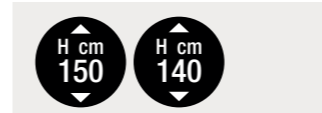

ALTEZZA PARETE SOPRAVASCA  
il simbolo indica l'altezza standard per ogni modello di parete sopravasca

BATHTUB PANEL HEIGHT  
this symbol indicates the standard height for the different bathtub panel models



ICONA GENERICA SP mm  
Il simbolo indica la presenza di diversi spessori delle lastre nella stessa serie

GENERIC ICON SP mm  
the symbol indicates different glass thicknesses in the same series



SPESSORE VETRO  
il simbolo indica lo spessore della lastra in vetro

GLASS DEPTH  
this symbol represents the glass panel's depth



SPESSORE VETRO  
il simbolo indica i due spessori della lastra in vetro entrambi presenti nel modello

GLASS DEPTH  
the symbol indicates the two glass panel thicknesses both present in the model



SPESSORE ACRILICO  
il simbolo indica lo spessore della lastra in acrilico

ACRYLIC DEPTH  
This symbol indicates the acrylic panel's depth



SPESSORE ACRILICO / VETRO  
il simbolo indica che il modello viene realizzato sia con lastra in vetro che in acrilico

ACRYLIC / GLASS DEPTH  
This symbol indicates that the model is made of both glass and acrylic plates



REVERSIBILE  
il simbolo indica che la parete doccia non necessita di informazioni sul verso d'installazione

REVERSIBLE  
this symbol indicates that the shower enclosure does not require information about the installation side



NON REVERSIBILE  
il simbolo indica che la parete doccia necessita di informazioni sul verso di installazione (DX/SX)

NON-REVERSIBLE  
this symbol indicates that the shower enclosure requires information about the installation side (RH/LH)

## LETTURA DEL LISTINO

### HOW TO READ THE PRICE LIST











#### Legenda dei simboli | Symbols legend

|   |   |   |
|---|---|---|
|    | <b>MANIGLIE ESTERNA / INTERNA</b><br>il simbolo rappresenta l'utilizzo di una maniglia doppia per l'apertura dell'anta                            | <b>EXTERNAL / INTERNAL HANDLES</b><br>this symbol represents the double handle's usage for the shower enclosure's opening   |
|    | <b>MANIGLIA ESTERNA / POMOLO INTERNO</b><br>il simbolo rappresenta l'utilizzo di una maniglia esterna con pomolo interno per l'apertura dell'anta | <b>EXTERNAL HANDLE / INTERNAL POMMEL</b><br>this symbol represents the usage of an external handle with internal knob for the shower enclosure's opening            |
|    | <b>POMOLO ESTERNO / INTERNO</b><br>il simbolo rappresenta l'utilizzo di un doppio pomolo per l'apertura dell'anta                                 | <b>EXTERNAL / INTERNAL POMMEL</b><br>the symbol represents the use of a double knob for opening the door  |
|    | <b>POMOLO ESTERNO</b><br>il simbolo rappresenta l'utilizzo di un pomolo esterno per l'apertura dell'anta  | <b>EXTERNAL POMMEL</b><br>the symbol represents the use of an external knob to open the door  |
|    | <b>PROFILO MANIGLIA</b><br>il simbolo rappresenta l'utilizzo di un "profilo maniglia" per l'apertura dell'anta                                    | <b>HANDLE PROFILE</b><br>this symbol represents the handle profile's usage for the door opening   |
|  | <b>ICONA GENERICA EST cm</b><br>Il simbolo indica la presenza di diverse estensibilità nella stessa serie   | <b>GENERIC ICON EST cm</b><br>This symbol indicates the presence of different extensibilities for the same series   |
|  | <b>ESTENSIBILITA' PIENA</b><br>il simbolo rappresenta l'estensibilità con regolazione del fuori squadra massima                                   | <b>FULL EXSTENSIBILITY</b><br>this symbol represents the possibility of the off-square's adjustment with extensibility  |
|  | <b>ESTENSIBILITA' PER LATO</b><br>il simbolo rappresenta l'estensibilità per lato con regolazione del fuori squadra standard                      | <b>SIDE EXTENSIBILITY</b><br>this symbol represents the side extensibility with standard off-square adjustment  |
|  | <b>PROFILO DI COMPENSAZIONE</b><br>il simbolo indica se il profilo è incluso o se disponibile all'acquisto secondo la sua posizione nel listino   | <b>COMPENSATOR PROFILE</b><br>this symbol indicates whether the profile is included or available at the moment of purchasing based on its position on the catalogue |
|  | <b>REGOLAZIONE FUORI SQUADRO</b><br>il simbolo rappresenta la possibilità di regolazione del fuori squadra  | <b>OFF-SQUARE REGULATION</b><br>this symbol represents the possibility of the off-square's adjustment   |

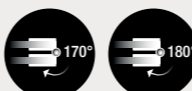
## LETTURA DEL LISTINO

### HOW TO READ THE PRICE LIST

#### Legenda dei simboli | Symbols legend

|   |   |  |
|---|---|--|
|    | <b>PROFILO TENUTA ACQUA BASSO</b><br>il simbolo indica la presenza del profilo di tenuta acqua per la parete doccia           | <b>STANDARD SEAL WATER PROFILE</b><br>this symbol indicates the presence of the seal water profile on the shower enclosure           |
|    | <b>PROFILO TENUTA ACQUA ALTO</b><br>il simbolo indica la presenza del profilo di tenuta acqua maggiorato per la parete doccia | <b>ADVANCED SEAL WATER PROFILE</b><br>this symbol indicates the presence of the increased seal water profile on the shower enclosure |
|    | <b>SGANCIO RAPIDO</b><br>il simbolo segnala la presenza dello sgancio rapido per un accesso facilitato durante la pulizia     | <b>QUICK-RELEASE</b><br>the symbol indicates the presence of the quick release for easy access during cleaning                       |
|    | <b>SGANCIO VITE</b><br>il simbolo segnala la presenza dello sgancio a vite per un accesso facilitato durante la pulizia       | <b>RELEASE SCREW</b><br>the symbol indicates the presence of the screw release for easy access during cleaning                       |
|    | <b>CERNIERA +/- 90°</b><br>il simbolo rappresenta il movimento di apertura in-out o a saloon dell'anta                        | <b>+/- 90° HINGE</b><br>this symbol represents the opening movement of either the in-out or the saloon shower enclosure              |
|  | <b>CERNIERA 170° / 180°</b><br>il simbolo rappresenta il movimento di apertura delle cerniere                                 | <b>170° / 180° HINGE</b><br>this symbol represents the opening movement of the hinge's   |
|  | <b>CERNIERA FILO VETRO</b><br>il simbolo indica il fissaggio a filo vetro di una cerniera all'anta                            | <b>FLUSH HINGE</b><br>this symbol indicates the flush hinge's mounting   |
|  | <b>ROTAZIONE A CAMMA</b><br>il simbolo rappresenta il sollevamento su camme durante la rotazione della cerniera               | <b>CABINET HINGE</b><br>this symbol represents the lifting on cams during the hinge's rotation                                       |
|  | <b>PROFILO MAGNETICO</b><br>il simbolo indica la presenza del profilo in alluminio con magnete                                | <b>MAGNETIC PROFILE</b><br>this symbol indicies the presence of an aluminium profile with magnet                                     |
|  | <b>CHIUSURA MAGNETICA</b><br>il simbolo indica la presenza della chiusura magnetica nell'anta                                 | <b>MAGNETIC CLOSURE</b><br>this symbol indicates the presence of a magnetic closure on the door                                      |
|  | <b>FERMO MAGNETICO</b><br>Il simbolo segnala la presenza del fermo magnetico di allineamento centrale nelle aperture a saloon | <b>MAGNETIC LOCK</b><br>the symbol indicates the presence of the magnetic central alignment latch in saloon openings                 |
|  | <b>FINE CORSA AMMORTIZZATO</b><br>il simbolo rappresenta il movimento rallentato del fincorsa                                 | <b>END BUFFER AND SOFT CLOSING</b><br>this symbol represents the end buffer's slow movement  |

## LETTURA DEL LISTINO

### HOW TO READ THE PRICE LIST







#### Legenda dei simboli | Symbols legend

|   |   |  |
|---|---|--|
|    | <b>CHIUSURA AMMORTIZZATA</b><br>il simbolo rappresenta il movimento di chiusura ammortizzato                            | <b>SOFT CLOSING</b><br>this symbol represents the soft closing movement  |
|    | <b>SBLOCCO MAGNETICO</b><br>il simbolo rappresenta l'apertura di sicurezza con sblocco magnetico                        | <b>MAGNETIC UNLOCK</b><br>this symbol represents the security opening with magnetic unlock   |
|    | <b>SISTEMA SOFT-CLOSE</b><br>il simbolo indica la presenza del movimento soft-close sia in apertura che in chiusura     | <b>SOFT-CLOSE SYSTEM</b><br>this symbol indicates the presence of the soft-close movement for both the opening and the closing         |
|    | <b>GIUNZIONE ANGOLARE</b><br>Il simbolo rappresenta il profilo doppio per la giunzione delle pareti doccia con il fisso | <b>CORNER CONNECTION</b><br>this symbol represents the double profile for the connection of the shower enclosure to the permanent side |
|    | <b>GUARNIZIONE PALLONCINO</b><br>il simbolo indica la presenza della chiusura a palloncino nell'anta                    | <b>BALLOON SEAL</b><br>this symbol indicates the presence of a balloon seal on the door  |
|  | <b>VETRO CURVATO 90°</b><br>il simbolo indica la presenza di un vetro curvo a 90° temprato                              | <b>90° CURVED GLASS</b><br>this symbol indicates the presence of a 90° curved and tempered glass                                       |
|  | <b>APERTURA GIREVOLE</b><br>il simbolo indica la presenza del perno di rotazione per l'anta a battente                  | <b>REVOLVING OPENING</b><br>this symbol indicates the presence of the pivot point for the hinged door                                  |
|  | <b>IN-OUT</b><br>il simbolo rappresenta il movimento di apertura in-out dell'anta a battente                            | <b>IN-OUT</b><br>this symbol represents the hinged door's in-out opening movement  |
|  | <b>PARACOLPI</b><br>il simbolo rappresenta il blocco del finecorsa con paracolpi morbido                                | <b>BUMPERS</b><br>this symbol represents the end buffer's lock with soft bumpers   |
|  | <b>SCORRIMENTO INFERIORE</b><br>Il simbolo indica lo speciale scorrimento su binario inferiore                          | <b>LOWER SLIDING</b><br>this symbol indicates the special sliding on lower track   |
|  | <b>PALO TELESCOPICO</b><br>Il simbolo rappresenta la presenza del palo estensibile fino a soffitto                      | <b>TELESCOPIC POLE</b><br>this symbol represents the presence of an extendible pole to the ceiling                                     |
|  | <b>MISURE SPECIALI</b><br>Il simbolo indica la possibilità di produrre la parete doccia con misure fuori standard       | <b>SPECIAL MEASURES</b><br>this symbol indicates the possibility of producing the shower door with nonstandard measures                |

## LETTURA DEL LISTINO

### HOW TO READ THE PRICE LIST

#### Legenda dei simboli | Symbols legend

|   |   |  |
|---|---|--|
|    | <b>MODELLO SU MISURA</b><br>Il simbolo indica che la parete doccia è prodotta completamente su misura   | <b>CUSTOMIZED MEASURE</b><br>this symbol indicates that the shower door is produced with customized measures   |
|    | <b>PMR</b><br>il simbolo PMR indica i modelli prodotti e consigliati da TDA per persone con mobilità ridotta                                      | <b>PMR</b><br>the PMR symbol indicates the models that TDA produces and recommends to people with mobility impairment  |
|    | <b>DECOGRAFIA</b><br>il simbolo indica se la decografia è disponibile per il modello  | <b>DECOGRAPHY</b><br>this symbol indicates if the decography is available for the specific model   |
|    | <b>TRATTAMENTO NEVERDROP®</b><br>il simbolo indica se il trattamento è incluso o se disponibile all'acquisto secondo la sua posizione nel listino | <b>NEVERDROP® TREATMENT</b><br>this symbol indicates whether the treatment is included or available at the moment of purchasing based on its position on the catalogue |
|    | <b>SPARTAN</b><br>il simbolo indica la disponibilità all'acquisto del sigillante Spartan  | <b>SPARTAN</b><br>This symbol indicates the possibility of purchasing the SPARTAN sealer   |
|  | <b>NUMERO DI COLLI e PESO TOTALE</b><br>i simboli indicano il numero totale di colli e il peso lordo della parete doccia                          | <b>NUMBER OF PACKAGES and TOTAL WEIGHT</b><br>the symbols indicate the total number of packages and the gross weight of the shower enclosure                           |
|  | <b>STOCK</b><br>il simbolo indica la disponibilità a magazzino  | <b>STOCK</b><br>this symbol indicates the warehouse availability   |

## Tipologia | Types

La scelta di una parete doccia rappresenta un momento di forte personalizzazione della stanza da bagno.

Il listino TDA ha individuato tre tipologie che identificano le maggiori esigenze e tendenze di un pubblico globale.

The choice of the shower enclosure is fundamental in the personalization of the bathroom style and design. TDA's catalog identifies three different types of shower enclosures.

These diverse types represent the major trends and needs of the global public.

**walk-in**

|                 |
|-----------------|
| <b>IT</b> Italo |
| <b>VI</b> Vito  |
| <b>RO</b> Rocco |

è la tipologia di parete doccia derivante da un ideale di **libero spazio** e libera installazione. Nei fatti le tre serie qui elencate esaltano il concetto di libertà offrendo la scelta di telaio perimetrale, profilo laterale e fissaggio a soffitto. Nessun ostacolo per il montaggio a centro stanza e un deflettore per chi utilizza fiumi di acqua, acquistabile anche a posteriori.

it is the type of shower enclosure derived from the idea of **free space** and installation. In practice, the three series that we have mentioned enhance the concept of freedom by offering the opportunity to choose between perimetric frame, side profile, and ceiling fastening.

There are no obstacles to assemble the product in the center of the room with a deflector for those that use a lot of water, which can be purchased consequently.

**con profilo verticale / with vertical profile**

|                       |
|-----------------------|
| <b>EN</b> Enzo        |
| <b>FR</b> Frigo       |
| <b>IS</b> Inox Scroll |
| <b>IR</b> Inox Rail   |
| <b>PL</b> Pluma Evo   |
| <b>GA</b> Gaia        |
| <b>MO</b> Mork        |
| <b>MI</b> Mindy       |
| <b>VO</b> Volo        |
| <b>FO</b> Font        |

è la tipologia di parete doccia con un **profilo verticale** e dettagli estetici come cerniere e binari di scorrimento che impreziosiscono e rafforzano il prodotto in assenza di telaio. L'estrema sensazione di leggerezza della parete doccia è trasmessa dalla libertà verticale delle lastre. Lo scorrimento con il pattino autolubrificante garantisce un basso coefficiente d'attrito e una elevata elasticità e sicurezza di movimentazione dell'anta.

is the type of shower enclosure with a **vertical profile** and aesthetic details such as hinges and sliding rails that embellish and strengthen the product in the absence of a frame. The extreme feeling of lightness of the enclosure wall is conveyed by the vertical freedom of the glass panels. The sliding with the self-lubricating skate guarantees a low coefficient of friction and a high elasticity and safety of the door's movement.

**con telaio / with frame**

|                     |
|---------------------|
| <b>EL</b> Elio      |
| <b>OT</b> Ottavio   |
| <b>DM</b> Dado Maxi |
| <b>DN</b> Dino      |
| <b>SD</b> Spado     |
| <b>CO</b> Comfort   |

è la tipologia di parete doccia con un **telaio ornamentale**, in finiture diverse, posto a racchiudere il vetro. Consente l'installazione del prodotto sia con apertura a battente che con apertura scorrevole posizionato in nicchia, ad angolo e a tre lati. Le pareti doccia di grandi dimensioni posate a pavimento così come su piatto hanno un impatto di sicura robustezza.

it is a type of shower enclosure with an **ornamental frame** and different finishes to contain the glass. It enables the product's installation with both hinged opening and slide-opening positioned in the niche, in the corner, or on the three sides. The shower enclosures with large dimensions create a strong effect and give strength to the product. This type of shower enclosures can be placed directly on the floor or on the shower's tray.

## Legenda aperture e Rubricatura | Key to different types of opening and Index tabs

Le tre tipologie di Pareti doccia, Walk-in, con profilo verticale e con telaio, sono identificate dal relativo colore, riportato nella rubricatura del listino con l'obiettivo di agevolarne la lettura.

The three types of shower enclosures, Walk-in, with vertical profile and with frame, are identified by their respective colour, which is shown in the price list heading for easy reading.



| ITALO  | VITO  | ROCCO | ENZO | FRIGO | INOX SCROLL | INOX RAIL | PLUMA EVO | GAIA | MORK | MINDY |
|--|---|-------|------|-------|-------------|-----------|-----------|------|------|-------|
| <b>PARETI DOCCIA WALK-IN</b>                   |   |       |      |       |             |           |           |      |      |       |
| <b>WALK-IN FIXED PANELS</b>                    |   |       |      |       |             |           |           |      |      |       |
| <b>-TO</b>                                     | tondo - installazione laterale - vetro sp. 8 mm<br>round - Walk-in panel - glass thickness 8 mm               |       |      |       |             |           |           |      |      |       |
| <b>-260</b>                                    | H max 260 cm - installazione laterale - vetro sp. 8 mm<br>H max 260 cm - Walk-in panel - glass thickness 8 mm |       |      |       |             |           |           |      |      |       |
| <b>-6</b>                                      | installazione laterale - vetro sp. 6 mm<br>walk-in panel - glass thickness 6 mm                               |       |      |       |             |           |           |      |      |       |
| <b>-8</b>                                      | installazione laterale - vetro sp. 8 mm<br>walk-in panel - glass thickness 8 mm                               |       |      |       |             |           |           |      |      |       |
| <b>-I8</b>                                     | inclinato - installazione laterale - vetro sp. 8 mm<br>walk-in panel - shaped cut - glass thickness 8 mm      |       |      |       |             |           |           |      |      |       |
| <b>-S8</b>                                     | sagomato - installazione laterale - vetro sp. 8 mm<br>walk-in panel - shaped cut - glass thickness 8 mm       |       |      |       |             |           |           |      |      |       |
| <b>-10</b>                                     | installazione laterale - vetro sp. 10 mm<br>walk-in panel - glass thickness 10 mm                             |       |      |       |             |           |           |      |      |       |
| <b>-C6</b>                                     | installazione centrale - vetro sp. 6 mm<br>freestanding panel - glass thickness 6 mm                          |       |      |       |             |           |           |      |      |       |
| <b>-C8</b>                                     | installazione centrale - vetro sp. 8 mm<br>freestanding panel - glass thickness 8 mm                          |       |      |       |             |           |           |      |      |       |
| <b>-C10</b>                                    | installazione centrale - vetro sp. 10 mm<br>freestanding panel - glass thickness 10 mm                        |       |      |       |             |           |           |      |      |       |
| <b>-L6</b>                                     | aggiuntiva laterale - vetro sp. 6 mm<br>additional fixed side panel - glass thickness 6 mm                    |       |      |       |             |           |           |      |      |       |
| <b>B-6</b>                                     | deflettore - vetro sp. 6 mm<br>mobile panel - glass thickness 6 mm  |       |      |       |             |           |           |      |      |       |
| <b>L-6</b>                                     | laterale - vetro sp. 6 mm<br>additional fixed panel - glass thickness 6 mm                                    |       |      |       |             |           |           |      |      |       |
| <b>PARETI DOCCIA APERTURA BATTENTE</b>         |   |       |      |       |             |           |           |      |      |       |
| <b>SHOWER ENCLOSURES / HINGED DOORS</b>        |   |       |      |       |             |           |           |      |      |       |
| <b>-ABA</b>                                    | porta apertura battente - installazione ad angolo<br>hinged door for corner installation                      |       |      |       |             |           |           |      |      |       |
| <b>-PBAF</b>                                   | porta apertura battente - installazione ad angolo<br>hinged door for corner installation                      |       |      |       |             |           |           |      |      |       |
| <b>-PBA</b>                                    | porta apertura battente<br>hinged door  |       |      |       |             |           |           |      |      |       |
| <b>-PIO</b>                                    | porta apertura IN/OUT<br>IN/OUT opening door  |       |      |       |             |           |           |      |      |       |
| <b>-PFL</b>                                    | porta apertura battente + parete fissa in linea<br>hinged door and aligned fixed panel                        |       |      |       |             |           |           |      |      |       |
| <b>-PSA2</b>                                   | doppia porta apertura saloon<br>saloon door   |       |      |       |             |           |           |      |      |       |
| <b>-PSM</b>                                    | porta apertura saloon magnetica<br>saloon door with magnetic closing system                                   |       |      |       |             |           |           |      |      |       |
| <b>-PSO</b>                                    | porta apertura soffietto<br>folding door  |       |      |       |             |           |           |      |      |       |
| <b>-PGI</b>                                    | porta apertura girevole<br>pivoting door  |       |      |       |             |           |           |      |      |       |
| <b>-TBA2</b>                                   | semicircolare - apertura battente - raggio 55 cm<br>quadrant - pivoting door - radius 55 cm                   |       |      |       |             |           |           |      |      |       |
| <b>PARETI DOCCIA APERTURA SCORREVOLE</b>       |   |       |      |       |             |           |           |      |      |       |
| <b>SHOWER ENCLOSURES / SLIDING DOORS</b>       |   |       |      |       |             |           |           |      |      |       |
| <b>-ASC</b>                                    | porta apertura scorrevole - installazione ad angolo<br>sliding door for corner installation                   |       |      |       |             |           |           |      |      |       |
| <b>-PSCF</b>                                   | porta apertura scorrevole - installazione ad angolo<br>sliding door for corner installation                   |       |      |       |             |           |           |      |      |       |
| <b>-PSC</b>                                    | porta apertura scorrevole<br>sliding door   |       |      |       |             |           |           |      |      |       |
| <b>-PSCC</b>                                   | porta centrale apertura scorrevole<br>central sliding door  |       |      |       |             |           |           |      |      |       |
| <b>-PSC2</b>                                   | doppia porta apertura scorrevole<br>double sliding door   |       |      |       |             |           |           |      |      |       |
| <b>-TSC</b>                                    | semicircolare - apertura scorrevole - raggio 80 cm<br>quadrant - sliding door - radius 80 cm                  |       |      |       |             |           |           |      |      |       |
| <b>-T38</b>                                    | semicircolare - apertura scorrevole - raggio 38 cm<br>quadrant - sliding door - radius 38 cm                  |       |      |       |             |           |           |      |      |       |
| <b>-T55</b>                                    | semicircolare - apertura scorrevole - raggio 55 cm<br>quadrant - sliding door - radius 55 cm                  |       |      |       |             |           |           |      |      |       |
| <b>-T61</b>                                    | semicircolare - apertura scorrevole - raggio 61 cm<br>quadrant - sliding door - radius 61 cm                  |       |      |       |             |           |           |      |      |       |
| <b>-GI38</b>                                   | semicircolare - apertura scorrevole - raggio 38 cm<br>quadrant - sliding door - radius 38 cm                  |       |      |       |             |           |           |      |      |       |
| <b>-AR55</b>                                   | semicircolare - apertura scorrevole - raggio 55 cm<br>quadrant - sliding door - radius 55 cm                  |       |      |       |             |           |           |      |      |       |
| <b>PARETI DOCCIA WALK-IN</b>                   |   |       |      |       |             |           |           |      |      |       |
| <b>WALK-IN FIXED PANELS</b>                    |   |       |      |       |             |           |           |      |      |       |
| <b>PARETI DOCCIA CON PROFILO VERTICALE</b>     |   |       |      |       |             |           |           |      |      |       |
| <b>SHOWER ENCLOSURES WITH VERTICAL PROFILE</b> |   |       |      |       |             |           |           |      |      |       |
| <b>PARETI DOCCIA CON TELAIO</b>                |   |       |      |       |             |           |           |      |      |       |
| <b>FRAMED SHOWER ENCLOSURES</b>                |   |       |      |       |             |           |           |      |      |       |

## GUIDA ALLA SCELTA DELLA PARETE DOCCIA

### GUIDE TO CHOOSING A SHOWER ENCLOSURE

#### Abaco | Types

Nella tabella a fianco è possibile individuare con facilità il modello di parete doccia cercato, incrociando la tipologia di **INSTALLAZIONE** con il metodo di **APERTURA**.

In the table opposite you can easily identify the shower partition model you are looking for by cross-referencing the **INSTALLATION** type with the **OPENING** method.

#### LEGENDA | LEGEND :

|             |    |
|-------------|----|
| Italo       | IT |
| Vito        | VI |
| Rocco       | RO |
| Enzo        | EN |
| Frigo       | FR |
| Inox Scroll | IS |
| Inox Rail   | IR |
| Pluma Evo   | PL |
| Gaia        | GA |
| Mork        | MO |
| Mindy       | MI |
| Volo        | VO |
| Font        | FO |
| Elio        | EL |
| Ottavio     | OT |
| Dado Maxi   | DM |
| Dino        | DN |
| Spado       | SD |
| Comfort     | CO |

| APERTURA<br>OPENING                   | parete fissa walk-in<br>walk-in panel   | porta o doppia porta scorrevole<br>sliding door or double door   |  |
|---------------------------------------|---|--|--|
| <b>INSTALLAZIONE<br/>INSTALLATION</b> |   |  |  |
| <b>in nicchia<br/>niche</b><br>       | IT-TO<br>IT-260<br>IT-6<br>IT-8<br>IT-18<br>IT-S8<br>IT-10<br>IT-C8<br>IT-C10 | VI-6<br>VI-8<br>EN-PSC<br>IS-PSC<br>IR-PSC<br>PL-PSC<br>PL-PSC2<br>GA-PSC<br>GA-PSC2<br>EL-PSC<br>EL-PSC2<br>OT-PSC<br>OT-PSC2<br>DM-PSC<br>DM-PSC2<br>DN-PSC<br>DN-PSC2<br>SD-PSC<br>SD-PSC2<br>SD-ASC<br>CO-PSC<br>CO-PSC3 |  |
| <b>ad angolo<br/>corner</b><br>       | IT-TO<br>IT-260<br>IT-6<br>IT-8<br>IT-10<br>VI-6<br>VI-8<br>RO-6              | laterale<br>side<br>   | EN-PSCF<br>IS-PSC<br>IR-ASC<br>PL-PSC<br>PL-PSC2<br>PL-ASC<br>GA-PSC<br>GA-PSC2<br>GA-ASC<br>EL-PSCF<br>EL-PSC<br>EL-ASC<br>OT-PSCF<br>OT-PSC<br>OT-PSC2<br>OT-ASC<br>DM-PSC<br>DM-PSC2<br>DM-ASC<br>DM-PSC<br>DM-PSC2<br>DM-ASC<br>DN-PSC<br>DN-PSC2<br>DN-ASC<br>SD-PSC<br>SD-PSC2<br>SD-ASC<br>DN-PSC2<br>DN-ASC<br>DN-ASC<br>CO-ASC2<br>CO-ASC<br>CO-ASC3<br>CO-ASC4<br>CO-ASC5<br>CO-ASC6 |
| <b>a 3 lati<br/>3 sides</b><br>       | IT-C8<br>IT-C10<br>VI-C8<br>RO-C6   | centrale<br>central<br>  | PL-PSC<br>PL-PSC2<br>PL-ASC<br>GA-PSC<br>GA-PSC2<br>GA-ASC<br>OT-PSCF<br>OT-PSC<br>OT-PSC2<br>OT-ASC<br>DM-PSC<br>DM-PSC2<br>DM-ASC<br>DN-PSC<br>DN-PSC2<br>DN-ASC<br>SD-PSC<br>SD-PSC2<br>SD-ASC<br>CO-ASC2<br>CO-ASC3<br>CO-ASC4<br>CO-ASC5<br>CO-ASC6   |
| <b>semicircolare<br/>quadrant</b><br> |   | IR-TSC<br>DM-T55<br>DM-AR55<br>DM-T38<br>DM-GI38<br>DN-T55<br>DN-T38<br>DN-GI38  | CO-T55E<br>CO-T38E<br>CO-GI38<br>CO-T61  |
| <b>soprasvasca<br/>bathtub</b><br>    | IT-SV   | CO-VSC   |  |

## GUIDA ALLA SCELTA DELLA PARETE DOCCIA

### GUIDE TO CHOOSING A SHOWER ENCLOSURE

| anta battente/girevole<br>hinged/pivoting door  | anta battente IN-OUT<br>IN/OUT hinged door                 | anta saloon<br>saloon door | anta soffietto<br>bi-folding door                              | PMR  |  |
|---|--|----------------------------|--|--|--|
|   |  |                            |  |  |  |
| FR-ABA<br>MO-PBA<br>MO-PFL<br>MI-PBA<br>MI-PFL<br>VO-PBA<br>FO-PBA<br>EL-PBA<br>EL-PBAL           | OT-PBA<br>DM-PGI<br>DN-PGI<br>SD-PGI<br>CO-PGI             | MO-PIO<br>MI-PIO           | MO-PSA2<br>MI-PSA2<br>EL-PSA2<br>DM-PSA2<br>DN-PSA2<br>SD-PSA2 | MI-PSO<br>DM-PSO<br>DM-PSM<br>DN-PSO<br>SD-PSO<br>CO-PSO | VO-PSO<br>VO-PFR<br>VO-PBS<br>VO-PFX<br>CO-1PPI            |
| FR-ABA<br>FR-PBA<br>MO-PBA<br>MO-PFL<br>MI-PBA<br>MI-PFL<br>VO-PBA<br>FO-ABA<br>EL-PBAF<br>EL-PBA | EL-PBAL<br>OT-PBAF<br>DM-PGI<br>DN-PGI<br>SD-PGI<br>CO-PGI | MO-PIO<br>MI-PIO           | MO-PSA2<br>MI-PSA2<br>EL-PSA2<br>DM-PSA2<br>DN-PSA2<br>SD-PSA2 | MI-PSO<br>DM-PSO<br>DM-PSM<br>DN-PSO<br>SD-PSO<br>CO-PSO | VO-PSO<br>VO-PFR<br>VO-PBS<br>VO-PFX<br>CO-1PPI<br>CO-2PPI |
| MO-PBA<br>EL-PBAL<br>DM-PGI<br>DN-PGI<br>SD-PGI<br>CO-PGI   |  |                            | MO-PSA2<br>MI-PSA2<br>DM-PSA2<br>DN-PSA2<br>SD-PSA2            | DM-PSO<br>DN-PSO<br>SD-PSO<br>CO-PSO                     | CO-3PPI  |
| MO-TBA2   |  |                            |  |  |  |
| MO-SV<br>MI-SV  |  |                            |  | CO-SVF   |  |



## Categorie delle finiture | Classification of the finishes

**ORIGIN**

 Fascia di prezzo 1  
 Price range 1

È la riga del listino che comprende le finiture di profilo:

It is the line of the catalog that includes the following finishing:

**20**  
 RAL9010

**59**  
 Nero

**60**  
 Bianco

**ABITAT**

 Fascia di prezzo 2  
 Price range 2

È la riga del listino che comprende le finiture di profilo:

It is the line of the catalog that includes the following finishing:

**21**  
 Tinox®

**22**  
 Tbronz®

**24**  
 Tbrill®

**27**  
 Tcrom®

**VOGUE**

 Fascia di prezzo 3  
 Price range 3

È la riga del listino che comprende le finiture di profilo:

It is the line of the catalog that includes the following finishing:

**61**  
 Orosatinato

**62**  
 Ororosa

**63**  
 Cromonero

Colori

**64**  
 Franciacorta

**65**  
 Rame

**66**  
 Brownie

**INOX**

È la finitura dei profili delle pareti doccia SCROLL e RAIL.

It is the line of the catalog that includes the following finishing:

**25**  
 Inox

## Colori verniciati | Lacquered colours

Il ciclo di verniciatura viene eseguito internamente con impianti all'avanguardia. La finitura superficiale è opaca e include tutti i colori della cartella Colours Trend di TDA. Nella categoria COLORI, tutti i componenti della parete doccia vengono realizzati con lo stesso colore.

The cycle of coating is done internally by advanced systems and machineries. The external finishing is matt and includes all the colors presented on the TDA's colors sample Colours Trend. In the COLOURS category, all shower enclosure components are produced in the same colour.

**ATTENZIONE**  
 Gli stessi colori applicati a materiali diversi possono subire leggere variazioni cromatiche.

**NOTE**  
 Colours can incur slight chromatic changes if applied to different materials.

**ATTENZIONE**  
 I colori e le finiture riportati in questo listino prezzi sono da considerarsi indicativi. La corretta valutazione di colore e tonalità deve sempre far riferimento alla cartella colori in vigore o ai campioni fisici di TDA.

**NOTE**  
 All colours and finishes given in this price list are considered to be indicative. For an accurate evaluation of colours and shades please refer to the current colour chart or to the TDA physical samples.

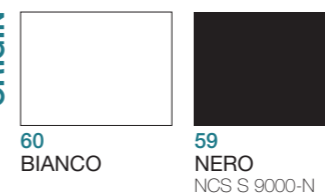
**ORIGIN**

**60**  
 BIANCO

**59**  
 NERO  
 NCS S 9000-N

**VOGUE**

Tabella delle disponibilità | Classification of the finishes

I vetri utilizzati per le pareti doccia TDA sono temprati e rispondenti alla normativa EN 14428:2018. La tempra è un processo chimico-fisico che prevede il riscaldamento del vetro oltre i 600°C e il suo rapido raffreddamento per bloccare le superfici esterne in uno stato di compressione e la parte interna in uno stato di tensione. Terminata la tempra nessuna altra lavorazione come taglio, foratura o molatura dei bordi è eseguibile. Il vetro temprato è considerato di sicurezza perché in caso di rottura si dissolve in piccoli pezzi come previsto dalla normativa citata. Per prevenire il fastidioso accumulo di calcare sui vetri delle pareti doccia, TDA propone Neverdrop® un prodotto altamente performante a base di nanoparticelle.

The glasses utilized for the creation of TDA's shower enclosures follow the EN 14428:2018 Normative. The hardening is a process of chemistry and physics that requires the heating of the glass to reach 600°C and above and its rapid cooling to lock the external surfaces in a compression status and the internal part in a status of tightness. Once the hardening is done, it will be impossible to complete any other processing, such as cutting, drilling, or side grinding. Toughened glass is considered safety glass because it dissolves into small pieces in the event of breakage, as it is outlined in and required by the Normative mentioned above. In order to prevent the annoying accumulation of limestone on the glasses of the shower enclosures, TDA proposes Neverdrop®, a high-performance product made of nanoparticles.

|                          | ITalo | Vito | Rocco | Enzo | Frigo | Inox Scroll | Inox Rail | Pluma Evo | Gaia | Mork | Mindy | Volo | Font | Elio | Ottavio | Dado Maxi | Dino | Spado | Comfort |   |
|--------------------------|-------|------|-------|------|-------|-------------|-----------|-----------|------|------|-------|------|------|------|---------|-----------|------|-------|---------|---|
|                          | IT    | VI   | RO    | EN   | FR    | IS          | IR        | PL        | GA   | MO   | MI    | VO   | FO   | EL   | OT      | DM        | DN   | SD    | CO      |   |
| <b>05</b> Acrilico Satin |       |      |       |      |       |             |           |           |      |      |       |      |      |      |         |           |      |       |         | ● |
| <b>12</b> Reflex         | ●     | ●    | ●     |      |       |             |           | ●         | ●    | ●    | ●     |      |      |      | ●       |           |      |       |         |   |
| <b>16</b> Satinato       | ●     |      | ●     |      |       |             |           | ●         | ●    | ●    | ●     | ●    | ●    | ●    |         | ●         |      |       |         | ● |
| <b>24</b> Nigol          | ●     |      | ●     | ●    |       |             |           |           | ●    |      |       |      | ●    |      | ●       |           |      |       |         |   |
| <b>27</b> Aion           | ●     |      | ●     |      |       |             |           | ●         | ●    | ●    | ●     |      | ●    | ●    |         |           |      |       |         |   |
| <b>28</b> Fumè brown     | ●     | ●    | ●     | ●    |       | ●           |           | ●         | ●    | ●    | ●     |      | ●    | ●    | ●       | ●         |      |       |         |   |
| <b>29</b> Fumè           | ●     | ●    | ●     | ●    |       | ●           |           | ●         | ●    | ●    | ●     |      | ●    | ●    | ●       | ●         |      |       |         |   |
| <b>30</b> Trasparente    | ●     | ●    | ●     | ●    | ●     | ●           | ●         | ●         | ●    | ●    | ●     | ●    | ●    | ●    | ●       | ●         | ●    | ●     | ●       | ● |
| <b>31</b> Extrachiaro    | ●     |      | ●     | ●    |       |             |           |           |      |      |       |      |      | ●    | ●       |           |      |       |         |   |
| <b>25</b> Flute          | ●     |      |       |      |       |             |           |           |      |      |       |      |      |      |         |           |      |       |         |   |
| <b>26</b> Wave           | ●     |      |       |      |       |             |           |           |      |      |       |      |      |      |         |           |      |       |         |   |
| <b>32</b> Cincillà       |       |      |       |      |       |             |           |           |      | ●    | ●     |      |      |      |         | ●         |      |       |         | ● |
| <b>34</b> Stampato C     |       |      |       |      |       |             |           |           |      |      |       |      |      |      |         |           | ●    | ●     |         |   |
| <b>11</b> Flack          | ●     |      |       |      |       |             |           |           |      |      |       |      |      |      |         | ●         |      |       |         |   |
| <b>0A</b> Optical nero   | ●     |      | ●     |      |       | ●           | ●         | ●         | ●    | ●    | ●     | ●    |      |      |         |           |      |       |         |   |
| <b>0B</b> Optical bianco | ●     |      | ●     |      |       | ●           | ●         | ●         | ●    | ●    | ●     | ●    |      |      |         |           |      |       |         |   |
| <b>0E</b> Terra nero     | ●     |      | ●     |      |       | ●           | ●         | ●         | ●    | ●    | ●     | ●    |      |      |         |           |      |       |         |   |
| <b>0F</b> Terra bianco   | ●     |      | ●     |      |       | ●           | ●         | ●         | ●    | ●    | ●     | ●    |      |      |         |           |      |       |         |   |

● Disponibile lastra piana Flat plate available    ● Disponibile lastra piana e curva Flat and curved plate available    ● Tranne misure speciali Except special sizes

Categorie delle finiture | Classification of the finishes

**Lastra ACRILICO**  
ACRYLIC plate

Disponibile in sp. 2,2 mm  
Available in 2.2 mm thickness



**05**  
Acrilico satin / Acrylic satin

**Vetri FLOAT**  
Glass FLOAT

Disponibili in diversi spessori  
Available in different thicknesses

- . 12 - sp. 6 / 8 mm
- . 16 - sp. 4 / 6 / 8 mm
- . 24 - sp. 6 / 8 mm
- . 27 - sp. 6 / 8 mm
- . 28 - sp. 6 / 8 / 10 mm
- . 29 - sp. 6 / 8 / 10 mm
- . 30 - sp. 4 / 6 / 8 / 10 mm
- . 31 - sp. 6 / 8 mm



**12**  
Reflex



**16**  
Satinato



**24**  
Nigol



**Vetri FLOAT**  
Glass FLOAT

Disponibili in diversi spessori  
Available in different thicknesses

- . 12 - sp. 6 / 8 mm
- . 16 - sp. 4 / 6 / 8 mm
- . 24 - sp. 6 / 8 mm
- . 27 - sp. 6 / 8 mm
- . 28 - sp. 6 / 8 / 10 mm
- . 29 - sp. 6 / 8 / 10 mm
- . 30 - sp. 4 / 6 / 8 / 10 mm
- . 31 - sp. 6 / 8 mm



**27**  
Aion



**28**  
Fumè brown



**30**  
Trasparente / Clear



**29**  
Fumè



**31**  
Extrachiaro / Extra clear

**Vetri STAMPATI**  
Patterned glass

Disponibile in sp. 4 / 6 / 8 mm  
Available in 4 / 6 / 8 mm thickness



**25**  
Flute



**26**  
Wave



**32**  
Cincillà  
Altezza massima 200 cm  
Max height 200 cm



**34**  
Stampato C

**Vetri SERIGRAFATI**  
Glass SCREEN PRINTED

Lunghezza massima L 135 cm  
Max length L 135 cm

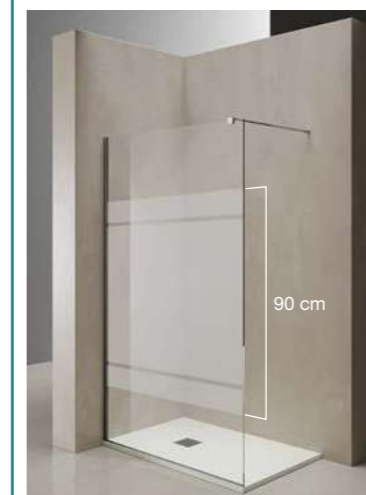

**11**  
Flack

**Vetri DECOGRAFATI**  
Glass DECO PRINTED

Lunghezza massima L 135 cm  
Max length L 135 cm



**0E**

Decografia Terra Nero / Trasparente  
Terra Black Decoprinting / Clear



**1E**

Decografia Terra Nero / Fumè  
Terra Black Decoprinting / Fumè



**0A**

Decografia Optical Nero / Trasparente  
Optical Black Decoprinting / Clear



**1A**

Decografia Optical Nero / Fumè  
Optical Black Decoprinting / Fumè



**0F**

Decografia Terra Bianco / Trasparente  
Terra White Decoprinting / Clear



**1F**

Decografia Terra Bianco / Fumè  
Terra White Decoprinting / Fumè



**0B**

Decografia Optical Bianco / Trasparente  
Optical White Decoprinting / Clear



**1B**

Decografia Optical Bianco / Fumè  
Optical White Decoprinting / Fumè

L'innovazione fa parte del DNA di TDA, soprattutto quando si tratta di semplificare la manutenzione quotidiana delle pareti doccia. Abbiamo adottato quindi due soluzioni tecnologiche all'avanguardia: un **trattamento protettivo** basato su nanotecnologie che ostacola la formazione di calcare sulle superfici vetrate, e un **vetro dotato di speciale finitura antiossidante**, pensato per preservare brillantezza e trasparenza nel tempo.

**Trattamento per il vetro NEVERDROP® | NEVERDROP® glass treatment**

NEVERDROP® è l'esclusivo trattamento per il vetro di TDA. E' un rivestimento nanotecnologico di semplice applicazione che, mediante silice nanostrutturata, forma un film protettivo sulla superficie del vetro riducendo la rugosità media e aumentando la naturale idrorepellenza. Il film che si forma sul vetro agevola lo scivolamento dell'acqua, facilitando la pulizia e impedendo l'adesione di sporco, calcare ed impurità nelle microporosità.

I vetri trattati con NEVERDROP® possono essere puliti con spugne morbide, panni in microfibra o con un tergovetro in silicone. I comuni prodotti per la pulizia sono utilizzabili evitando detersivi in polvere, sostanze fortemente alcaline e mezzi abrasivi. È sempre consigliabile asciugare il vetro dopo l'utilizzo. Si consiglia di ripetere il trattamento annualmente, utilizzando il set acquistabile sul nostro sito web nella sezione ricambi.

**vetro AION | AION glass**

Con il tempo, il vetro esposto ad acqua, calore e umidità può corrodere, compromettendo la sua trasparenza naturale e il suo aspetto estetico. AION è un vetro float chiaro dotato di uno speciale rivestimento progettato per prevenire i processi di corrosione superficiale. Previene l'apparire del velo biancastro provocato dall'usura del vetro. Questo rivestimento è estremamente resistente, non si deteriora e conserva le sue proprietà nel tempo per almeno 10 anni.

L'installazione di AION assicura un ambiente doccia moderno, confortevole e di facile manutenzione. Può essere pulito semplicemente con un panno morbido, acqua e un detersivo neutro. È compatibile con la maggior parte dei prodotti per la pulizia domestica, a eccezione di quelli contenenti polveri abrasive o utensili ruvidi, che potrebbero danneggiare il rivestimento e comprometterne la trasparenza e l'estetica.

**NOTE | NOTE:**

- I trattamenti non eliminano, la pulizia del cristallo, ma la rendono più facile.
- La longevità del trattamento varia in base all'utilizzo della cabina doccia e alla cura con cui viene mantenuta, che deve avvenire con detersivi e mezzi idonei. Anche la composizione chimica dell'acqua, in particolare il suo livello di durezza, può incidere sulle prestazioni e sulla durata dei trattamenti nel tempo.

Innovation is part of TDA's DNA, even when it comes to simplifying the daily maintenance of shower walls. We have adopted two cutting-edge technological solutions: a nanotechnology-based **protective treatment** that hinders the formation of limescale on glass surfaces and a new **glass with a special antioxidant surface**, designed to preserve brilliance and transparency over time.

NEVERDROP® is an exclusive glass treatment by TDA. It is an easy-to-apply nanotechnology coating that uses nanostructured silica to form a protective film on the surface of the glass, reducing average roughness and increasing natural water repellency. The film formed on the glass facilitates the sliding of water, making cleaning easier and preventing dirt, limescale and impurities from adhering in the microporosities.

The glasses with our NEVERDROP® treatment can be cleaned with soft sponges, microfibre cloths or a silicone squeegee. Common cleaning products can be used avoiding powder detergents, strong alkaline substances and abrasive tools. It is always recommended to dry the glass after use. It is also recommended to repeat the treatment every year, using the set available for purchase on our website, in the spare parts section.

Over time, the glass exposed to water, heat and humidity can corrode, compromising its natural transparency and looks. AION is a clear float glass with a special coating, designed to prevent surface corrosion processes. It prevents the appearance of that white-ish veil caused by wear. This coating is extremely resistant, it does not deteriorate and it retains its properties and features for at least 10 years.

Installing AION will make your bathroom a modern, comfortable and easy to maintain. It can be cleaned with ease with a soft cloth, water and neutral detergent. It is compatible with most household cleaning products, with the exception of those containing abrasive powders or rough tools, which could damage the coating and compromise its transparency and aesthetics.

- Having a treated glass doesn't mean one doesn't have to clean it, it's just easier to do it.
- Treatment durability varies according to the use of the shower wall and the care with which it is maintained, which must be done with suitable detergents and means. The chemical composition of the water, in particular its hardness level, can also affect the performance and longevity of treatments.

## MANIGLIE

### HANDLES

Ogni modello di parete doccia è caratterizzato da una maniglia o da un pomolo per l'apertura che ne definiscono, oltre all'estetica, anche la funzionalità.

The handle and the knob define the esthetic and functionality of the shower enclosure's opening.

- A** Maniglia in lega metallica doppia - lunghezza 32 cm  
Double metal alloy handle - length 32 cm
- B** Maniglia in lega metallica con pomolo interno - lunghezza 32 cm  
Metal alloy handle with internal knob - length 32 cm
- C** Maniglia in alluminio doppia - lunghezza 19,5 cm  
Double aluminium handle - length 19.5 cm
- D** Maniglia in lega metallica con pomolo interno - lunghezza 16 cm  
Metal alloy handle with internal knob - length 16 cm
- E** Maniglia in acciaio inox doppia - lunghezza 40 cm  
Inox steel handle with internal grip - length 40 cm
- F** Maniglia in acciaio inox con presa interna - lunghezza 90 cm  
Inox steel handle with internal grip - length 90 cm
- G** Maniglia in alluminio sganciabile - lunghezza 18 cm  
Detachable aluminium handle - length 18 cm
- H** Maniglia in lega metallica doppia - lunghezza 25 cm  
Double metal alloy handle - length 25 cm
- I** Maniglia in lega metallica con presa interna  
Metal alloy handle with internal grip
- L** Profilo maniglia in alluminio  
Aluminium handle profile
- M** Maniglia in alluminio doppia - lunghezza 50 cm  
Double aluminium handle - length 50 cm



|   | EN | FR | IS | IR | PL | GA | MO | MI | VO | FO | EL | OT | DM | DN | SD | CO |
|---|----|----|----|----|----|----|----|----|----|----|----|----|----|----|----|----|
| A |    |    |    |    | •  | •  | •  | •  |    | •  |    | •  | •  |    |    |    |
| B |    |    |    |    | •  | •  |    |    |    | •  |    | •  | •  |    |    |    |
| C | •  |    |    |    |    |    |    |    |    |    |    |    |    |    |    |    |
| D |    |    |    |    |    |    |    |    |    |    |    |    |    |    | •  |    |
| E |    |    | •  |    |    |    |    |    |    |    |    |    |    |    |    |    |
| F |    |    |    | •  |    |    |    |    |    |    |    |    |    |    |    |    |
| G |    |    |    |    |    |    |    |    | •  |    |    |    |    |    |    |    |
| H |    |    |    |    |    |    |    |    | •  |    |    |    |    |    |    |    |
| I |    | •  |    |    |    |    |    |    |    |    |    |    |    |    |    |    |
| L |    |    |    |    |    |    |    |    |    |    |    |    |    | •  |    | •  |
| M |    |    |    |    |    |    |    |    |    |    | •  |    |    |    |    |    |

## CERNIERE

### HINGES

La cerniera definisce l'estetica e la tipologia di apertura di una parete doccia. TDA propone variazioni: con rotazione su camma, con fissaggio a filo vetro, con rotazione di 90°/110°/150°/170°/180°.

The hinge defines the aesthetics and type of opening of a shower enclosure. TDA offers variations: with rotation on cam, with flush mouth glass, with either 90°/110°/150°/170°/180° rotation.

- A** Cerniera in lega metallica con apertura 170°  
Metal alloy hinge with 170° opening
- B** Cerniera in lega metallica regolabile con apertura 110°  
Adjustable metal alloy hinge with 110° opening
- C** Cerniera in lega metallica a camme con apertura 180°  
Metal alloy cam hinge with 180° opening
- D** Cerniera in lega metallica a camme con apertura +/-90°  
Cam metal alloy handle with +/- 90° opening
- E** Cerniera in lega metallica ammortizzata con apertura 110°  
Amortized metal alloy hinge with 110° opening
- F** Cerniera in lega metallica con apertura 170°  
Metal alloy hinge with 170° opening
- G** Cerniera in lega metallica con apertura 150°  
Metal alloy hinge with 150° opening

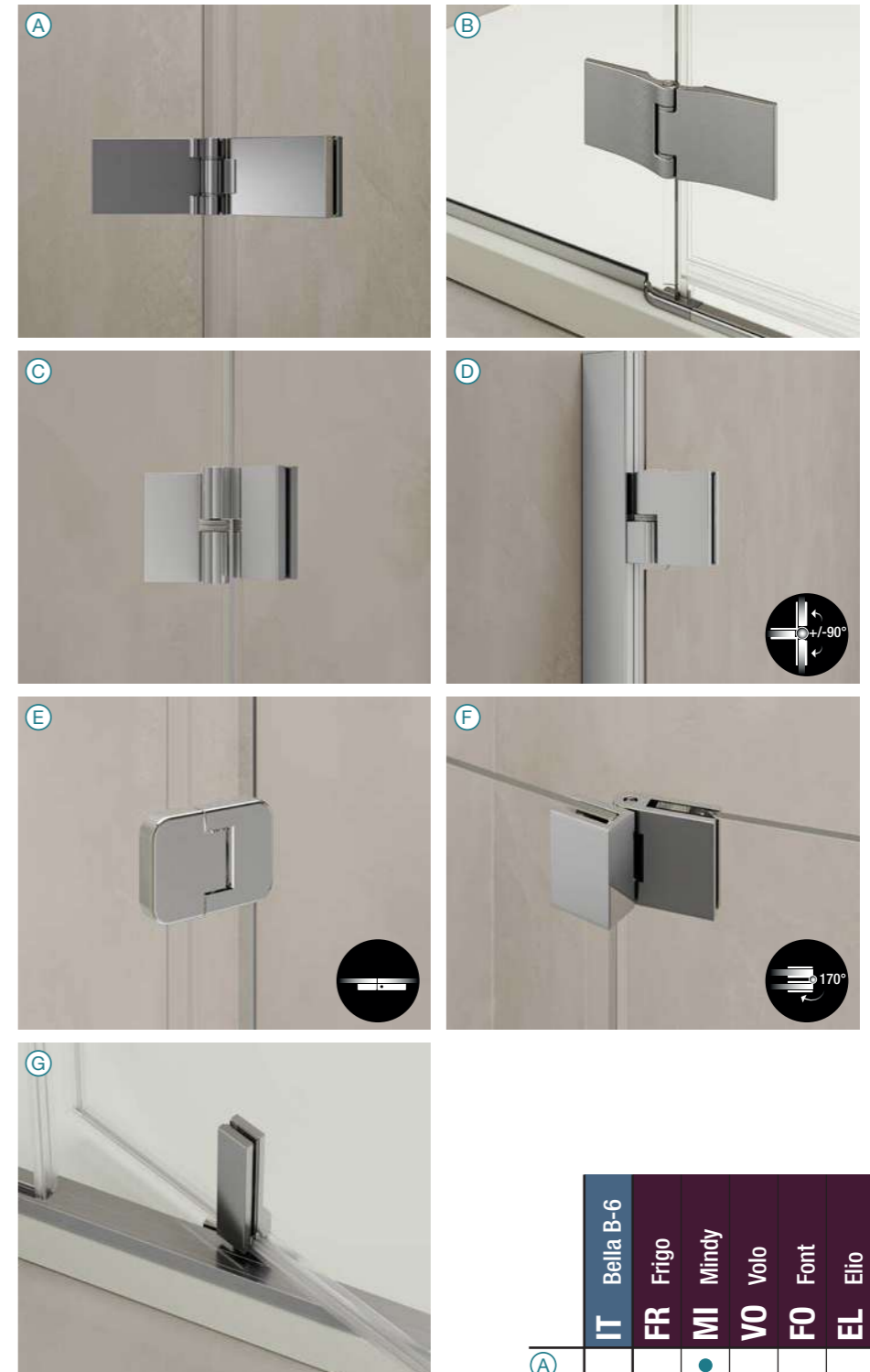

|   | IT | FR | MI | VO | FO | EL | OT | DM |
|---|----|----|----|----|----|----|----|----|
| A |    |    | •  |    |    |    | •  | •  |
| B |    |    |    |    | •  |    |    |    |
| C |    |    |    | •  |    |    |    |    |
| D |    |    |    | •  |    |    |    |    |
| E |    | •  |    |    |    |    |    |    |
| F | •  |    |    |    |    |    |    |    |
| G |    |    |    |    |    | •  |    |    |

Indicazioni per una corretta installazione | Guidelines for correct installation

Le estensibilità delle pareti doccia TDA sono definite per l'installazione STANDARD su piatto doccia. In caso di installazioni diverse, è necessario specificarlo in fase d'ordine oltre che a procedere con un corretto rilievo delle misure.

The extensibility of TDA shower enclosure is defined for STANDARD installation on a shower tray. In the case of different installations, this must be specified in the order as well as a correct measurement.

Schema per presa misure / STANDARD installation

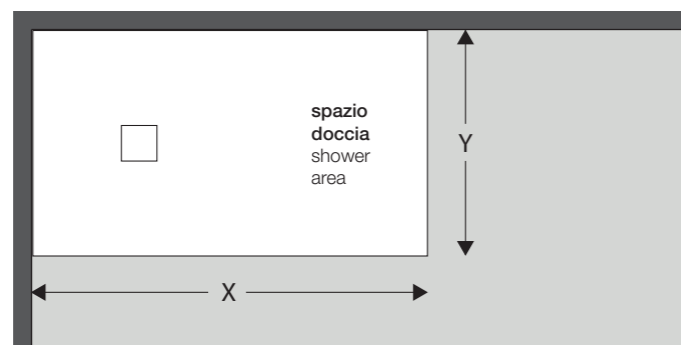

installazione STANDARD / STANDARD installation

la parete doccia è installata all'interno dello spazio doccia, sia su piatto doccia che a pavimento  
the shower enclosure is installed within the shower space, either on a shower tray or on the floor



installazione ESTERNA / EXTERNAL installation

la parete doccia è installata completamente all'esterno dello spazio doccia  
the shower enclosure is installed completely outside the shower space

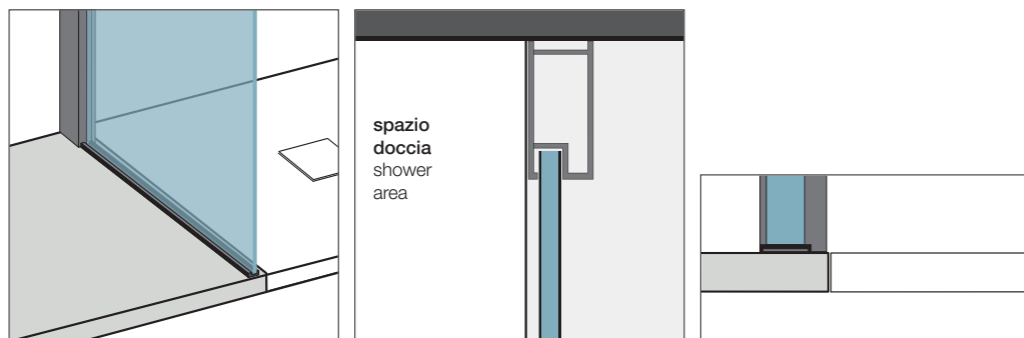

installazione FILO PAVIMENTO / FLOOR installation

la parete doccia è installata con il vetro sulla mezzera della fuga tra spazio doccia e pavimento  
the shower enclosure is installed with the glass on the centreline of the joint between the shower space and the floor

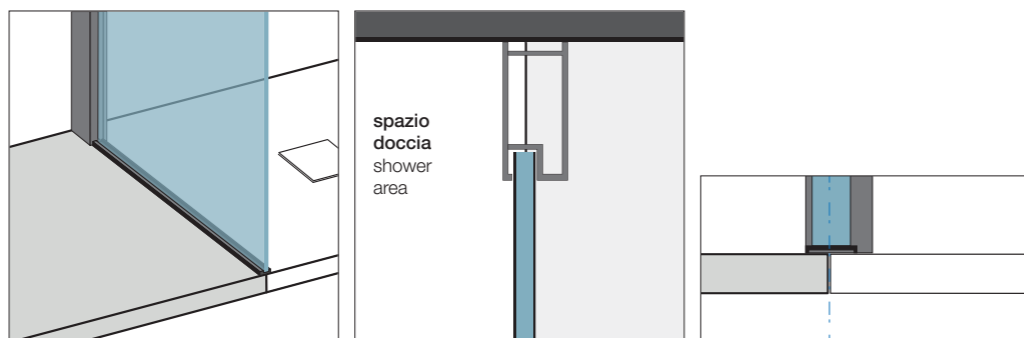

Indicazioni per un corretto rilievo misure | Guidelines for correct measurement

Prima di procedere all'ordine del prodotto è indispensabile effettuare il corretto rilievo delle misure, sia della zona doccia che delle pareti ad essa contigue. Sono disponibili, sul sito [www.tda.it](http://www.tda.it), le [schede rilievo misure] in formato elettronico pre-compilate di ogni modello. Le stesse possono essere scaricate, completate e inviate a mezzo e-mail.

Before proceeding with the product's order, it is fundamental to conduct the metric survey of both the zone allocated for the shower and its contiguous sides. On TDA's website, [www.tda.it](http://www.tda.it), it is possible to find the complete metric survey forms for each model. In addition, they can also be downloaded, filled out, and sent out via e-mail.

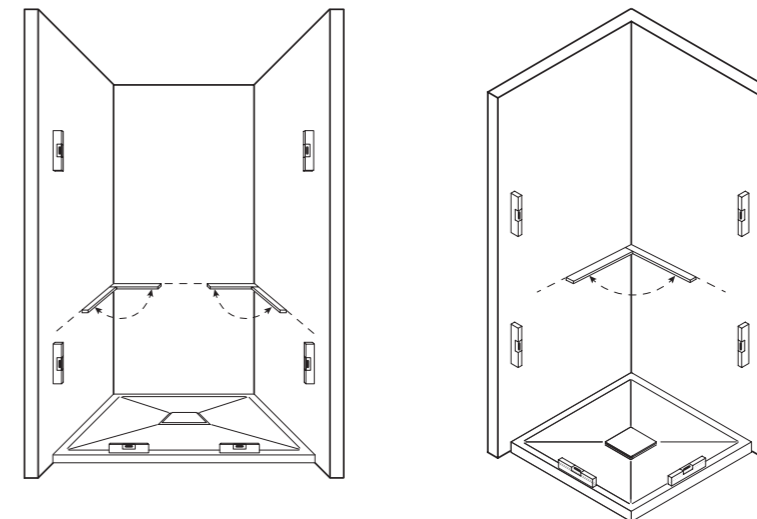

Rilievo livelli orizzontali / Metric horizontal survey

- . le misure vanno rilevate solo con il piatto doccia o pavimento posati
- . le misure sono valide solo con piatto doccia o pavimento perfettamente orizzontale (in bolla)
- . il piatto doccia deve avere un bordo largo almeno 5 cm, diversamente va evidenziato sulla scheda rilievo

- . the measures need to be taken only including either the shower tray or the floor
- . the measures are valid only with the shower tray or the floor perfectly horizontal (bubble level)
- . the shower tray needs to have a side of at least 5cm, otherwise, it needs to be indicated on the form

Rilievo livelli verticali / Metric vertical survey

- . le misure vanno rilevate solo a posa avvenuta del rivestimento delle pareti
- . le misure sono valide solo con muri perfettamente a piombo con il pavimento e ad angolo retto tra loro
- . eventuali fuori piombo vanno correttamente segnalati comunicando valori e direzioni delle inclinazioni delle pareti
- . comunicare con un disegno tecnico l'eventuale presenza di ostacoli sulle pareti come torelli o rilievi

- . the measures can be taken only when the shower enclosures' covering is included
- . the measures are valid only when the walls are perfectly aligned to the floor creating a 90-degree angle between them
- . potential unalignments need to be reported including values and directions of the walls' inclinations
- . it is requested to communicate and report with the technical drawing the possible existence of barriers on the walls

TDA prende in considerazione solo ordini scritti con le misure richieste indicate con chiarezza. L'installazione dei prodotti deve essere eseguita da personale specializzato e con materiali idonei. TDA non è responsabile di malfunzionamenti o perdite d'acqua derivanti da:

- . installazioni su supporti non perfettamente a bolla e/o a piombo se non segnalati in fase d'ordine
- . installazioni non effettuate secondo le istruzioni di montaggio contenute nell'imballo
- . manomissioni di parti del prodotto

TDA considers only orders that include clear and correct measurements. The products' installation needs to be completed by specialized personnel and with adequate materials.

TDA is not responsible for malfunctions or water leaks caused by:

- . installations on unaligned support, if not indicated during the completion of the order's process
- . installations that are not completed based on the correct instructions for the product's assembly, which are included in the product's packaging
- . tampering of the product

Dimensioni speciali | Special sizes

Le pareti doccia di TDA possono essere personalizzate con misure diverse da quelle standard. È sempre necessario rilevare tutte le quote e inviare richiesta di fattibilità all'ufficio tecnico TDA. È consigliabile utilizzare le schede di rilievo misure presenti sul sito internet [www.tda.it](http://www.tda.it).

TDA shower enclosures can be customised with measurements other than the standard ones. It is always necessary to survey all dimensions and send a feasibility request to the TDA technical department. It is advisable to use the measurement sheets on the website [www.tda.it](http://www.tda.it).



[Misure speciali] sono tutte le variazioni in altezza **H** (superiore e inferiore), in larghezza **L** (maggiore e minore) e per forme particolari come sagomature, tagli e smussi.

[Special sizes] indicate all changes in **H** (top and bottom), in **L** (over and under std) and customized shapes such as diagonal cuts, straight cuts and chamfers.

Inclinazioni, muretti e sopravasca | Inclines, walls and bathtubs

Anche nel caso di installazioni particolari come inclinazioni, muretti e vasche è sempre necessario rilevare tutte le quote e inviare richiesta di fattibilità all'ufficio tecnico TDA.

Even in the case of special installations, such as inclines, walls, and baths, it is necessary to measure all the quotes and send a request of feasibility to TDA's technical office.

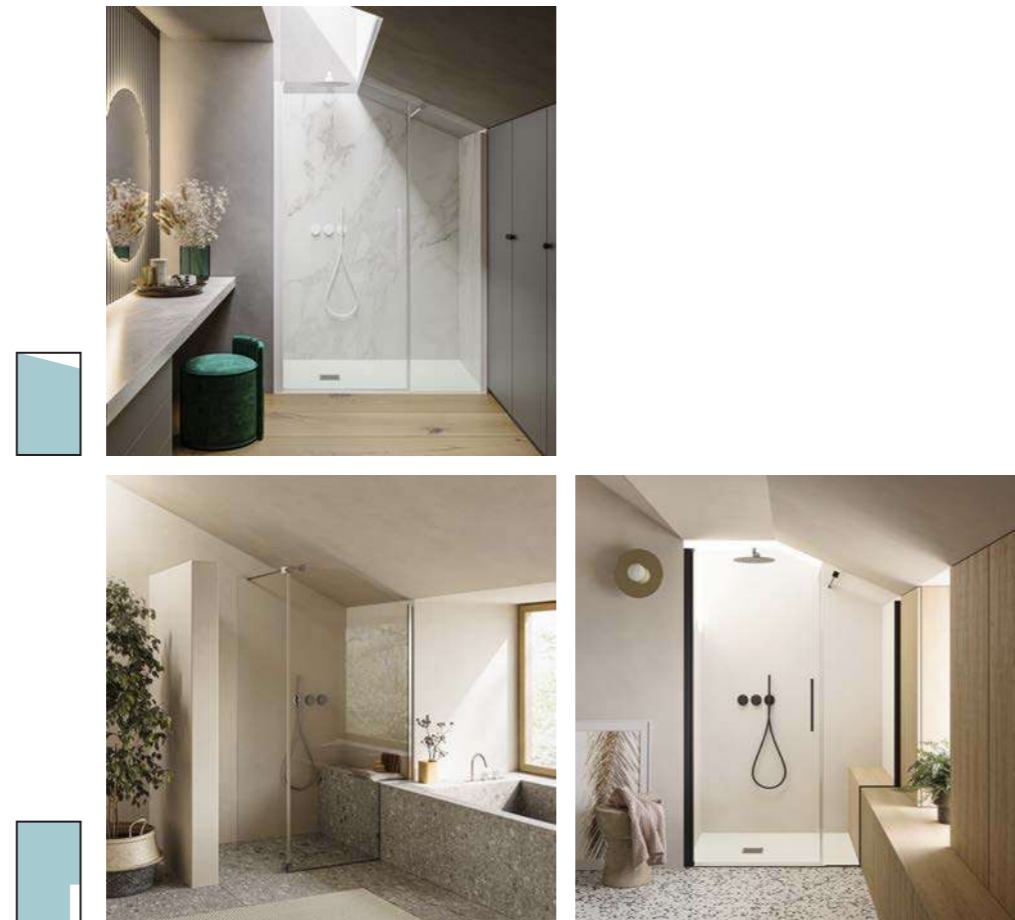

Documentazione tecnica dal sito web [www.tda.it](http://www.tda.it) | Technical documentation from the website [www.tda.it](http://www.tda.it)

Per ogni modello di parete doccia, è possibile scaricare tutto il materiale tecnico necessario per una corretta installazione, per il rilievo misure, per l'esploso dei componenti oltre alla DOP (Dichiarazione di prestazioni).

For each shower enclosure model, it is possible to download all the technical material required for correct installation, the measurement survey, the exploded view of the components as well as the DOP (Declaration of Performance).



Istruzioni per il montaggio (presenti anche nell'imballo)

Assembly instructions (also in the packaging)

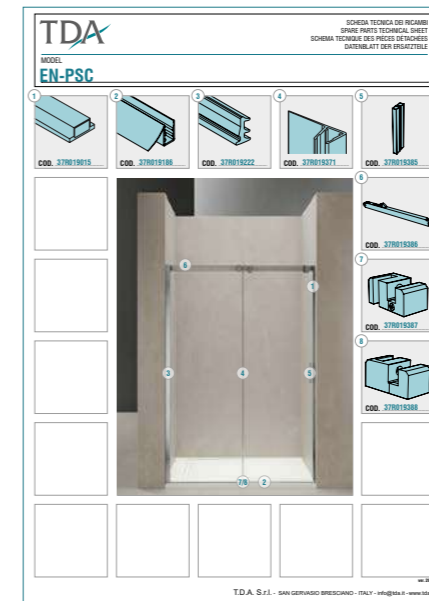

Scheda tecnica dei ricambi

Spare parts technical sheet

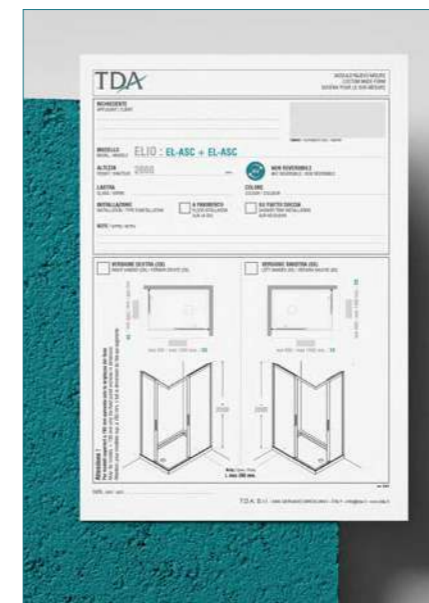

Scheda precompilata per il rilievo misure

Pre-filled sheet for the measurement survey

Pulizia e cura | Cleaning and care

Per mantenere in buono stato i diversi componenti di una parete doccia è importante il risciacquo dopo ogni utilizzo, che elimina i residui di detergenti da vetri e profili, oltre all'asciugatura accurata con un panno morbido. Se si desidera procedere con una pulizia più accurata devono essere comunque evitati solventi, sgrassatori o abrasivi che possano danneggiare irreparabilmente la parete doccia.

Utilizzare preferibilmente spugne o panni morbidi e prodotti neutri e delicati.

I vetri trattati con Neverdrop®, puliti e asciugati al termine di ogni utilizzo con panno morbido, mantengono stabile il loro aspetto; eventuali depositi di calcare possono essere rimossi con il kit di rimozione del calcare TCB taking Care of Bathroom di TDA. Si consiglia di ripetere, almeno una volta all'anno, il trattamento Neverdrop®.

In order to keep the various components of a shower enclosure in good condition, it is important to rinse after each use, which removes detergent residues from glass and profiles, as well as to dry thoroughly with a soft cloth. If more thorough cleaning is desired, however, solvents, degreasers or abrasives that can irreparably damage the shower enclosure should be avoided. Preferably use soft sponges or cloths and mild, neutral products. Glass treated with Neverdrop®, cleaned and dried at the end of each use with a soft cloth, maintains its stable appearance. any limescale deposits can be removed with the TCB taking Care of Bathroom limescale removal kit. It is advisable to repeat the Neverdrop® treatment at least once a year.

Tenuta all'acqua | Water resistance

La ritenzione dell'acqua di una parete doccia è la sua capacità di trattenere l'acqua all'interno dell'area designata. Per garantire una buona tenuta, è fondamentale seguire correttamente le istruzioni di montaggio e assicurare una perfetta sigillatura tra muro, piatto doccia e parete doccia.

La tenuta all'acqua tra vetri e profili viene garantita in fase di produzione grazie a sigillanti e guarnizioni specifiche. Tuttavia, la capacità di ritenzione dell'acqua sulla porta può variare in base alle diverse configurazioni costruttive.

Secondo la normativa EN 14428:2018, un test di ritenzione deve essere eseguito seguendo le indicazioni dell'articolo 5.7. La stessa normativa stabilisce che "poche gocce d'acqua all'esterno dell'area di ritenzione sono accettabili".

The water retention of a shower enclosure is its ability to retain water within the designated area. To ensure a good seal, it is essential to follow the installation instructions correctly and to ensure a perfect seal between the wall, shower tray and shower enclosure.

The water tightness between the glass and profiles is guaranteed during production by means of specific sealants and gaskets. However, the water retention capacity of the door may vary according to different construction configurations.

According to EN 14428:2018, a retention test must be carried out according to Article 5.7. The same standard states that "a few drops of water outside the retention area are acceptable".

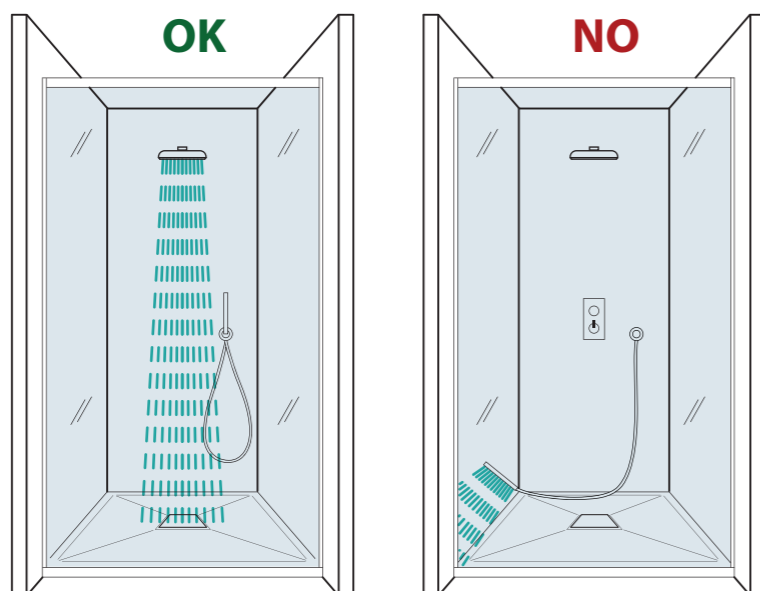

Prodotti consigliati | Recommended products

**Sigillante SPARTAN®**  
Sealant SPARTAN®



Codice  
Code  
**36B010010**

Sigillante cristallino a base di puro polimero MS; completamente trasparente dopo l'asciugatura, Spartan® crea incollaggi invisibili, non ingiallisce ed offre un'altissima tenuta meccanica: 25 Kg/cm<sup>2</sup>. Grazie alla formulazione neutra, Spartan® è senza solventi, senza odore, non ritira durante l'asciugatura e dopo l'apertura si conserva per diversi mesi. Attenersi scrupolosamente alle indicazioni d'uso presenti sull'etichetta della cartuccia.

The crystalline sealant, made of pure polymer MS and completely transparent once it dries, Spartan® creates invisible bonding and does not get yellow with the time.

In addition, it offers a high mechanic resistance: 25 Kg/cm<sup>2</sup>. Moreover, thanks to the neutral formulation, Spartan® does not have solvents, it does not create odors, it does not shrink during the drying process and preserves its quality, once it is opened and exposed.

Complying with the indications on how to use the product written on the label is fundamental.

**Trattamento per il vetro NEVERDROP®**

Treatment NEVERDROP®



Codice  
Code  
**36A010004**

NEVERDROP® è un innovativo rivestimento per il vetro a base di composti organici e inorganici di nanoparticelle, che formano un sottile e trasparente film protettivo sulla superficie del vetro rendendola così facilmente pulibile e altamente idrofobica. Il deposito superficiale può essere facilmente rimosso con un semplice panno umido e senza bisogno di detergenti specifici.

Il trattamento NEVERDROP® non è un trattamento definitivo, la durata del suo effetto dipende dalla frequenza d'uso della parete doccia, dalla sua manutenzione e dalla durezza dell'acqua.

Si consiglia di ripetere il trattamento annualmente utilizzando il set presente nel nostro listino.

NEVERDROP® is an innovative glass's covering made of organic components. In addition, this material contains nonorganic nanoparticles that create a thin and transparent protective layer on the surface of the glass making it very simple to be cleaned and highly hydrophobic. The leftovers on the surface can be easily removed with a wet wipe without the need of specific cleaners. The NEVERDROP®'s treatment is not definitive. Its effect's duration depends on both how often the product is used, how the product is maintained, and the water's quality. Once again, it is advisable to repeat the treatment once a year using the cleaning kit provided on our catalog.

**TCB Taking Care of Bath**



Codice  
Code  
**36A010010**

Kit di rimozione del calcare per superfici in vetro e AROCK®.

Contiene due prodotti: **Tclean** detergente sgrassatore e **Tcalc** anticalcare.

**Tclean** è un detergente idoneo per la pulizia di superfici in vetro e in Arock®. Scioglie, in modo rapido ed efficace, grassi, residui saponosi, liquidi organici, sporco atmosferico e sostanze alimentari. Sgrassa a fondo senza intaccare le superfici. E' un prodotto a schiuma controllata, pronto all'uso, in diluizione corretta per l'ambiente bagno.

**Tcalc** è un prodotto specifico per la rimozione di residui di calcare da superfici in vetro e in Arock®. Scioglie, completamente e in modo rapido, le incrostazioni calcaree causate da acqua o sostanze simili senza intaccare le superfici. E' un prodotto denso, pronto all'uso, che forma un aggrappaggio perfetto anche su superfici verticali.

Limescale removal kit for glass and AROCK® surfaces.

It contains two products: **Tclean** degreasing cleaner and **Tcalc** limescale remover.

**Tclean** is a detergent suitable for cleaning glass and Arock® surfaces. It dissolves quickly and efficiently soap residue, organic liquids, atmospheric dirt and food substances. It thoroughly degreases without affecting surfaces. It is a low foaming ready-to-use product specially diluted for the bathroom environment.

**Tcalc** is a specific product for removal of limescale residues from glass and Arock® surfaces. It dissolves quickly and completely limescale caused by water or similar substances without affecting the surfaces. It is a dense, ready-to-use product which forms a perfect grip also on vertical surfaces.

La sezione ricambi del sito [www.tda.it](http://www.tda.it) consente di individuare il modello della vostra parete e acquistare direttamente i pezzi di ricambio.

Il nostro catalogo online comprende la maggior parte dei componenti utilizzati per l'assemblaggio delle pareti doccia TDA, fissaggi, guide, perni, guarnizioni, maniglie, particolari, profili e scorrimenti.

Garantire la massima qualità nei prodotti è la nostra priorità, ecco perché vogliamo dare ai clienti la massima serenità anche nel post-vendita, garantendo ricambi originali e selezionati.

Il nostro e-shop ha un'interfaccia semplice, che ti permetterà di risparmiare moltissimo tempo nella ricerca del pezzo che desideri.

The replacement's section on our website, [www.tda.it](http://www.tda.it), helps the clients identify the model of their shower enclosures and directly purchase the replacement parts.

Our product range includes most of the components used to assemble TDA's shower walls, like fastening elements, guides, pivots, seals, handles, sliders and other elements.

We guarantee top-quality products, as well as original and highly selected spare parts, with the aim to want to keep our clients satisfied with our after-sale service too.

For our e-shop we chose a simple interface, which will allow you to find the part you are looking for in a really short time. It's quick and convenient.

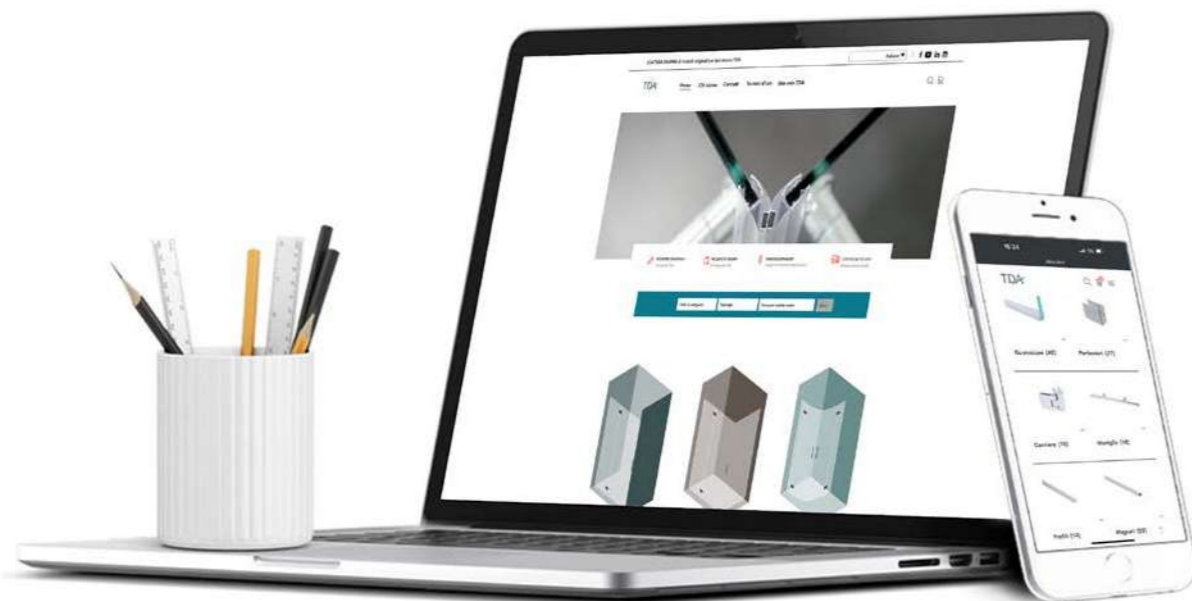

TDA dispone di una selezione di campionari pensati per supportare concretamente l'attività di vendita. Strumenti pratici che permettono di presentare al cliente finale materiali, finiture e soluzioni disponibili, facilitando la scelta attraverso un'esperienza visiva e tattile.

TDA provides a selection of sample kits designed to effectively support the sales process. Practical tools that allow the presentation of available materials, finishes, and solutions to the end customer, facilitating the selection process through both visual and tactile experience.

#### CARTELLA CAMPIONARIO | SAMPLE FOLDER



La **Cartella Campionario** rappresenta lo *starter kit* ideale per il cliente che desidera uno strumento di supporto alla vendita semplice, pratico e immediato. All'interno della cartella sono raccolte le immagini di tutte le tipologie di vetro disponibili, affiancate dai campioni fisici delle finiture dei profili. Una soluzione compatta e funzionale, pensata per avere sempre a disposizione una panoramica chiara e veloce della gamma.

The **Sample Folder** represents the ideal *starter kit* for customers who require a simple, practical, and immediate sales support tool. Inside the folder, images of all available glass types are presented together with physical samples of the profile finishes. A compact and functional solution designed to provide a clear and quick overview of the entire range at any time.

Codice €  
Code

[36A010050](#)

#### BLACK-BOX | BLACK-BOX



La **Black-Box Pareti Doccia** è il campionario più completo della nostra collezione, progettato per offrire una visione approfondita dei materiali e delle finiture TDA. Al suo interno sono presenti i campioni fisici di tutte le tipologie di vetro e di tutte le finiture dei profili utilizzati per la produzione delle nostre pareti. La dotazione comprende inoltre una mazzetta dedicata alle grafiche dei vetri serigrafati e decografati, oltre ai campioni fisici delle texture dei piatti doccia realizzati in Arock®. Per la definizione precisa di tutti i colori disponibili, sia per i profili sia per i piatti doccia, il riferimento ufficiale resta sempre la nostra mazzetta colori in vigore.

The **Black-Box Shower Enclosures** is the most comprehensive sample kit in our collection, designed to offer an in-depth overview of TDA materials and finishes. It includes physical samples of all available glass types and all profile finishes used in the production of our shower enclosures. The kit also contains a sample fan dedicated to the graphics of our screen-printed and decorative glass, together with physical samples of the textures of our shower trays made in Arock®. For the precise definition of all available colours - both for profiles and shower trays - reference should always be made to our current official colour sample fan.

Codice €  
Code

[36A010060](#)

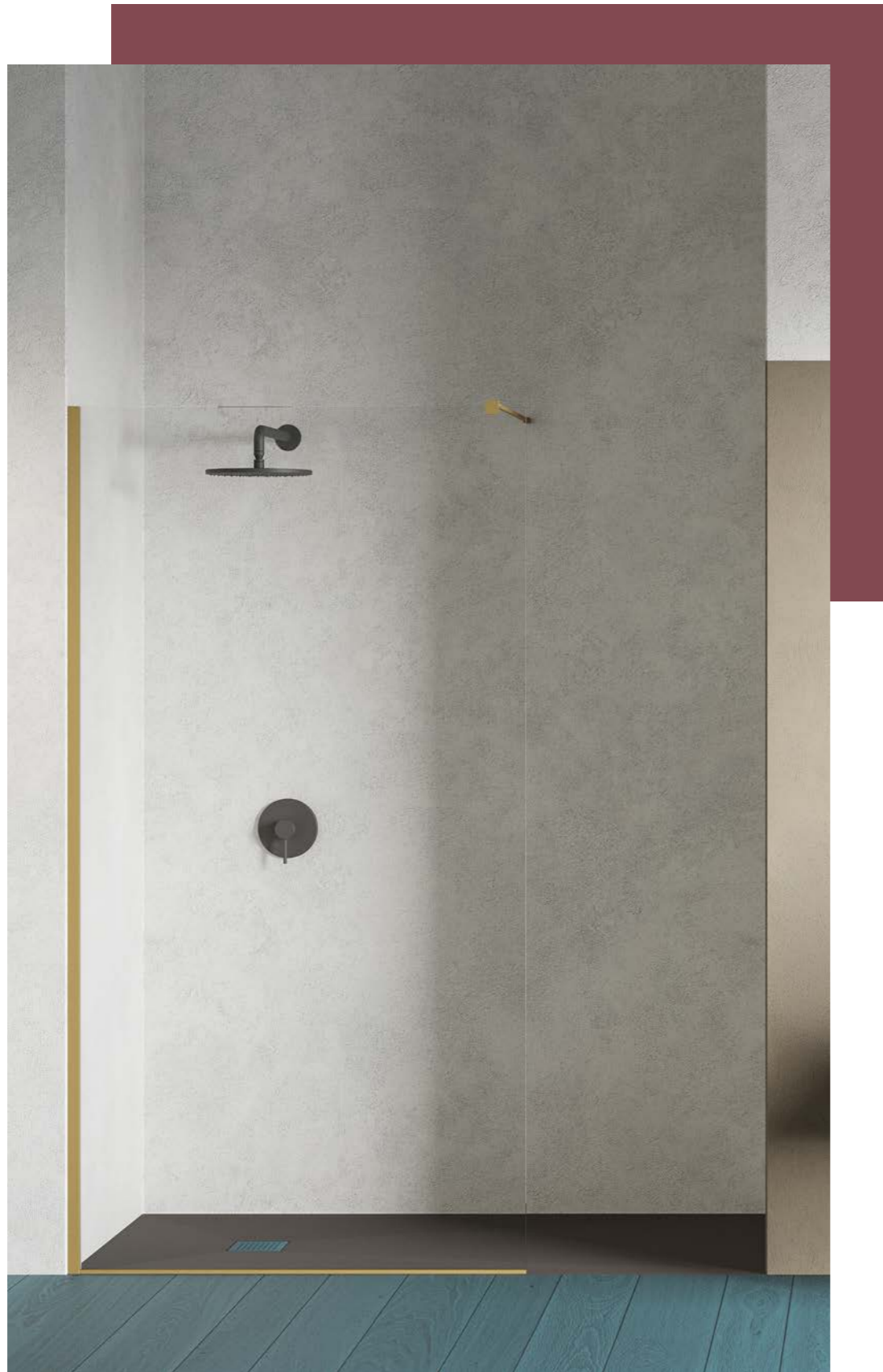

Walk-in installazione laterale  
profilo Amber / vetro Trasparente  
Piatto doccia ARTURO filo pavimento

Walk-in lateral installation  
Amber profile / Transparent glass  
level access shower tray ARTURO

## ITALO

Parete doccia walk-in versatile ed elegante con vetri di spessore 6/8/10 mm, supporti lineari e una variegata molteplicità di combinazioni. Creazioni dinamiche e libere che contano su montaggi facilitati grazie all'innovativo sistema di bloccaggio del vetro nel profilo a muro che agisce direttamente sul vetro compensando i fuori squadra e rendendo l'ingombro visivo minimo. L'appoggio a terra della lastra è dato da un profilo in alluminio quasi invisibile, un programma completo in cui fruizione e accesso risultano istantanei, la classe del made in Italy racchiuso nel più puro design minimal chic

A Versatile and elegant walk-in shower wall with a 6/8/10 mm glass, linear supports and many combinations available. The easy installation leave room to dynamic creations, thanks to the innovative glass locking system in the wall profile, which acts directly on the glass, compensating for out-of-squares and minimizing visual obstruction. The floor support of the glass panel is provided by an almost invisible aluminum profile, a comprehensive program where access is immediate, embodying the so-called Made in Italy style, embodied by the purest minimal chic design

**01** morsetto per fissaggio a soffitto | **02** | **02\_a** sistema di supporti abbinabili per combinazioni angolari | **03** cerniere per deflettore Bella con rotazione 170° (80°+90°) | **04** supporto di rinforzo fisso per L-6 | **05** profilo a terra in finitura

**01** ceiling fixing clamp | **02** | **02\_a** compatible supports for corner combinations | **03** Bella hinges 170° (80°+90°) | **04** opening and screws fixing for L-6 fixed support | **05** in ground profile with matching finish

## WALK-IN



01



02



02\_a



03



04



05



### CARATTERISTICHE FEATURES

- H cm** ALTEZZA PARETI DOCCIA 200/260  
SHOWER DOOR HEIGHT 200/260
- SP mm** SPESSORE LASTRA 6/8/10  
GLASS DEPTH 6/8/10
- REV** REVERSIBILE  
REVERSIBLE

### INFO TECNICHE TECHNICAL INFORMATION

- REGOLAZIONE FUORI SQUADRO**  
OFF-SQUARE REGULATION
- 1 cm** ESTENSIBILITÀ  
EXSTENSIBILITY
- NEVERDROP®** TRATTAMENTO NEVERDROP®  
NEVERDROP® TREATMENT
- L/H** MISURE SPECIALI  
SPECIAL SIZES
- DECOGRAFIA**  
DECOPRINTING

### Finiture profili

#### ORIGIN

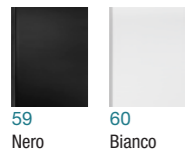

### Profiles finishing

#### ABITAT

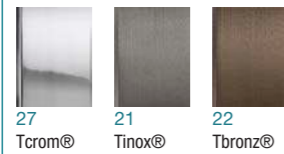

#### VOGUE

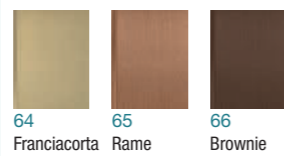
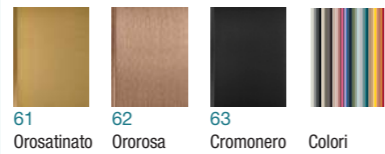

### Vetri

### Glasses



### installazioni previste allowed installations

#### in nicchia

IT-TO/260/6/8/10

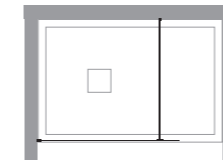

IT-6+B-6

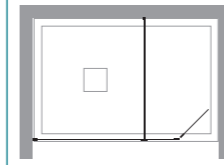

IT-8+B-6

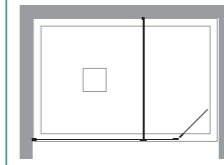

#### niche

#### ad angolo

IT-TO/260/6/8/10

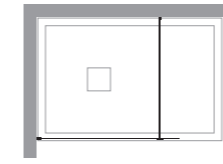

IT-6+B-6

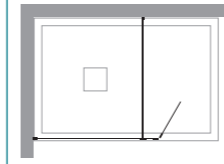

IT-8+B-6

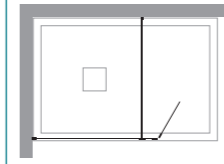

IT-6+L-6

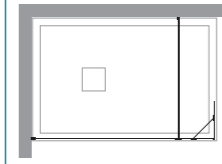

IT-6+IT-6

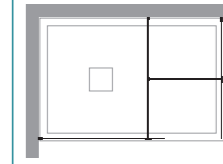

IT-8+IT-8

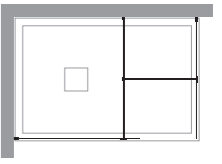

#### ad angolo

IT-260+IT-260

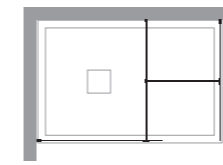

IT-10+IT-10

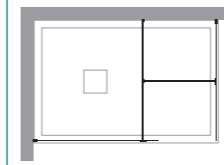

#### corner

IT-6+IT-6+B-6

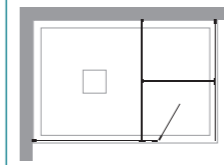

IT-8+IT-8+B-6

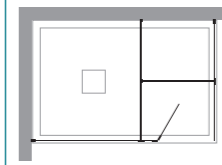

L-6+IT-6

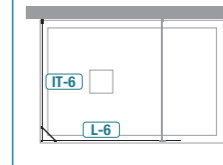

L-6+IT-6+IT-6

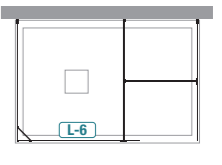

#### centrale

IT-C8/C10

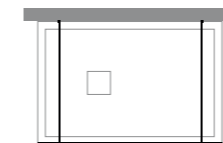

IT-C8+B-6

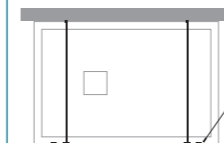

#### central

IT-C8+B-6+B-6

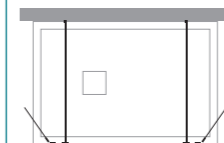

### profili

### profiles

per/for IT-6

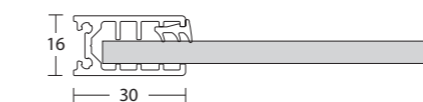

profilo a muro 1135 + guarnizione 78x10

wall profile 1135 + seal 78x10

per/for IT: 260-8-18-S8

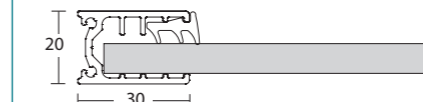

profilo a muro 1115 + guarnizione 78x14

wall profile 1115 + seal 78x14

per/for IT-10

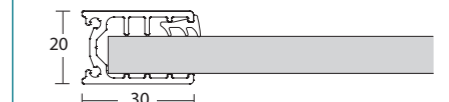

profilo a muro 1115 + guarnizione 78x10

wall profile 1115 + seal 78x10

### importante

### important

ordini per pareti doccia speciali senza relativo disegno  
NON vengono prodotti

orders for special shower walls without related design are  
NOT produced

per installazioni particolari richiedere fattibilità. Alcune  
configurazioni necessitano di elementi aggiuntivi

contact TDA technical office for particular installation. More  
elements could be needed

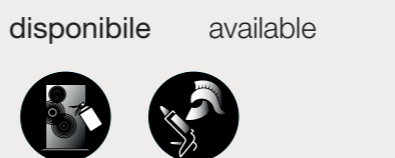
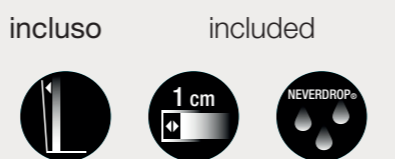
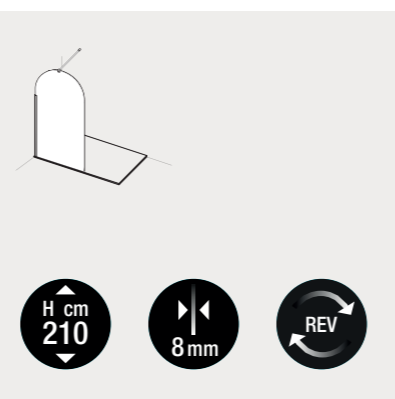

### installazioni

laterale side  
IT-TO

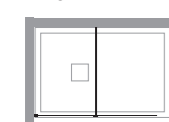

### informazioni

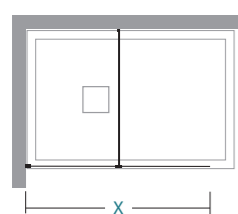

X lunghezza parete doccia\ shower wall length

### installations

### informations

| X       |   |      |  |  |  |  |  |  |  |
|---------|---|------|--|--|--|--|--|--|--|
| 98-99   | 1 | 47,8 |  |  |  |  |  |  |  |
| 118-119 | 1 | 57,8 |  |  |  |  |  |  |  |

### Misure standard

### Standard sizes

| Codice Code | estensibilità extension | Finiture profili Profiles finishing | 30 | 16 | 29 | 28 | 25 | 26 | 27 | 12 |
|-------------|-------------------------|-------------------------------------|----|----|----|----|----|----|----|----|
| 07W080100   | 98-99                   | origin<br>abitat<br>vogue           |    |    |    |    |    |    |    |    |
| 07W080120   | 118-119                 | origin<br>abitat<br>vogue           |    |    |    |    |    |    |    |    |

### attenzione

Con L.100 profilo H.160, con L.120 profilo H.150

With L.100 profile H.160, with L.120 profile H.150

### warning

Incluso: supporto di rinforzo regolabile e snodato con connettore a T

Included: adjustable, articulated supporting bar with T-connector

### Approfondimenti Insights



|  |     |
|--|-----|
| Indice Index                           | 3   |
| Legenda simboli Icons legend           | 11  |
| Profili - Vetri Profiles - Glasses     | 21  |
| Ricambi Spare parts                    | 406 |
| Profili speciali Special profiles      | 434 |
| Schede rilievo misure Measurement form | 444 |

### supplementi

Sigillante SPARTAN®  
Sealant SPARTAN®

36B010010

|                         |        |                   |       |      |      |                    |             |              |          |            |    |    |    |
|-------------------------|--------|-------------------|-------|------|------|--------------------|-------------|--------------|----------|------------|----|----|----|
| 05                      | 11     | 12                | 16    | 24   | 25   | 26                 | 27          | 28           | 29       | 30         | 31 | 32 | 34 |
| acrilico satin<br>flack | reflex | satinato<br>nigol | flute | wave | alon | fumè brown<br>fumè | trasparente | extrachiario | cincillà | stampato C |    |    |    |

|                     |                                    |  |
|---------------------|------------------------------------|--|
| origin              | abitat                             | vogue  |
| 59 Nero / 60 Bianco | 27 Tcrom® / 21 Tinox® / 22 Tbronz® | 61 Orosatinato / 62 Ororosa / 63 Cromonero / 64 Franciacorta / 65 Rame / 66 Brownie / Colori |

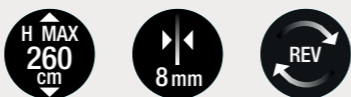
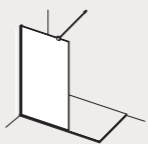

incluso included

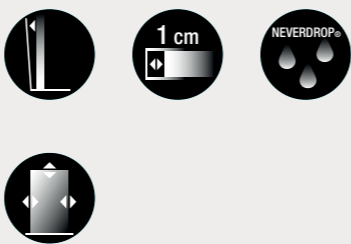

disponibile available



installazioni

laterale side  
IT-260

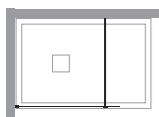

installations

ad angolo corner  
IT-260+IT-260

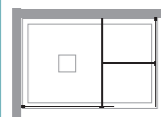

informazioni

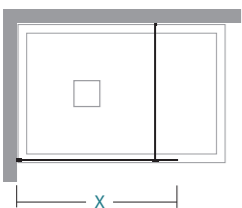

X lunghezza parete doccia\ shower wall length

informations

| X         |   |        |  |  |  |  |  |  |  |
|-----------|---|--------|--|--|--|--|--|--|--|
| 30 - 60   | 1 | max 42 |  |  |  |  |  |  |  |
| 61 - 80   | 1 | max 52 |  |  |  |  |  |  |  |
| 81 - 100  | 1 | max 62 |  |  |  |  |  |  |  |
| 101 - 120 | 1 | max 73 |  |  |  |  |  |  |  |
| 121 - 140 | 1 | max 83 |  |  |  |  |  |  |  |
| 141 - 160 | 1 | max 93 |  |  |  |  |  |  |  |

Misure speciali L / H Special sizes L / H

| Codice Code | su misura bespoke | Finiture profili Profiles finishing | 30 | 16 | 29 | 28 | 25 | 26 | 27 | 31 |
|-------------|-------------------|-------------------------------------|----|----|----|----|----|----|----|----|
| 07W059001   | 30 < L < 60       | origin<br>abitat<br>vogue           |    |    |    |    |    |    |    |    |
| 07W059001   | 61 < L < 80       | origin<br>abitat<br>vogue           |    |    |    |    |    |    |    |    |
| 07W059001   | 81 < L < 100      | origin<br>abitat<br>vogue           |    |    |    |    |    |    |    |    |
| 07W059001   | 101 < L < 120     | origin<br>abitat<br>vogue           |    |    |    |    |    |    |    |    |
| 07W059001   | 121 < L < 140     | origin<br>abitat<br>vogue           |    |    |    |    |    |    |    |    |
| 07W059001   | 141 < L < 160     | origin<br>abitat<br>vogue           |    |    |    |    |    |    |    |    |

attenzione

Il prezzo della H speciale va trovato nella tabella Misure speciali L / H in base alla L della parete doccia

Special price for H is to be found in Special sizes L / H as per L needed size

warning

NON abbinabile a Bella B-6 e Leo L-6

NOT to match Bella B-6 and Leo L-6

Incluso: supporto di rinforzo regolabile e snodato con connettore a T

Included: adjustable, articulated supporting bar with T-connector

Per H oltre 220 cm, addebito di 220 € netti a collo per imballo protettivo

For items above 220 cm in H, a surcharge of € 220 net will be charged for each individual protective packaging

Approfondimenti Insights



|  |     |
|--|-----|
| Indice Index                           | 3   |
| Legenda simboli Icons legend           | 11  |
| Profili - Vetri Profiles - Glasses     | 21  |
| Ricambi Spare parts                    | 406 |
| Profili speciali Special profiles      | 434 |
| Schede rilievo misure Measurement form | 444 |

Misure speciali Special size

|       |        |
|-------|--------|
| H max | 260 cm |
| L min | 30 cm  |
| L max | 160 cm |

supplementi

Morsetto a soffitto Cellin clamp

36S100001 €

supplements

Sigillante SPARTAN® Sealant SPARTAN®

36B010010 €

|                |       |        |          |       |       |      |      |            |      |             |              |          |            |
|----------------|-------|--------|----------|-------|-------|------|------|------------|------|-------------|--------------|----------|------------|
| 05             | 11    | 12     | 16       | 24    | 25    | 26   | 27   | 28         | 29   | 30          | 31           | 32       | 34         |
| acrilico satin | flack | reflex | satinato | nigol | flute | wave | aion | fumè brown | fumè | trasparente | extrachiario | cincillà | stampato C |

|                     |                                    |  |
|---------------------|------------------------------------|--|
| origin              | abitat                             | vogue  |
| 59 Nero / 60 Bianco | 27 Tcrom® / 21 Tinox® / 22 Tbronz® | 61 Orosatinato / 62 Ororosa / 63 Cromonero / 64 Franciacorta / 65 Rame / 66 Brownie / Colori |

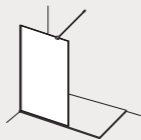

incluso

included



disponibile

available



### installazioni

laterale side  
IT-6

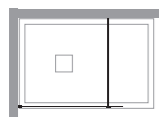

### installations

laterale side  
IT-6+B-6

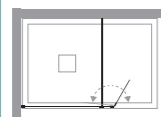

laterale side  
IT-6+L-6

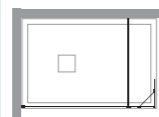

ad angolo corner  
IT-6+IT-6

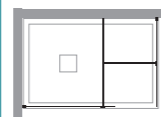

ad angolo corner  
IT-6+IT-6+B-6



### informazioni

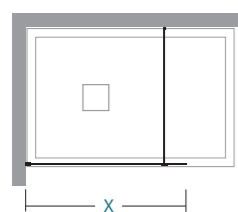

walk-in  
walk-in

### informations

| X     | nr | Kg max | X       | nr | Kg max |
|-------|----|--------|---------|----|--------|
| 28-29 | 1  | 12     | 88-89   | 1  | 32     |
| 38-39 | 1  | 16     | 98-99   | 1  | 35     |
| 48-49 | 1  | 19     | 108-109 | 1  | 39     |
| 58-59 | 1  | 22     | 118-119 | 1  | 42     |
| 68-69 | 1  | 25     | 138-139 | 1  | 49     |
| 78-79 | 1  | 29     | 158-159 | 1  | 55     |

X lunghezza parete doccia\ shower wall length

### Misure standard

### Standard sizes

| Codice Code | estensibilità extension | Finiture profili Profiles finishing | 30 | 16 | 29 | 28 | 31 | 12 | 11 |
|-------------|-------------------------|-------------------------------------|----|----|----|----|----|----|----|
| 07F090030   | 28-29                   | origin<br>abiat<br>vogue            |    |    |    |    |    |    |    |
| 07F090040   | 38-39                   | origin<br>abiat<br>vogue            |    |    |    |    |    |    |    |
| 07F090050   | 48-49                   | origin<br>abiat<br>vogue            | ■  |    |    |    |    |    |    |
| 07F090060   | 58-59                   | origin<br>abiat<br>vogue            | ■  |    |    |    |    |    |    |
| 07F090070   | 68-69                   | origin<br>abiat<br>vogue            | ■  |    |    |    |    |    |    |
| 07F090080   | 78-79                   | origin<br>abiat<br>vogue            | ■  |    |    |    |    |    |    |
| 07F090090   | 88-89                   | origin<br>abiat<br>vogue            | ■  |    |    |    |    |    |    |
| 07F090100   | 98-99                   | origin<br>abiat<br>vogue            | ■  |    |    |    |    |    |    |
| 07F090110   | 108-109                 | origin<br>abiat<br>vogue            | ■  |    |    |    |    |    |    |
| 07F090120   | 118-119                 | origin<br>abiat<br>vogue            | ■  |    |    |    |    |    |    |
| 07F090140   | 138-139                 | origin<br>abiat<br>vogue            | ■  |    |    |    |    |    |    |
| 07F090160   | 158-159                 | origin<br>abiat<br>vogue            | ■  |    |    |    |    |    |    |

| 05                  | 11    | 12     | 16                                 | 24    | 25    | 26   | 27   | 28         | 29   | 30          | 31           | 32       | 34         |
|---------------------|-------|--------|------------------------------------|-------|-------|------|--|------------|------|-------------|--------------|----------|------------|
| acrilico satin      | flack | reflex | satinato                           | nigol | flute | wave | alon   | fumè brown | fumè | trasparente | extrachiario | cincillà | stampato C |
| origin              |       |        | abiat                              |       |       |      | vogue  |            |      |             |              |          |            |
| 59 Nero / 60 Bianco |       |        | 27 Tcrom® / 21 Tinox® / 22 Tbronz® |       |       |      | 61 Orosatinato / 62 Ororosa / 63 Cromonero / 64 Franciacorta / 65 Rame / 66 Brownie / Colori |            |      |             |              |          |            |

**Misure speciali L / H**
**Special sizes L / H**

| Codice<br>Code | su misura<br>bespoke | Finiture profili<br>Profiles finishing | 30 | 16 | 29 | 28 | 24 | 25 | 26 | 27 | 31 | 12 |
|----------------|----------------------|--|----|----|----|----|----|----|----|----|----|----|
| 07F099001      | L < 30               | origin<br>abibat<br>vogue              |    |    |    |    |    |    |    |    |    |    |
| 07F099001      | 31 < L < 60          | origin<br>abibat<br>vogue              |    |    |    |    |    |    |    |    |    |    |
| 07F099001      | 61 < L < 100         | origin<br>abibat<br>vogue              |    |    |    |    |    |    |    |    |    |    |
| 07F099001      | 101 < L < 140        | origin<br>abibat<br>vogue              |    |    |    |    |    |    |    |    |    |    |
| 07F099001      | 141 < L < 160        | origin<br>abibat<br>vogue              |    |    |    |    |    |    |    |    |    |    |
| 07F099001      | 161 < L < 180        | origin<br>abibat<br>vogue              |    |    |    |    |    |    |    |    |    |    |

**attenzione**

Il prezzo della **H** speciale va trovato nella tabella **Misure speciali L / H** in base alla **L** della parete doccia

Special price for **H** is to be found in **Special sizes L / H** as per **L** needed size

**warning**

Optical e Terra - decografia per: vetro Trasparente e Fumè, max L 135 cm

Optical and Terra - decoprinting for: glass Trasparente and Fumè, max L 135 cm

Abbinabile a Bella **B-6** e Leo **L-6**

To match Bella **B-6** and Leo **L-6**

Incluso: supporto di rinforzo regolabile e snodato con connettore a T

Included: adjustable, articulated supporting bar with T-connector

Approfondimenti  
Insights



Indice  
Index 3

Legenda simboli  
Icons legend 11

Profili - Vetri  
Profiles - Glasses 21

Ricambi  
Spare parts 406

Profili speciali  
Special profiles 434

Schede rilievo misure  
Measurement form 444

Misure speciali  
Special size

Disponibilità  
Availability

**H** max 210 cm  
**L** max 180 cm

■ STOCK Tcrom®  
■ STOCK Tcrom®+Tinox®

**supplementi**
**supplements**

Decografia  
Decoprinting

Sigillante SPARTAN®  
Sealant SPARTAN®

per codice  
for code

€ 36B010010 €

05 11 12 16 24 25 26 27 28 29 30 31 32 34  
 acrilico satin flack reflex satinato nigol flute wave aion fumè brown fumè trasparente extrachiaro cincillà stampato C

origin abibat vogue  
 59 Nero / 60 Bianco 27 Tcrom® / 21 Tinox® / 22 Tbronze® 61 Orosatinato / 62 Ororosa / 63 Cromonero / 64 Franciacorta / 65 Rame / 66 Brownie / Colori

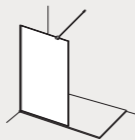

incluso

included



disponibile

available



installazioni

laterale side  
IT-8

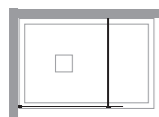

installations

laterale side  
IT-8+B-6

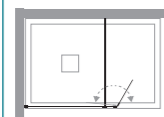

ad angolo corner  
IT-8+IT-8

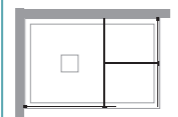

ad angolo corner  
IT-8+IT-8+B-6

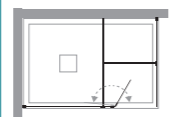

informazioni

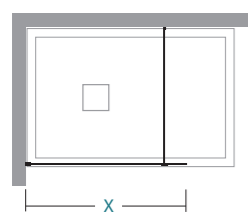

walk-in  
walk-in

informations

| X     | nr | Kg max | X       | nr | Kg max |
|-------|----|--------|---------|----|--------|
| 28-29 | 1  | 15     | 88-89   | 1  | 41     |
| 38-39 | 1  | 19     | 98-99   | 1  | 45     |
| 48-49 | 1  | 24     | 108-109 | 1  | 50     |
| 58-59 | 1  | 28     | 118-119 | 1  | 54     |
| 68-69 | 1  | 32     | 138-139 | 1  | 63     |
| 78-79 | 1  | 37     | 158-159 | 1  | 71     |

X lunghezza parete doccia\ shower wall length

Misure standard

Standard sizes

| Codice Code | estensibilità extension | Finiture profili Profiles finishing | 30 | 16 | 29 | 28 | 31 | 12 | 11 |
|-------------|-------------------------|-------------------------------------|----|----|----|----|----|----|----|
| 07F070030   | 28-29                   | origin                              |    |    |    |    |    |    |    |
|             |                         | abitat                              |    |    |    |    |    |    |    |
|             |                         | vogue                               |    |    |    |    |    |    |    |
| 07F070040   | 38-39                   | origin                              |    |    |    |    |    |    |    |
|             |                         | abitat                              |    |    |    |    |    |    |    |
|             |                         | vogue                               |    |    |    |    |    |    |    |
| 07F070050   | 48-49                   | origin                              |    |    |    |    |    |    |    |
|             |                         | abitat                              |    |    |    |    |    |    |    |
|             |                         | vogue                               |    |    |    |    |    |    |    |
| 07F070060   | 58-59                   | origin                              |    |    |    |    |    |    |    |
|             |                         | abitat                              |    |    |    |    |    |    |    |
|             |                         | vogue                               |    |    |    |    |    |    |    |
| 07F070070   | 68-69                   | origin                              |    |    |    |    |    |    |    |
|             |                         | abitat                              |    |    |    |    |    |    |    |
|             |                         | vogue                               |    |    |    |    |    |    |    |
| 07F070080   | 78-79                   | origin                              |    |    |    |    |    |    |    |
|             |                         | abitat                              |    |    |    |    |    |    |    |
|             |                         | vogue                               |    |    |    |    |    |    |    |
| 07F070090   | 88-89                   | origin                              |    |    |    |    |    |    |    |
|             |                         | abitat                              |    |    |    |    |    |    |    |
|             |                         | vogue                               |    |    |    |    |    |    |    |
| 07F070100   | 98-99                   | origin                              |    |    |    |    |    |    |    |
|             |                         | abitat                              |    |    |    |    |    |    |    |
|             |                         | vogue                               |    |    |    |    |    |    |    |
| 07F070110   | 108-109                 | origin                              |    |    |    |    |    |    |    |
|             |                         | abitat                              |    |    |    |    |    |    |    |
|             |                         | vogue                               |    |    |    |    |    |    |    |
| 07F070120   | 118-119                 | origin                              |    |    |    |    |    |    |    |
|             |                         | abitat                              |    |    |    |    |    |    |    |
|             |                         | vogue                               |    |    |    |    |    |    |    |
| 07F070140   | 138-139                 | origin                              |    |    |    |    |    |    |    |
|             |                         | abitat                              |    |    |    |    |    |    |    |
|             |                         | vogue                               |    |    |    |    |    |    |    |
| 07F070160   | 158-159                 | origin                              |    |    |    |    |    |    |    |
|             |                         | abitat                              |    |    |    |    |    |    |    |
|             |                         | vogue                               |    |    |    |    |    |    |    |

| 05                  | 11    | 12     | 16                                 | 24    | 25    | 26   | 27   | 28         | 29   | 30          | 31           | 32       | 34         |
|---------------------|-------|--------|------------------------------------|-------|-------|------|--|------------|------|-------------|--------------|----------|------------|
| acrilico satin      | flack | reflex | satinato                           | nigol | flute | wave | alon   | fumè brown | fumè | trasparente | extrachiario | cincillà | stampato C |
| origin              |       |        | abitat                             |       |       |      | vogue  |            |      |             |              |          |            |
| 59 Nero / 60 Bianco |       |        | 27 Tcrom® / 21 Tinox® / 22 Tbronz® |       |       |      | 61 Orosatinato / 62 Ororosa / 63 Cromonero / 64 Franciacorta / 65 Rame / 66 Brownie / Colori |            |      |             |              |          |            |

**Misure speciali L / H**
**Special sizes L / H**

| Codice<br>Code | su misura<br>bespoke | Finiture profili<br>Profiles finishing | 30 | 16 | 29 | 28 | 24 | 25 | 26 | 27 | 31 | 12 |
|----------------|----------------------|--|----|----|----|----|----|----|----|----|----|----|
| 07F079001      | L < 30               | origin<br>abitat<br>vogue              |    |    |    |    |    |    |    |    |    |    |
| 07F079001      | 31 < L < 60          | origin<br>abitat<br>vogue              |    |    |    |    |    |    |    |    |    |    |
| 07F079001      | 61 < L < 100         | origin<br>abitat<br>vogue              |    |    |    |    |    |    |    |    |    |    |
| 07F079001      | 101 < L < 140        | origin<br>abitat<br>vogue              |    |    |    |    |    |    |    |    |    |    |
| 07F079001      | 141 < L < 160        | origin<br>abitat<br>vogue              |    |    |    |    |    |    |    |    |    |    |
| 07F079001      | 161 < L < 180        | origin<br>abitat<br>vogue              |    |    |    |    |    |    |    |    |    |    |

**attenzione**

Il prezzo della **H** speciale va trovato nella tabella **Misure speciali L / H** in base alla **L** della parete doccia

Special price for **H** is to be found in **Special sizes L / H** as per **L** needed size

**warning**

Optical e Terra - decografia per: vetro Trasparente e Fumè, max L 135 cm

Optical and Terra - decoprinting for: glass Trasparente and Fumè, max L 135 cm

Abbinabile a Bella **B-6**; **NON** abbinabile a Leo **L-6**

To match Bella **B-6** NOT Leo **L-6**

Incluso: supporto di rinforzo regolabile e snodato con connettore a T

Included: adjustable, articulated supporting bar with T-connector

Approfondimenti  
Insights



Indice  
Index 3

Legenda simboli  
Icons legend 11

Profili - Vetri  
Profiles - Glasses 21

Ricambi  
Spare parts 406

Profili speciali  
Special profiles 434

Schede rilievo misure  
Measurement form 444

Misure speciali  
Special size

Disponibilità  
Availability

**H** max 210 cm  
**L** max 180 cm

■ STOCK Nero  
■ STOCK Tcrom®  
■ STOCK Tcrom®+Tinox®

**supplementi**
**supplements**

Decografia  
Decoprinting

Sigillante SPARTAN®  
Sealant SPARTAN®

per codice  
for code

€ 36B010010 €

05 11 12 16 24 25 26 27 28 29 30 31 32 34  
 acrilico satin flack reflex satinato nigol flute wave aion fumè brown fumè trasparente extrachiaro cincillà stampato C

origin abitat vogue  
 59 Nero / 60 Bianco 27 Tcrom® / 21 Tinox® / 22 Tbronze® 61 Orosatinato / 62 Ororosa / 63 Cromonero / 64 Franciacorta / 65 Rame / 66 Brownie / Colori

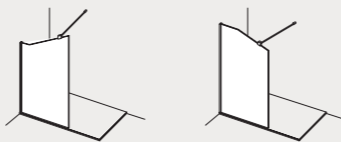

esempio  
example

esempio  
example



incluso

included

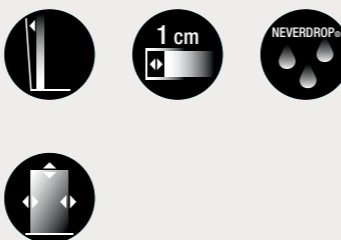

disponibile

available



installazioni

laterale side

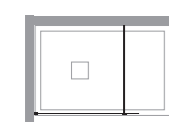

informazioni

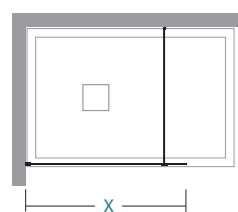

X lunghezza parete doccia\ shower wall length

installations

informations

| X         |   |        |  |  |  |  |  |  |  |
|-----------|---|--------|--|--|--|--|--|--|--|
| 30 - 60   | 1 | max 32 |  |  |  |  |  |  |  |
| 61 - 80   | 1 | max 40 |  |  |  |  |  |  |  |
| 81 - 100  | 1 | max 49 |  |  |  |  |  |  |  |
| 101 - 120 | 1 | max 57 |  |  |  |  |  |  |  |
| 121 - 140 | 1 | max 66 |  |  |  |  |  |  |  |
| 141 - 160 | 1 | max 74 |  |  |  |  |  |  |  |
| 161 - 180 | 1 | max 83 |  |  |  |  |  |  |  |

Misure speciali L / H Special sizes L / H

| Codice Code | su misura bespoke | Finiture profili Profiles finishing | 30 | 16 | 29 | 28 | 25 | 26 | 27 | 31 |
|-------------|-------------------|-------------------------------------|----|----|----|----|----|----|----|----|
| 07W069001   | 30 < L < 60       | origin<br>abitat<br>vogue           |    |    |    |    |    |    |    |    |
| 07W069001   | 61 < L < 80       | origin<br>abitat<br>vogue           |    |    |    |    |    |    |    |    |
| 07W069001   | 81 < L < 100      | origin<br>abitat<br>vogue           |    |    |    |    |    |    |    |    |
| 07W069001   | 101 < L < 120     | origin<br>abitat<br>vogue           |    |    |    |    |    |    |    |    |
| 07W069001   | 121 < L < 140     | origin<br>abitat<br>vogue           |    |    |    |    |    |    |    |    |
| 07W069001   | 141 < L < 160     | origin<br>abitat<br>vogue           |    |    |    |    |    |    |    |    |
| 07W069001   | 161 < L < 180     | origin<br>abitat<br>vogue           |    |    |    |    |    |    |    |    |

attenzione

Il prezzo della H speciale va trovato nella tabella Misure speciali L / H in base alla L della parete doccia

Special price for H is to be found in Special sizes L / H as per L needed size

warning

Incluso: supporto di rinforzo regolabile e snodato con connettore a T

Included: adjustable, articulated supporting bar with T-connector

Ordini per pareti doccia speciali senza relativo disegno NON vengono prodotti

Orders for special shower walls without related design are NOT produced

Misure speciali  
Special size

|   |     |        |
|---|-----|--------|
| H | max | 210 cm |
| L | min | 30 cm  |
| L | max | 180 cm |

supplementi

Sigillante SPARTAN®  
Sealant SPARTAN®

€

36B010010

supplements

|                |       |        |          |       |       |      |      |            |      |             |              |          |            |
|----------------|-------|--------|----------|-------|-------|------|------|------------|------|-------------|--------------|----------|------------|
| 05             | 11    | 12     | 16       | 24    | 25    | 26   | 27   | 28         | 29   | 30          | 31           | 32       | 34         |
| acrilico satin | flack | reflex | satinato | nigol | flute | wave | alon | fumè brown | fumè | trasparente | extrachiario | cincillà | stampato C |

|                     |                                    |  |  |  |  |  |  |  |  |  |  |  |  |
|---------------------|------------------------------------|--|--|--|--|--|--|--|--|--|--|--|--|
| origin              | abitat                             | vogue  |  |  |  |  |  |  |  |  |  |  |  |
| 59 Nero / 60 Bianco | 27 Tcrom® / 21 Tinox® / 22 Tbronz® | 61 Orosatinato / 62 Ororosa / 63 Cromonero / 64 Franciacorta / 65 Rame / 66 Brownie / Colori |  |  |  |  |  |  |  |  |  |  |  |

Approfondimenti  
Insights



|   |     |
|---|-----|
| Indice<br>Index                           | 3   |
| Legenda simboli<br>Icons legend           | 11  |
| Profili - Vetri<br>Profiles - Glasses     | 21  |
| Ricambi<br>Spare parts                    | 406 |
| Profili speciali<br>Special profiles      | 434 |
| Schede rilievo misure<br>Measurement form | 444 |

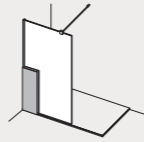

esempio  
example



incluso

included



disponibile

available



installazioni

laterale side  
IT-S8

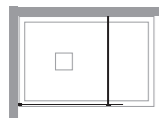

informazioni

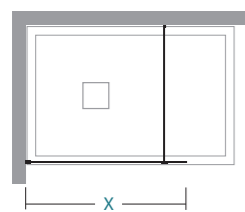

X lunghezza parete doccia\ shower wall length

installations

informations

| X         |   |        |  |  |  |  |  |  |  |
|-----------|---|--------|--|--|--|--|--|--|--|
| 30 - 60   | 1 | max 32 |  |  |  |  |  |  |  |
| 61 - 80   | 1 | max 40 |  |  |  |  |  |  |  |
| 81 - 100  | 1 | max 49 |  |  |  |  |  |  |  |
| 101 - 120 | 1 | max 57 |  |  |  |  |  |  |  |
| 121 - 140 | 1 | max 66 |  |  |  |  |  |  |  |
| 141 - 160 | 1 | max 74 |  |  |  |  |  |  |  |
| 161 - 180 | 1 | max 83 |  |  |  |  |  |  |  |

Misure speciali L / H Special sizes L / H

| Codice Code | su misura bespoke | Finiture profili Profiles finishing | 30 | 16 | 29 | 28 | 25 | 26 | 27 | 31 |
|-------------|-------------------|-------------------------------------|----|----|----|----|----|----|----|----|
| 07W079001   | 30 < L < 60       | origin<br>abitat<br>vogue           |    |    |    |    |    |    |    |    |
| 07W079001   | 61 < L < 80       | origin<br>abitat<br>vogue           |    |    |    |    |    |    |    |    |
| 07W079001   | 81 < L < 100      | origin<br>abitat<br>vogue           |    |    |    |    |    |    |    |    |
| 07W079001   | 101 < L < 120     | origin<br>abitat<br>vogue           |    |    |    |    |    |    |    |    |
| 07W079001   | 121 < L < 140     | origin<br>abitat<br>vogue           |    |    |    |    |    |    |    |    |
| 07W079001   | 141 < L < 160     | origin<br>abitat<br>vogue           |    |    |    |    |    |    |    |    |
| 07W079001   | 161 < L < 180     | origin<br>abitat<br>vogue           |    |    |    |    |    |    |    |    |

attenzione

Il prezzo della H speciale va trovato nella tabella Misure speciali L / H in base alla L della parete doccia

Special price for H is to be found in Special sizes L / H as per L needed size

warning

Incluso: supporto di rinforzo regolabile e snodato con connettore a T

Included: adjustable, articulated supporting bar with T-connector

Ordini per pareti doccia speciali senza relativo disegno NON vengono prodotti

Orders for special shower walls without related design are NOT produced

Misure speciali  
Special size

|   |     |        |
|---|-----|--------|
| H | max | 210 cm |
| L | min | 30 cm  |
| L | max | 180 cm |

supplementi

Sigillante SPARTAN®  
Sealant SPARTAN®

€

36B010010

supplements

|                |       |        |          |       |       |      |      |            |      |             |              |          |            |
|----------------|-------|--------|----------|-------|-------|------|------|------------|------|-------------|--------------|----------|------------|
| 05             | 11    | 12     | 16       | 24    | 25    | 26   | 27   | 28         | 29   | 30          | 31           | 32       | 34         |
| acrilico satin | flack | reflex | satinato | nigol | flute | wave | alon | fumè brown | fumè | trasparente | extrachiario | cincillà | stampato C |

|                     |                                    |  |
|---------------------|------------------------------------|--|
| origin              | abitat                             | vogue  |
| 59 Nero / 60 Bianco | 27 Tcrom® / 21 Tinox® / 22 Tbronz® | 61 Orosatinato / 62 Ororosa / 63 Cromonero / 64 Franciacorta / 65 Rame / 66 Brownie / Colori |

Approfondimenti  
Insights



|   |     |
|---|-----|
| Indice<br>Index                           | 3   |
| Legenda simboli<br>Icons legend           | 11  |
| Profili - Vetri<br>Profiles - Glasses     | 21  |
| Ricambi<br>Spare parts                    | 406 |
| Profili speciali<br>Special profiles      | 434 |
| Schede rilievo misure<br>Measurement form | 444 |

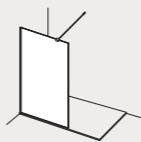

incluso

included



disponibile

available

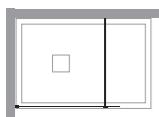

## installazioni

laterale side  
IT-10

## installations

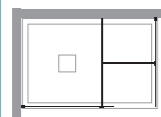
ad angolo corner  
IT-10+IT-10

## informazioni

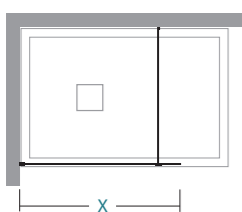
walk-in  
walk-in

## informations

| X     | nr | Kg max | X       | nr | Kg max |
|-------|----|--------|---------|----|--------|
| 28-29 | 1  | 18     | 88-89   | 1  | 50     |
| 38-39 | 1  | 23     | 98-99   | 1  | 55     |
| 48-49 | 1  | 29     | 108-109 | 1  | 61     |
| 58-59 | 1  | 34     | 118-119 | 1  | 66     |
| 68-69 | 1  | 39     | 138-139 | 1  | 77     |
| 78-79 | 1  | 45     | 158-159 | 1  | 87     |

X lunghezza parete doccia\ shower wall length

## Misure standard

## Standard sizes

| Codice Code | estensibilità extension | Finiture profili Profiles finishing | 30 | 29 | 28 | 11 |
|-------------|-------------------------|-------------------------------------|----|----|----|----|
| 07W010030   | 28-29                   | origin<br>abibat<br>vogue           |    |    |    |    |
| 07W010040   | 38-39                   | origin<br>abibat<br>vogue           |    |    |    |    |
| 07W010050   | 48-49                   | origin<br>abibat<br>vogue           |    |    |    |    |
| 07W010060   | 58-59                   | origin<br>abibat<br>vogue           |    |    |    |    |
| 07W010070   | 68-69                   | origin<br>abibat<br>vogue           |    |    |    |    |
| 07W010080   | 78-79                   | origin<br>abibat<br>vogue           |    |    |    |    |
| 07W010090   | 88-89                   | origin<br>abibat<br>vogue           |    |    |    |    |
| 07W010100   | 98-99                   | origin<br>abibat<br>vogue           |    |    |    |    |
| 07W010110   | 108-109                 | origin<br>abibat<br>vogue           |    |    |    |    |
| 07W010120   | 118-119                 | origin<br>abibat<br>vogue           |    |    |    |    |
| 07W010140   | 138-139                 | origin<br>abibat<br>vogue           |    |    |    |    |
| 07W010160   | 158-159                 | origin<br>abibat<br>vogue           |    |    |    |    |

05 acrilico satin 11 flack 12 reflex 16 satinato 24 nigol 25 flute 26 wave 27 alon 28 fumè brown 29 fumè 30 trasparente 31 extrachiaro 32 cincillà 34 stampato C

origin abibat vogue  
59 Nero / 60 Bianco 27 Tcrom® / 21 Tinox® / 22 Tbronz® 61 Orosatinato / 62 Ororosa / 63 Cromonero / 64 Franciacorta / 65 Rame / 66 Brownie / Colori

**Misure speciali L / H** Special sizes L / H

| Codice<br>Code | su misura<br>bespoke | Finiture profili<br>Profiles finishing | 30 | 29 | 28 |
|----------------|----------------------|--|----|----|----|
| 07W019001      | L < 30               | origin                                 |    |    |    |
|                |                      | abitat                                 |    |    |    |
|                |                      | vogue                                  |    |    |    |
| 07W019001      | 31 < L < 60          | origin                                 |    |    |    |
|                |                      | abitat                                 |    |    |    |
|                |                      | vogue                                  |    |    |    |
| 07W019001      | 61 < L < 100         | origin                                 |    |    |    |
|                |                      | abitat                                 |    |    |    |
|                |                      | vogue                                  |    |    |    |
| 07W019001      | 101 < L < 140        | origin                                 |    |    |    |
|                |                      | abitat                                 |    |    |    |
|                |                      | vogue                                  |    |    |    |
| 07W019001      | 141 < L < 160        | origin                                 |    |    |    |
|                |                      | abitat                                 |    |    |    |
|                |                      | vogue                                  |    |    |    |
| 07W019001      | 161 < L < 180        | origin                                 |    |    |    |
|                |                      | abitat                                 |    |    |    |
|                |                      | vogue                                  |    |    |    |

**attenzione**

Il prezzo della **H** speciale va trovato nella tabella **Misure speciali L / H** in base alla **L** della parete doccia

Special price for **H** is to be found in **Special sizes L / H** as per **L** needed size

Misure speciali  
Special size

**H** max 210 cm  
**L** max 180 cm

**supplementi**

Decografia  
Decoprinting

per codice  
for code

05 11 12 16 24 25 26 27 28 29 30 31 32 34  
 acrilico satin flack reflex satinato nigol flute wave aion fumè brown fumè trasparente extrachiaro cincillà stampato C

origin abitat vogue  
 59 Nero / 60 Bianco 27 Tcrom® / 21 Tinox® / 22 Tbronz® 61 Orosatinato / 62 Ororosa / 63 Cromonero / 64 Franciacorta / 65 Rame / 66 Brownie / Colori

**warning**

Optical e Terra - decografia per: vetro Trasparente e Fumè, max L 135 cm

Optical and Terra - decoprinting for: glass Trasparente and Fumè, max L 135 cm

**NON** abbinabile a Bella B-6 e Leo L-6

NOT to match Bella B-6 and Leo L-6

Incluso: supporto di rinforzo regolabile e snodato con connettore a T

Included: adjustable, articulated supporting bar with T-connector

Approfondimenti  
Insights



Indice  
Index 3

Legenda simboli  
Icons legend 11

Profili - Vetri  
Profiles - Glasses 21

Ricambi  
Spare parts 406

Profili speciali  
Special profiles 434

Schede rilievo misure  
Measurement form 444



**H cm 200**  
**8 mm**  
**REV**

incluso      included  
  
 disponibile      available

installazioni

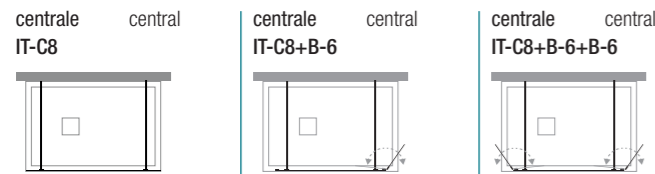

informazioni

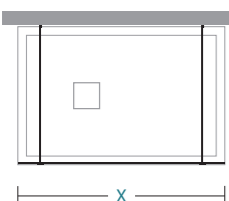

X lunghezza parete doccia \ shower wall length

installations

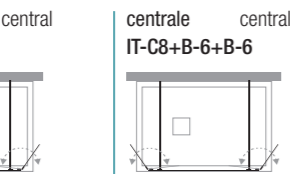

informations

| X     |  |  |  |  |  |  |  |  |  |   |    |
|-------|--|--|--|--|--|--|--|--|--|---|----|
| 87,3  |  |  |  |  |  |  |  |  |  | 1 | 40 |
| 97,3  |  |  |  |  |  |  |  |  |  | 1 | 45 |
| 117,3 |  |  |  |  |  |  |  |  |  | 1 | 53 |
| 137,3 |  |  |  |  |  |  |  |  |  | 1 | 62 |

Misure standard

| Codice Code | lunghezza lenght | Finiture profili Profiles finishing | 30 | 16 | 29 | 28 | 31 | 12 | 11 |
|-------------|------------------|-------------------------------------|----|----|----|----|----|----|----|
| 07F080090   | 87,3             | origin<br>abitat<br>vogue           |    |    |    |    |    |    |    |
| 07F080100   | 97,3             | origin<br>abitat<br>vogue           |    |    |    |    |    |    |    |
| 07F080120   | 117,3            | origin<br>abitat<br>vogue           |    |    |    |    |    |    |    |
| 07F080140   | 137,3            | origin<br>abitat<br>vogue           |    |    |    |    |    |    |    |

Misure speciali L / H

| Codice Code | su misura bespoke | Finiture profili Profiles finishing | 30 | 16 | 29 | 28 | 24 | 25 | 26 | 27 | 31 | 12 |
|-------------|-------------------|-------------------------------------|----|----|----|----|----|----|----|----|----|----|
| 07F089001   | 30 < L < 60       | origin<br>abitat<br>vogue           |    |    |    |    |    |    |    |    |    |    |
| 07F089001   | 61 < L < 100      | origin<br>abitat<br>vogue           |    |    |    |    |    |    |    |    |    |    |
| 07F089001   | 101 < L < 140     | origin<br>abitat<br>vogue           |    |    |    |    |    |    |    |    |    |    |
| 07F089001   | 141 < L < 160     | origin<br>abitat<br>vogue           |    |    |    |    |    |    |    |    |    |    |
| 07F089001   | 161 < L < 180     | origin<br>abitat<br>vogue           |    |    |    |    |    |    |    |    |    |    |

attenzione

Il prezzo della H speciale va trovato nella tabella Misure speciali L / H in base alla L della parete doccia

Special price for H is to be found in Special sizes L / H as per L needed size

warning

Optical e Terra - decografia per: vetro Trasparente e Fumè, max L 135 cm

Optical and Terra - decoprinting for: glass Trasparente and Fumè, max L 135 cm

Abbinabile a Bella B-6; NON abbinabile a Leo L-6

To match BellaB-6 NOT Leo L-6

Incluso: doppio supporto di rinforzo regolabile e snodato

Included: double adjustable, articulated supporting bar

Approfondimenti Insights



|  |     |
|--|-----|
| Indice Index                           | 3   |
| Legenda simboli Icons legend           | 11  |
| Profili - Vetri Profiles - Glasses     | 21  |
| Ricambi Spare parts                    | 406 |
| Profili speciali Special profiles      | 434 |
| Schede rilievo misure Measurement form | 444 |

Misure speciali Special size

|       |        |
|-------|--------|
| H max | 210 cm |
| L min | 30 cm  |
| L max | 180 cm |

supplementi

|                         |                                      |   |  |  |  |  |  |  |  |  |
|-------------------------|--------------------------------------|---|--|--|--|--|--|--|--|--|
| Decografia Decoprinting | Sigillante SPARTAN® Sealant SPARTAN® |   |  |  |  |  |  |  |  |  |
|                         | €                                    | € |  |  |  |  |  |  |  |  |

per codice for code 36B010010

supplements

|                |       |        |          |       |       |      |      |            |      |             |             |          |            |
|----------------|-------|--------|----------|-------|-------|------|------|------------|------|-------------|-------------|----------|------------|
| 05             | 11    | 12     | 16       | 24    | 25    | 26   | 27   | 28         | 29   | 30          | 31          | 32       | 34         |
| acrilico satin | flack | reflex | satinato | nigol | flute | wave | alon | fumè brown | fumè | trasparente | extrachiaro | cincillà | stampato C |

origin      abitat      vogue  
 59 Nero / 60 Bianco      27 Tcrom® / 21 Tinox® / 22 Tbronz®      61 Orosatinato / 62 Ororosa / 63 Cromonero / 64 Franciacorta / 65 Rame / 66 Brownie / Colori



incluso      included

disponibile      available

## IT-C10

INSTALLAZIONE CENTRALE  
CENTRAL INSTALLATION

## Misure standard

## Standard sizes

| Codice Code | lunghezza lenght | Finiture profili Profiles finishing | 30 | 29 | 28 | 11 |
|-------------|------------------|-------------------------------------|----|----|----|----|
| 07W020090   | 87,3             | origin<br>abitat<br>vogue           |    |    |    |    |
| 07W020100   | 97,3             | origin<br>abitat<br>vogue           |    |    |    |    |
| 07W020120   | 117,3            | origin<br>abitat<br>vogue           |    |    |    |    |
| 07W020140   | 137,3            | origin<br>abitat<br>vogue           |    |    |    |    |

## Misure speciali L / H

## Special sizes L / H

| Codice Code | su misura bespoke | Finiture profili Profiles finishing | 30 | 29 | 28 |
|-------------|-------------------|-------------------------------------|----|----|----|
| 07W029001   | 30 < L < 60       | origin<br>abitat<br>vogue           |    |    |    |
| 07W029001   | 61 < L < 100      | origin<br>abitat<br>vogue           |    |    |    |
| 07W029001   | 101 < L < 140     | origin<br>abitat<br>vogue           |    |    |    |
| 07W029001   | 141 < L < 160     | origin<br>abitat<br>vogue           |    |    |    |
| 07W029001   | 161 < L < 180     | origin<br>abitat<br>vogue           |    |    |    |

## installazioni

## installations

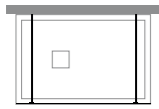
centrale central  
IT-C10

## informazioni

## informations

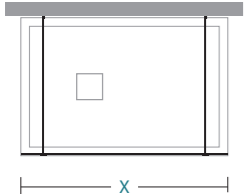
walk-in  
walk-in

| X     |  |  |  |  |  |   |    |
|-------|--|--|--|--|--|---|----|
| 87,3  |  |  |  |  |  | 1 | 49 |
| 97,3  |  |  |  |  |  | 1 | 55 |
| 117,3 |  |  |  |  |  | 1 | 65 |
| 137,3 |  |  |  |  |  | 1 | 76 |

X lunghezza parete doccia\ shower wall length

## attenzione

## warning

Il prezzo della H speciale va trovato nella tabella Misure speciali L / H in base alla L della parete doccia

Special price for H is to be found in **Special sizes L / H** as per L needed size

Optical e Terra - decografia per: vetro Trasparente e Fumè, max L 135 cm

Optical and Terra - decoprinting for: glass Trasparente and Fumè, max L 135 cm

NON abbinabile a Bella B-6 e Leo L-6

NOT to match Bella B-6 and Leo L-6

Incluso: doppio supporto di rinforzo regolabile e snodato

Included: double adjustable, articulated supporting bar

Misure speciali  
Special size

|       |        |
|-------|--------|
| H max | 210 cm |
| L min | 30 cm  |
| L max | 180 cm |

## supplementi

## supplements

|                         |                                      |
|-------------------------|--------------------------------------|
| Decografia Decoprinting | Sigillante SPARTAN® Sealant SPARTAN® |
| €                       | €                                    |

per codice for code 36B010010

|                |           |           |           |           |           |           |           |            |           |             |             |           |            |
|----------------|-----------|-----------|-----------|-----------|-----------|-----------|-----------|------------|-----------|-------------|-------------|-----------|------------|
| <b>05</b>      | <b>11</b> | <b>12</b> | <b>16</b> | <b>24</b> | <b>25</b> | <b>26</b> | <b>27</b> | <b>28</b>  | <b>29</b> | <b>30</b>   | <b>31</b>   | <b>32</b> | <b>34</b>  |
| acrilico satin | flack     | reflex    | satinato  | nigol     | flute     | wave      | alon      | fumè brown | fumè      | trasparente | extrachiaro | cincillà  | stampato C |

origin      abitat      vogue

59 Nero / 60 Bianco      27 Tcrom® / 21 Tinox® / 22 Tbronzo®      61 Orosatinato / 62 Ororosa / 63 Cromonero / 64 Franciacorta / 65 Rame / 66 Brownie / Colori

Approfondimenti  
Insights

|  |     |
|--|-----|
| Indice Index                           | 3   |
| Legenda simboli Icons legend           | 11  |
| Profili - Vetri Profiles - Glasses     | 21  |
| Ricambi Spare parts                    | 406 |
| Profili speciali Special profiles      | 434 |
| Schede rilievo misure Measurement form | 444 |



H cm 200  
6 mm  
REV

incluso

included

disponibile available

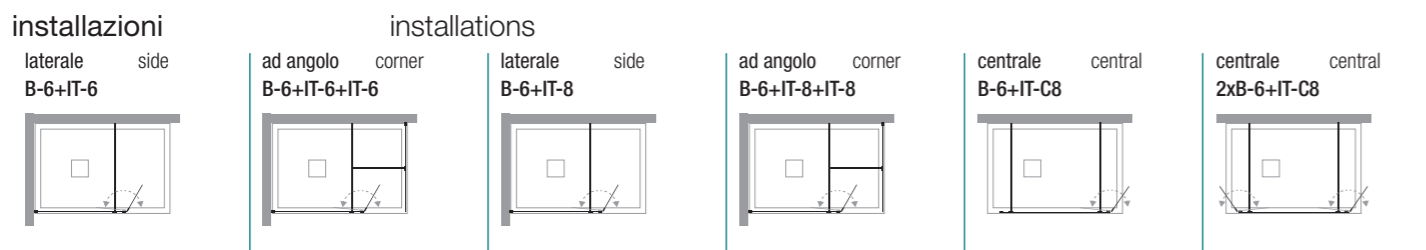

**informazioni** informations

deflettore additional glass

| P  |  |  |  |  |  |   |    |
|----|--|--|--|--|--|---|----|
| 30 |  |  |  |  |  | 1 | 11 |
| 40 |  |  |  |  |  | 1 | 14 |

P lunghezza porta \ door length

**Misure standard** Standard sizes

| Codice Code | estensibilità extension | Finiture profili Profiles finishing | 30 | 16 | 29 | 28 | 31 | 12 |
|-------------|-------------------------|-------------------------------------|----|----|----|----|----|----|
| 07F100030   | 30                      | origin                              |    |    |    |    |    |    |
|             |                         | abitat                              |    |    |    |    |    |    |
|             |                         | vogue                               |    |    |    |    |    |    |
| 07F100040   | 40                      | origin                              |    |    |    |    |    |    |
|             |                         | abitat                              |    |    |    |    |    |    |
|             |                         | vogue                               |    |    |    |    |    |    |

**Misure speciali L / H** Special sizes L / H

| Codice Code | su misura bespoke | Finiture profili Profiles finishing | 30 | 16 | 29 | 28 | 24 | 27 | 31 | 12 |
|-------------|-------------------|-------------------------------------|----|----|----|----|----|----|----|----|
| 07F109001   | 17 < L < 30       | origin                              |    |    |    |    |    |    |    |    |
|             |                   | abitat                              |    |    |    |    |    |    |    |    |
|             |                   | vogue                               |    |    |    |    |    |    |    |    |
| 07F109001   | 31 < L < 50       | origin                              |    |    |    |    |    |    |    |    |
|             |                   | abitat                              |    |    |    |    |    |    |    |    |
|             |                   | vogue                               |    |    |    |    |    |    |    |    |

**attenzione**

Il prezzo della H speciale va trovato nella tabella Misure speciali L / H in base alla L della parete doccia

Special price for H is to be found in Special sizes L / H as per L needed size

**warning**

Abbinabile a IT-6 / IT-8 / IT-C8 e VI-6  
To match IT-6 / IT-8 / IT-C8 and VI-6

Il vetro di B-6 è rialzato dal piatto doccia per permettere la rotazione delle cerniere premontate

B-6 additional glass is able to rotate on the shower tray and hinges are pre-fixed

| Misure speciali Special size | Disponibilità Availability | Tcrom® |
|------------------------------|----------------------------|--------|
| H max 210 cm                 |                            | STOCK  |
| L min 17 cm                  |                            |        |
| L max 50 cm                  |                            |        |

**supplementi**

Decografia Decoprinting

**supplements**

€

per codice for code

|                      |        |          |       |       |      |      |            |      |             |              |          |            |    |
|----------------------|--------|----------|-------|-------|------|------|------------|------|-------------|--------------|----------|------------|----|
| 05                   | 11     | 12       | 16    | 24    | 25   | 26   | 27         | 28   | 29          | 30           | 31       | 32         | 34 |
| acrilico satin flack | reflex | satinato | nigol | flute | wave | alon | fumè brown | fumè | trasparente | extrachiario | cincillà | stampato C |    |

|                     |                                    |  |
|---------------------|------------------------------------|--|
| origin              | abitat                             | vogue  |
| 59 Nero / 60 Bianco | 27 Tcrom® / 21 Tinox® / 22 Tbronz® | 61 Orosatinato / 62 Ororosa / 63 Cromonero / 64 Franciacorta / 65 Rame / 66 Brownie / Colori |

**Approfondimenti**  
Insights



|  |     |
|--|-----|
| Indice Index                           | 3   |
| Legenda simboli Icons legend           | 11  |
| Profili - Vetri Profiles - Glasses     | 21  |
| Ricambi Spare parts                    | 406 |
| Profili speciali Special profiles      | 434 |
| Schede rilievo misure Measurement form | 444 |

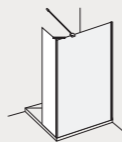

incluso

included



disponibile

available



installazioni

ad angolo corner  
L-6+IT-6

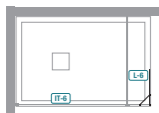

installations

ad angolo corner  
L-6+IT-6

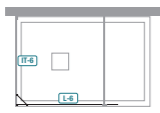

a tre lati three sides  
L-6+IT-6+IT-6

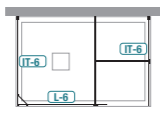

informazioni

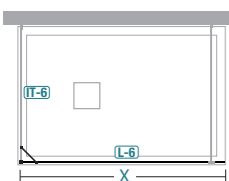

walk-in  
walk-in

informations

| X  | nr | Kg max | X   | nr | Kg max |
|----|----|--------|-----|----|--------|
| 29 | 1  | 11     | 79  | 1  | 28     |
| 39 | 1  | 15     | 89  | 1  | 31     |
| 49 | 1  | 18     | 99  | 1  | 35     |
| 59 | 1  | 21     | 119 | 1  | 41     |
| 69 | 1  | 25     | 139 | 1  | 48     |

X lunghezza parete doccia\ shower wall length

Misure standard

Standard sizes

| Codice Code | estensibilità extension | Finiture profili Profiles finishing | 30 | 16 | 29 | 28 | 31 | 12 | 11 |
|-------------|-------------------------|-------------------------------------|----|----|----|----|----|----|----|
| 07F140030   | 29                      | origin<br>abiat<br>vogue            |    |    |    |    |    |    |    |
| 07F140040   | 39                      | origin<br>abiat<br>vogue            |    |    |    |    |    |    |    |
| 07F140050   | 49                      | origin<br>abiat<br>vogue            |    |    |    |    |    |    |    |
| 07F140060   | 59                      | origin<br>abiat<br>vogue            |    |    |    |    |    |    |    |
| 07F140070   | 69                      | origin<br>abiat<br>vogue            |    |    |    |    |    |    |    |
| 07F140080   | 79                      | origin<br>abiat<br>vogue            |    |    |    |    |    |    |    |
| 07F140090   | 89                      | origin<br>abiat<br>vogue            |    |    |    |    |    |    |    |
| 07F140100   | 99                      | origin<br>abiat<br>vogue            |    |    |    |    |    |    |    |
| 07F140120   | 119                     | origin<br>abiat<br>vogue            |    |    |    |    |    |    |    |
| 07F140140   | 139                     | origin<br>abiat<br>vogue            |    |    |    |    |    |    |    |

| 05                  | 11    | 12     | 16                                 | 24    | 25    | 26   | 27   | 28         | 29   | 30          | 31           | 32       | 34         |
|---------------------|-------|--------|------------------------------------|-------|-------|------|--|------------|------|-------------|--------------|----------|------------|
| acrilico satin      | flack | reflex | satinato                           | nigol | flute | wave | alon   | fumè brown | fumè | trasparente | extrachiario | cincillà | stampato C |
| origin              |       |        | abiat                              |       |       |      | vogue  |            |      |             |              |          |            |
| 59 Nero / 60 Bianco |       |        | 27 Tcrom® / 21 Tinox® / 22 Tbronz® |       |       |      | 61 Orosatinato / 62 Ororosa / 63 Cromonero / 64 Franciacorta / 65 Rame / 66 Brownie / Colori |            |      |             |              |          |            |

| Misure speciali L / H |                      | Special sizes L / H                    |    |    |    |    |    |    |    |    |    |    |
|-----------------------|----------------------|--|----|----|----|----|----|----|----|----|----|----|
| Codice<br>Code        | su misura<br>bespoke | Finiture profili<br>Profiles finishing | 30 | 16 | 29 | 28 | 24 | 25 | 26 | 27 | 31 | 12 |
| 07F149001             | 17 < L < 30          | origin                                 |    |    |    |    |    |    |    |    |    |    |
|                       |                      | abitat                                 |    |    |    |    |    |    |    |    |    |    |
|                       |                      | vogue                                  |    |    |    |    |    |    |    |    |    |    |
| 07F149001             | 31 < L < 60          | origin                                 |    |    |    |    |    |    |    |    |    |    |
|                       |                      | abitat                                 |    |    |    |    |    |    |    |    |    |    |
|                       |                      | vogue                                  |    |    |    |    |    |    |    |    |    |    |
| 07F149001             | 61 < L < 100         | origin                                 |    |    |    |    |    |    |    |    |    |    |
|                       |                      | abitat                                 |    |    |    |    |    |    |    |    |    |    |
|                       |                      | vogue                                  |    |    |    |    |    |    |    |    |    |    |
| 07F149001             | 101 < L < 140        | origin                                 |    |    |    |    |    |    |    |    |    |    |
|                       |                      | abitat                                 |    |    |    |    |    |    |    |    |    |    |
|                       |                      | vogue                                  |    |    |    |    |    |    |    |    |    |    |
| 07F149001             | 141 < L < 160        | origin                                 |    |    |    |    |    |    |    |    |    |    |
|                       |                      | abitat                                 |    |    |    |    |    |    |    |    |    |    |
|                       |                      | vogue                                  |    |    |    |    |    |    |    |    |    |    |
| 07F149001             | 161 < L < 180        | origin                                 |    |    |    |    |    |    |    |    |    |    |
|                       |                      | abitat                                 |    |    |    |    |    |    |    |    |    |    |
|                       |                      | vogue                                  |    |    |    |    |    |    |    |    |    |    |

### attenzione

Il prezzo della H speciale va trovato nella tabella Misure speciali L / H in base alla L della parete doccia

Special price for H is to be found in Special sizes L / H as per L needed size

### warning

Optical e Terra - decografia per: vetro Trasparente e Fumè, max L 135 cm

Optical and Terra - decoprinting for: glass Trasparente and Fumè, max L 135 cm

La lunghezza di IT-6 abbinata a L-6 aumenta di 0,5 cm

The length of IT-6 combined with L-6 increases by 0,5 cm

Incluso: supporto di rinforzo fisso

Included: fixed supporting bar

L-6 deve essere sempre installata su una superficie perfettamente piana

L-6 has to be mounted on a perfect flat surface

Approfondimenti  
Insights



Indice  
Index 3

Legenda simboli  
Icons legend 11

Profili - Vetri  
Profiles - Glasses 21

Ricambi  
Spare parts 406

Profili speciali  
Special profiles 434

Schede rilievo misure  
Measurement form 444

Misure speciali  
Special size

H max 210 cm  
L min 17 cm  
L max 180 cm

### supplementi

### supplements

Decografia  
Decoprinting

Sigillante SPARTAN®  
Sealant SPARTAN®

€

€

per codice  
for code 36B010010

05 11 12 16 24 25 26 27 28 29 30 31 32 34  
 acrilico satin flack reflex satinato nigol flute wave aion fumè brown fumè trasparente extrachiaro cincillà stampato C

origin abitat vogue  
 59 Nero / 60 Bianco 27 Tcrom® / 21 Tinox® / 22 Tbronze® 61 Orosatinato / 62 Ororosa / 63 Cromonero / 64 Franciacorta / 65 Rame / 66 Brownie / Colori



Walk-in installazione ad angolo  
profilo Ororosa / vetro Trasparente  
Piatto doccia ADELMO

Walk-in corner installation  
Ororosa profile / Transparent glass  
Shower tray ADELMO

## VITO

I profili sottili che incorniciano i vetri in spessore 6/8 mm, si manifestano come un dettaglio inedito rendendo la parete doccia un'esperienza visiva originale. Le molteplici possibilità d'installazione e le svariate possibilità di finiture sia per i profili che per i vetri, fanno di questa parete walk-in un prodotto versatile e molto apprezzato. Le lastre in vetro definiscono gli spazi senza creare barriere visive. La possibilità di realizzare installazioni libere e dinamiche lo rendono versatile. Le barre di irrigidimento permettono diverse combinazioni mantenendo un aspetto sobrio e raffinato

The slim 6/8 mm profiles are like a frame for the glasses, which stand out as an original decorative detail, making this shower wall an unusual visual experience. The multiple installation possibilities and the various finishing options, for both profiles and glasses, make this walk-in a versatile and highly appreciated creation. The glass panels define spaces without creating visual barriers. A versatile product, thanks to the endless installation possibilities and dynamism. The support bars leave room to various combinations while maintaining a sober and refined appearance



01



02



02\_a



03

01 profilo perimetrale in finitura | 02 | 02\_a sistemi di supporti abbinabili per combinazioni angolari | 03 cerniera per deflettore Bella con rotazione 170° (80° + 90°) |

01 in ground profile matching finish | 02 | 02\_a combinable supports for corner installations | 03 Bella hinges 170° (80°+90°) |



### CARATTERISTICHE FEATURES

- H cm 200** ALTEZZA PARETI DOCCIA  
SHOWER DOOR HEIGHT
- SP mm** SPESSORE LASTRA 6/8  
GLASS DEPTH
- REV** REVERSIBILE  
REVERSIBLE

### INFO TECNICHE TECHNICAL INFORMATION

- REGOLAZIONE FUORI SQUADRO**  
OFF-SQUARE REGULATION
- 1 cm** ESTENSIBILITÀ  
EXSTENSIBILITY
- NEVERDROP®** TRATTAMENTO NEVERDROP®  
NEVERDROP® TREATMENT

### Finiture profili

#### ORIGIN

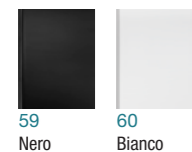

### Profiles finishing

#### ABITAT

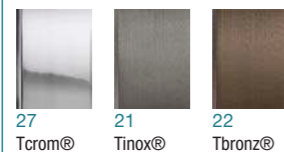

#### VOGUE

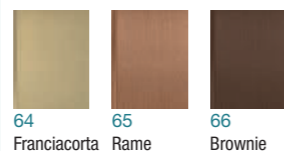
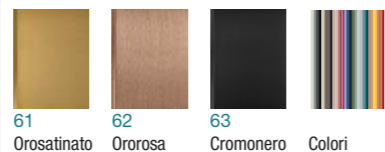

### Vetri

### Glasses

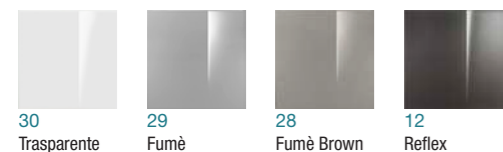

### in nicchia

VI-6/8

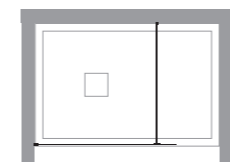

VI-6+B-6

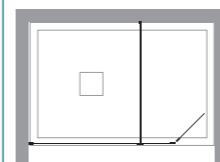

### niche

### ad angolo

VI-6/8

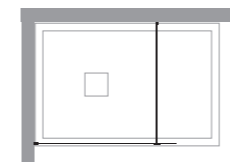

VI-6+B-6

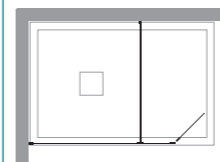

### corner

VI-6+VI-6

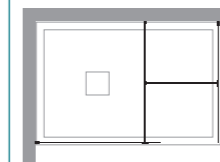

VI-6+VI-6 +B-6

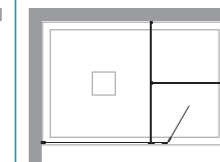

### centrale

VI-C8

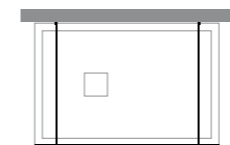

### central

### installazioni particolari

VI-6+VI-8

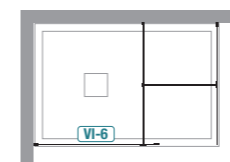

VI-6+B-6+VI-8

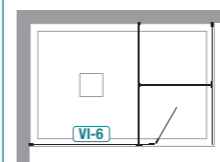

### special installations

### profili

### profiles

per/for VI-6

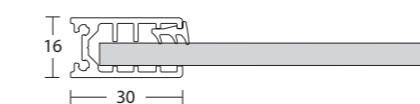

profilo a muro 1135 + guarnizione 78x10

wall profile 1135 + seal 78x10

per/for VI-8

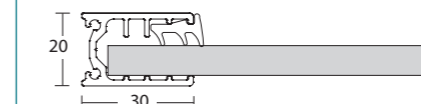

profilo a muro 1115 + guarnizione 78x14

wall profile 1115 + seal 78x14

### importante

### important

per installazioni particolari richiedere fattibilità. Alcune configurazioni necessitano di elementi aggiuntivi

contact TDA technical office for particular installation. More elements could be needed

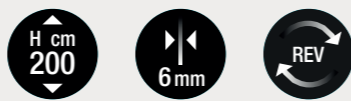
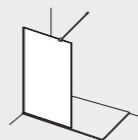

incluso included



disponibile available



Misure standard

Standard sizes

| Codice Code | estensibilità extension | Finiture profili Profiles finishing | 30 | 29 | 28 | 12 |
|-------------|-------------------------|-------------------------------------|----|----|----|----|
| 07F150090   | 88-89                   | origin<br>abitat<br>vogue           |    |    |    |    |
| 07F150100   | 98-99                   | origin<br>abitat<br>vogue           |    |    |    |    |
| 07F150110   | 108-109                 | origin<br>abitat<br>vogue           |    |    |    |    |
| 07F150120   | 118-119                 | origin<br>abitat<br>vogue           |    |    |    |    |
| 07F150130   | 128-129                 | origin<br>abitat<br>vogue           |    |    |    |    |
| 07F150140   | 138-139                 | origin<br>abitat<br>vogue           |    |    |    |    |
| 07F150150   | 148-149                 | origin<br>abitat<br>vogue           |    |    |    |    |
| 07F150160   | 158-159                 | origin<br>abitat<br>vogue           |    |    |    |    |

installazioni

laterale side  
VI-6

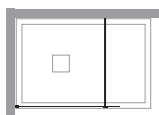

installations

laterale side  
VI-6+B-6

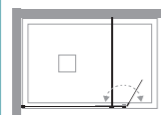

ad angolo corner  
VI-6+VI-6

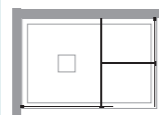

ad angolo corner  
VI-6+VI-6+B-6

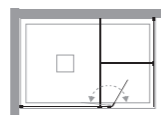

informazioni

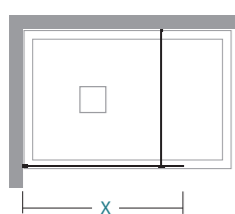

x lunghezza parete doccia\ shower wall length

informations

| X       |  |  |  |  |  |  |  | nr | Kg max |
|---------|--|--|--|--|--|--|--|----|--------|
| 88-89   |  |  |  |  |  |  |  | 1  | 30     |
| 98-99   |  |  |  |  |  |  |  | 1  | 35     |
| 108-109 |  |  |  |  |  |  |  | 1  | 39     |
| 118-119 |  |  |  |  |  |  |  | 1  | 42     |
| 128-129 |  |  |  |  |  |  |  | 1  | 45     |
| 138-139 |  |  |  |  |  |  |  | 1  | 49     |
| 148-149 |  |  |  |  |  |  |  | 1  | 52     |
| 158-159 |  |  |  |  |  |  |  | 1  | 55     |

attenzione

Abbinabile a Bella B-6

To match Bella B-6

Misure speciali  
Special size

warning

Incluso: supporto di rinforzo regolabile e snodato con connettore a T

Included: adjustable, articulated supporting bar with T-connector

Tutti i componenti della parete doccia sono in finitura

All components have the same finishing

supplementi

Sigillante SPARTAN®  
Sealant SPARTAN®

€

36B010010

| 05             | 11    | 12     | 16       | 24    | 25    | 26   | 27   | 28         | 29   | 30          | 31           | 32       | 34         |
|----------------|-------|--------|----------|-------|-------|------|------|------------|------|-------------|--------------|----------|------------|
| acrilico satin | flack | reflex | satinato | nigol | flute | wave | alon | fumè brown | fumè | trasparente | extrachiario | cincillà | stampato C |

| origin              | abitat                             | vogue  |
|---------------------|------------------------------------|--|
| 59 Nero / 60 Bianco | 27 Tcrom® / 21 Tinox® / 22 Tbronz® | 61 Orosatinato / 62 Ororosa / 63 Cromonero / 64 Franciacorta / 65 Rame / 66 Brownie / Colori |

Approfondimenti  
Insights



|   |     |
|---|-----|
| Indice<br>Index                           | 3   |
| Legenda simboli<br>Icons legend           | 11  |
| Profili - Vetri<br>Profiles - Glasses     | 21  |
| Ricambi<br>Spare parts                    | 406 |
| Profili speciali<br>Special profiles      | 434 |
| Schede rilievo misure<br>Measurement form | 444 |

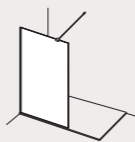

incluso

included



disponibile

available

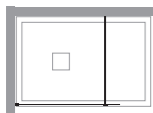

## installazioni

laterale side  
VI-8

## installations

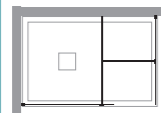
ad angolo corner  
VI-8+VI-8

## informazioni

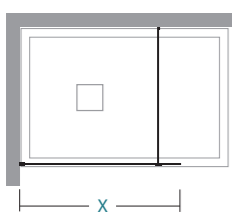
walk-in  
walk-in

## informations

| X       |  |  |  |  |  |  |  |  |  |  | nr | Kg max |
|---------|--|--|--|--|--|--|--|--|--|--|----|--------|
| 88-89   |  |  |  |  |  |  |  |  |  |  | 1  | 41     |
| 98-99   |  |  |  |  |  |  |  |  |  |  | 1  | 45     |
| 108-109 |  |  |  |  |  |  |  |  |  |  | 1  | 50     |
| 118-119 |  |  |  |  |  |  |  |  |  |  | 1  | 54     |
| 128-129 |  |  |  |  |  |  |  |  |  |  | 1  | 58     |
| 138-139 |  |  |  |  |  |  |  |  |  |  | 1  | 63     |
| 148-149 |  |  |  |  |  |  |  |  |  |  | 1  | 67     |
| 158-159 |  |  |  |  |  |  |  |  |  |  | 1  | 71     |

X lunghezza parete doccia\ shower wall length

## Misure standard

## Standard sizes

| Codice<br>Code | estensibilità<br>extension | Finiture profili<br>Profiles finishing | 30 | 29 | 28 | 12 |
|----------------|----------------------------|--|----|----|----|----|
| 07F152090      | 88-89                      | origin<br>abitat<br>vogue              |    |    |    |    |
| 07F152100      | 98-99                      | origin<br>abitat<br>vogue              |    |    |    |    |
| 07F152110      | 108-109                    | origin<br>abitat<br>vogue              |    |    |    |    |
| 07F152120      | 118-119                    | origin<br>abitat<br>vogue              |    |    |    |    |
| 07F152130      | 128-129                    | origin<br>abitat<br>vogue              |    |    |    |    |
| 07F152140      | 138-139                    | origin<br>abitat<br>vogue              |    |    |    |    |
| 07F152150      | 148-149                    | origin<br>abitat<br>vogue              |    |    |    |    |
| 07F152160      | 158-159                    | origin<br>abitat<br>vogue              |    |    |    |    |

## attenzione

## warning

NON abbinabile a BELLA B-6

Incluso: supporto di rinforzo regolabile e snodato con connettore a T

Tutti i componenti della parete doccia sono in finitura

NOT to be combined with BELLA B-6

Included: adjustable, articulated supporting bar with T-connector

All components have the same finishing

Misure speciali  
Special size

## supplementi

## supplements

Sigillante SPARTAN®  
Sealant SPARTAN®

€

36B010010

05 acrilico satin flack 12 reflex 16 satinato 24 nigol 25 flute 26 wave 27 alon 28 fumè brown fumè 29 trasparente 30 extrachiario 31 cincià 32 stampato C 34

origin abitat vogue  
59 Nero / 60 Bianco 27 Tcrom® / 21 Tinox® / 22 Tbronz® 61 Orosatinato / 62 Ororosa / 63 Cromonero / 64 Franciacorta / 65 Rame / 66 Brownie / Colori

Approfondimenti  
Insights

|   |     |
|---|-----|
| Indice<br>Index                           | 3   |
| Legenda simboli<br>Icons legend           | 11  |
| Profili - Vetri<br>Profiles - Glasses     | 21  |
| Ricambi<br>Spare parts                    | 406 |
| Profili speciali<br>Special profiles      | 434 |
| Schede rilievo misure<br>Measurement form | 444 |

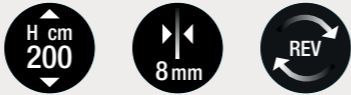
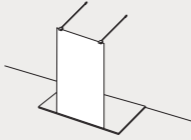

incluso included



disponibile available



#### installazioni

centrale central  
VI-C8

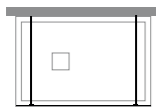

#### informazioni

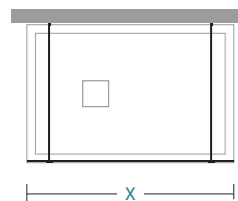

walk-in  
walk-in

X lunghezza parete doccia\ shower wall length

#### installations

#### informations

| X     |  |  |  |  |  |  |  |  | nr | Kg max |
|-------|--|--|--|--|--|--|--|--|----|--------|
| 87,5  |  |  |  |  |  |  |  |  | 1  | 41     |
| 97,5  |  |  |  |  |  |  |  |  | 1  | 45     |
| 107,5 |  |  |  |  |  |  |  |  | 1  | 50     |
| 117,5 |  |  |  |  |  |  |  |  | 1  | 54     |
| 127,5 |  |  |  |  |  |  |  |  | 1  | 58     |
| 137,5 |  |  |  |  |  |  |  |  | 1  | 63     |
| 147,5 |  |  |  |  |  |  |  |  | 1  | 67     |
| 157,5 |  |  |  |  |  |  |  |  | 1  | 71     |

#### Misure standard Standard sizes

| Codice Code | lunghezza lenght | Finiture profili Profiles finishing | 30 | 29 | 28 | 12 |
|-------------|------------------|-------------------------------------|----|----|----|----|
| 07F154090   | 87,5             | origin<br>abitat<br>vogue           |    |    |    |    |
| 07F154100   | 97,5             | origin<br>abitat<br>vogue           |    |    |    |    |
| 07F154110   | 107,5            | origin<br>abitat<br>vogue           |    |    |    |    |
| 07F154120   | 117,5            | origin<br>abitat<br>vogue           |    |    |    |    |
| 07F154130   | 127,5            | origin<br>abitat<br>vogue           |    |    |    |    |
| 07F154140   | 137,5            | origin<br>abitat<br>vogue           |    |    |    |    |
| 07F154150   | 147,5            | origin<br>abitat<br>vogue           |    |    |    |    |
| 07F154160   | 157,5            | origin<br>abitat<br>vogue           |    |    |    |    |

#### attenzione

**NON** abbinabile a BELLA B-6

Incluso: doppio supporto di rinforzo regolabile e snodato

**NOT** to be combined with BELLA B-6

Included: double adjustable, articulated supporting bar

#### warning

Tutti i componenti della parete doccia sono in finitura

All components have the same finishing

Misure speciali Special size

#### supplementi

Sigillante SPARTAN® Sealant SPARTAN®

36B010010

| 05             | 11    | 12     | 16       | 24    | 25    | 26   | 27   | 28         | 29   | 30          | 31          | 32       | 34         |
|----------------|-------|--------|----------|-------|-------|------|------|------------|------|-------------|-------------|----------|------------|
| acrilico satin | flack | reflex | satinato | nigol | flute | wave | alon | fumè brown | fumè | trasparente | extrachiaro | cincillà | stampato C |

origin

59 Nero / 60 Bianco

abitat

27 Tcrom® / 21 Tinox® / 22 Tbronz®

vogue

61 Orosatinato / 62 Ororosa / 63 Cromonero / 64 Franciacorta / 65 Rame / 66 Brownie / Colori

Approfondimenti Insights



Indice Index 3

Legenda simboli Icons legend 11

Profili - Vetri Profiles - Glasses 21

Ricambi Spare parts 406

Profili speciali Special profiles 434

Schede rilievo misure Measurement form 444



Walk-in installazione ad angolo  
profilo Nero / vetro Trasparente  
Piatto doccia AURELIO

Walk-in corner installation  
Nero profile / Transparent glass  
Shower tray AURELIO

## ROCCO

Una serie walk-in che può essere installata a centro stanza grazie al dinamismo dei profili laterali che si estendono fino a un'altezza di 330 cm per essere fissati a soffitto. Lastre in vetro vestono la stanza da bagno senza chiuderne gli spazi, il massimo della pulizia estetica per chi predilige un ambiente minimalista e ricercato

A walk in shower wall series that can be placed right in the middle of a room thanks to the dynamism of its lateral profiles that can extend up to a height of 330 cm to be fixed to the ceiling. Dress up your bathroom with glass walls without closing the space: aesthetic minimalism for a refined and clean space

**01** fissaggio a soffitto per profilo telescopico | **02** particolare di accoppiamento tra lastra e profilo a una via | **03** profilo a terra in finitura |

**01** ceiling mounting for telescopic profile | **02** detail of connection between glass and one way | **03** lower profile with matching finish |



01



02



03



### CARATTERISTICHE FEATURES

- ALTEZZA PARETI DOCCIA  
SHOWER DOOR HEIGHT
- SPESSORE LASTRA  
GLASS DEPTH
- REVERSIBILE  
REVERSIBLE

### INFO TECNICHE TECHNICAL INFORMATION

- PALO TELESCOPICO  
TELESCOPIC POLE
- REGOLAZIONE FUORI SQUADRO  
OFF-SQUARE REGULATION
- ESTENSIBILITÀ  
EXSTENSIBILITY
- TRATTAMENTO NEVERDROP®  
NEVERDROP® TREATMENT
- MISURE SPECIALI  
SPECIAL SIZES
- DECOGRAFIA  
DECOPRINTING

### Finiture profili

#### ORIGIN

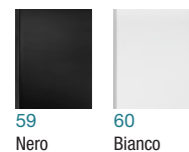

### Profiles finishing

#### ABITAT



#### VOGUE

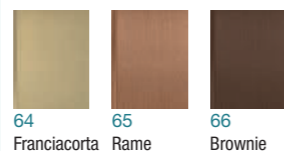
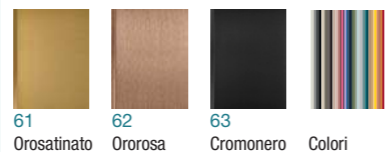

### Vetri

### Glasses

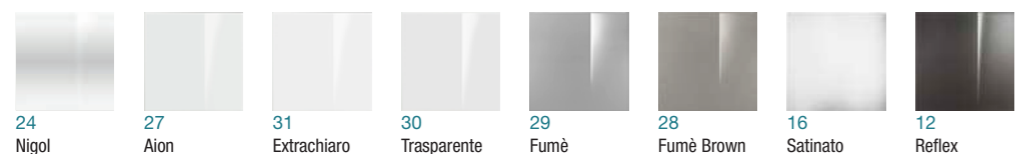

### ad angolo

RO-6

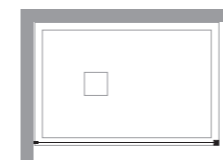

RO-6+RO-L6

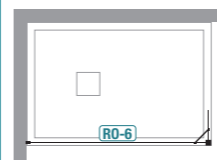

### corner

RO-L6+RO-6

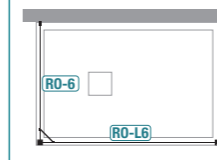

### centrale

RO-C6

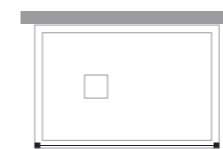

RO-C6+RO-L6

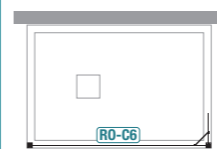

### central

RO-C6+RO-L6+RO-L6

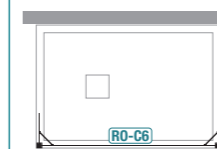

### a tre lati

RO-6+RO-L6+RO-L6

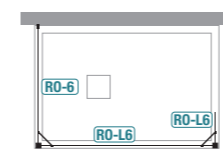

### three sides

### profili

### profiles

per/for RO-6

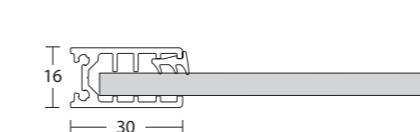

profilo a muro cod. 1135 + guarnizione 78x10

wall profile 1135 + seal 78x10

per/for RO-L6

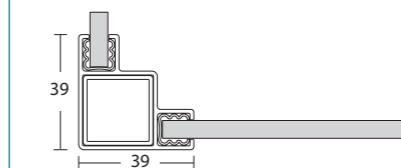

angolare a due vie 1207

two ways corner connection 1207

per/for

### importante

### important

ordini per pareti doccia speciali senza relativo disegno  
NON vengono prodotti

orders for special shower walls without related design are  
NOT produced

per installazioni particolari richiedere fattibilità. Alcune  
configurazioni necessitano di elementi aggiuntivi

contact TDA technical office for particular installation. More  
elements could be needed



**H cm 200** **6 mm** **REV**

**incluso** **included**

**disponibile** **available**

### installazioni

laterale side

RO-6

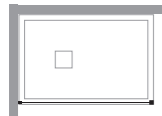

### installations

laterale side

RO-6+RO-L6

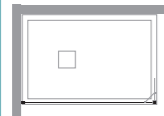

### informazioni

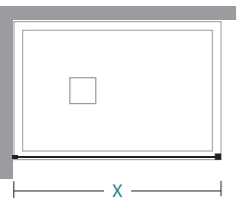

walk-in walk-in

### informations

| X       |  |  |  |  |  |  |  |   |    |
|---------|--|--|--|--|--|--|--|---|----|
| 48-49   |  |  |  |  |  |  |  | 1 | 20 |
| 58-59   |  |  |  |  |  |  |  | 1 | 23 |
| 68-69   |  |  |  |  |  |  |  | 1 | 26 |
| 78-79   |  |  |  |  |  |  |  | 1 | 30 |
| 88-89   |  |  |  |  |  |  |  | 1 | 33 |
| 98-99   |  |  |  |  |  |  |  | 1 | 36 |
| 118-119 |  |  |  |  |  |  |  | 1 | 43 |
| 138-139 |  |  |  |  |  |  |  | 1 | 50 |

X lunghezza parete doccia \ shower wall length

### Misure standard

| Codice Code | estensibilità extension | Finiture profili Profiles finishing | 30 | 16 | 29 | 28 | 31 | 12 |
|-------------|-------------------------|-------------------------------------|----|----|----|----|----|----|
| 07F110050   | 48-49                   | origin<br>abitat<br>vogue           |    |    |    |    |    |    |
| 07F110060   | 58-59                   | origin<br>abitat<br>vogue           |    |    |    |    |    |    |
| 07F110070   | 68-69                   | origin<br>abitat<br>vogue           |    |    |    |    |    |    |
| 07F110080   | 78-79                   | origin<br>abitat<br>vogue           |    |    |    |    |    |    |
| 07F110090   | 88-89                   | origin<br>abitat<br>vogue           |    |    |    |    |    |    |
| 07F110100   | 98-99                   | origin<br>abitat<br>vogue           |    |    |    |    |    |    |
| 07F110120   | 118-119                 | origin<br>abitat<br>vogue           |    |    |    |    |    |    |
| 07F110140   | 138-139                 | origin<br>abitat<br>vogue           |    |    |    |    |    |    |

### Misure speciali L / H

| Codice Code | su misura bespoke | Finiture profili Profiles finishing | 30 | 16 | 29 | 28 | 24 | 27 | 31 | 12 |
|-------------|-------------------|-------------------------------------|----|----|----|----|----|----|----|----|
| 07F119001   | 10 < L < 30       | origin<br>abitat<br>vogue           |    |    |    |    |    |    |    |    |
| 07F119001   | 31 < L < 60       | origin<br>abitat<br>vogue           |    |    |    |    |    |    |    |    |
| 07F119001   | 61 < L < 100      | origin<br>abitat<br>vogue           |    |    |    |    |    |    |    |    |
| 07F119001   | 101 < L < 140     | origin<br>abitat<br>vogue           |    |    |    |    |    |    |    |    |
| 07F119001   | 141 < L < 160     | origin<br>abitat<br>vogue           |    |    |    |    |    |    |    |    |
| 07F119001   | 161 < L < 180     | origin<br>abitat<br>vogue           |    |    |    |    |    |    |    |    |

### attenzione

Il prezzo della H speciale va trovato nella tabella Misure speciali L / H in base alla L della parete doccia

Special price for H is to be found in Special sizes L / H as per L needed size

### warning

Optical e Terra - decografia per: vetro Trasparente e Fumè, max L 135 cm

Optical and Terra - decoprinting for: glass Trasparente and Fumè, max L 135 cm

Abbinabile a RO-L6

To match RO-L6

Incluso: palo telescopico estensibile in altezza fino a 330 cm con fissaggio a soffitto

Included: telescopic profile + ceiling high extension 330 cm

Tutti i componenti della parete doccia sono in finitura

All components have the same finishing

Approfondimenti Insights



|  |     |
|--|-----|
| Indice Index                           | 3   |
| Legenda simboli Icons legend           | 11  |
| Profili - Vetri Profiles - Glasses     | 21  |
| Ricambi Spare parts                    | 406 |
| Profili speciali Special profiles      | 434 |
| Schede rilievo misure Measurement form | 444 |

Misure speciali Special size

|       |        |
|-------|--------|
| H max | 210 cm |
| L min | 10 cm  |
| L max | 180 cm |

Disponibilità Availability

STOCK Tcrom®

### supplementi

Decografia Decoprinting

Sigillante SPARTAN® Sealant SPARTAN®

per codice for code 36B010010

### supplements



|                |       |        |          |       |       |      |      |            |      |             |             |          |            |
|----------------|-------|--------|----------|-------|-------|------|------|------------|------|-------------|-------------|----------|------------|
| 05             | 11    | 12     | 16       | 24    | 25    | 26   | 27   | 28         | 29   | 30          | 31          | 32       | 34         |
| acrilico satin | flack | reflex | satinato | nigol | flute | wave | alon | fumè brown | fumè | trasparente | extrachiaro | cincillà | stampato C |

**origin** 59 Nero / 60 Bianco **abitat** 27 Tcrom® / 21 Tinox® / 22 Tbronze® **vogue** 61 Orosatino / 62 Ororosa / 63 Cromonero / 64 Franciacorta / 65 Rame / 66 Brownie / Colori

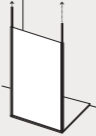





incluso      included

disponibile      available

### installazioni



### informazioni

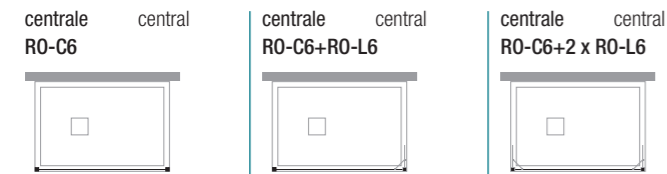

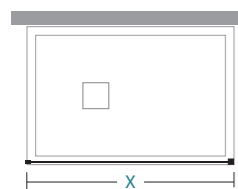
walk-in  
walk-in

### informations

| X   |  |  |  |  |  |  |  |   |    |
|-----|--|--|--|--|--|--|--|---|----|
| 69  |  |  |  |  |  |  |  | 1 | 27 |
| 79  |  |  |  |  |  |  |  | 1 | 31 |
| 89  |  |  |  |  |  |  |  | 1 | 34 |
| 99  |  |  |  |  |  |  |  | 1 | 37 |
| 119 |  |  |  |  |  |  |  | 1 | 44 |
| 139 |  |  |  |  |  |  |  | 1 | 51 |

X lunghezza parete doccia\ shower wall length

### Misure standard

| Codice Code | lunghezza lenght | Finiture profili Profiles finishing | 30 | 16 | 29 | 28 | 31 | 12 |
|-------------|------------------|-------------------------------------|----|----|----|----|----|----|
| 07F120069   | 69               | origin<br>abitat<br>vogue           |    |    |    |    |    |    |
| 07F120079   | 79               | origin<br>abitat<br>vogue           |    |    |    |    |    |    |
| 07F120089   | 89               | origin<br>abitat<br>vogue           |    |    |    |    |    |    |
| 07F120099   | 99               | origin<br>abitat<br>vogue           |    |    |    |    |    |    |
| 07F120119   | 119              | origin<br>abitat<br>vogue           |    |    |    |    |    |    |
| 07F120139   | 139              | origin<br>abitat<br>vogue           |    |    |    |    |    |    |

### Misure speciali L / H

| Codice Code | su misura bespoke | Finiture profili Profiles finishing | 30 | 16 | 29 | 28 | 24 | 27 | 31 | 12 |
|-------------|-------------------|-------------------------------------|----|----|----|----|----|----|----|----|
| 07F129001   | 10 < L < 30       | origin<br>abitat<br>vogue           |    |    |    |    |    |    |    |    |
| 07F129001   | 31 < L < 60       | origin<br>abitat<br>vogue           |    |    |    |    |    |    |    |    |
| 07F129001   | 61 < L < 100      | origin<br>abitat<br>vogue           |    |    |    |    |    |    |    |    |
| 07F129001   | 101 < L < 140     | origin<br>abitat<br>vogue           |    |    |    |    |    |    |    |    |
| 07F129001   | 141 < L < 160     | origin<br>abitat<br>vogue           |    |    |    |    |    |    |    |    |
| 07F129001   | 161 < L < 180     | origin<br>abitat<br>vogue           |    |    |    |    |    |    |    |    |

### attenzione

Il prezzo della H speciale va trovato nella tabella Misure speciali L / H in base alla L della parete doccia

Special price for H is to be found in Special sizes L / H as per L needed size

| Misure speciali Special size |        |  |
|------------------------------|--------|--|
| H max                        | 210 cm |  |
| L min                        | 10 cm  |  |
| L max                        | 180 cm |  |

### supplementi

| Decografia Decoprinting | Sigillante SPARTAN® Sealant SPARTAN® |
|-------------------------|--------------------------------------|
| €                       | €                                    |

per codice for code 36B010010

| 05             | 11    | 12     | 16       | 24    | 25    | 26   | 27   | 28         | 29   | 30          | 31          | 32       | 34         |
|----------------|-------|--------|----------|-------|-------|------|------|------------|------|-------------|-------------|----------|------------|
| acrilico satin | flack | reflex | satinato | nigol | flute | wave | alon | fumè brown | fumè | trasparente | extrachiaro | cincillà | stampato C |

| origin              | abitat                             | vogue  |
|---------------------|------------------------------------|--|
| 59 Nero / 60 Bianco | 27 Tcrom® / 21 Tinox® / 22 Tbronz® | 61 Orosatinato / 62 Ororosa / 63 Cromonero / 64 Franciacorta / 65 Rame / 66 Brownie / Colori |

### warning

Optical e Terra - decografia per: vetro Trasparente e Fumè, max L 135 cm

Optical and Terra - decoprinting for: glass Trasparente and Fumè, max L 135 cm

Abbinabile a RO-L6

To match RO-L6

Inclusi: nr 2 profili telescopici estensibili fino a 330 cm con fissaggio a soffitto

Included: nr 2 - telescopic profiles + ceiling high extension 330 cm L

Tutti i componenti della parete doccia sono in finitura

All components have the same finishing

Approfondimenti Insights



|  |     |
|--|-----|
| Indice Index                           | 3   |
| Legenda simboli Icons legend           | 11  |
| Profili - Vetri Profiles - Glasses     | 21  |
| Ricambi Spare parts                    | 406 |
| Profili speciali Special profiles      | 434 |
| Schede rilievo misure Measurement form | 444 |

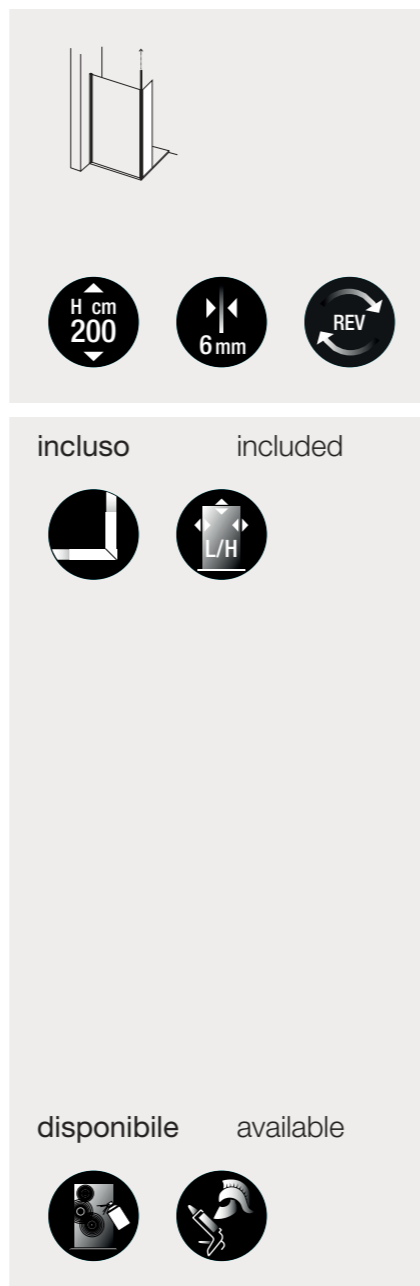

## installazioni

laterale side

RO-6+RO-L6

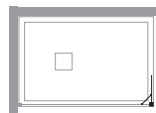

## installations

laterale side

RO-C6+RO-L6

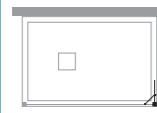

a tre lati three sides

RO-C6+2 x RO-L6

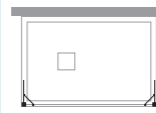

## informazioni

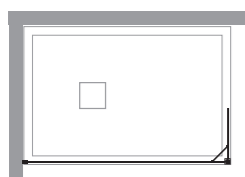
walk-in  
walk-in

## informations

| X  |  |  |  |  |  |  |  |  |  |  |  |  |  |  |  |  |  |  |  |   |    |    |
|----|--|--|--|--|--|--|--|--|--|--|--|--|--|--|--|--|--|--|--|---|----|----|
| 30 |  |  |  |  |  |  |  |  |  |  |  |  |  |  |  |  |  |  |  | 1 | 12 |    |
| 40 |  |  |  |  |  |  |  |  |  |  |  |  |  |  |  |  |  |  |  |   | 1  | 15 |
| 50 |  |  |  |  |  |  |  |  |  |  |  |  |  |  |  |  |  |  |  |   | 1  | 18 |

X lunghezza parete doccia \ shower wall length

## Misure standard

## Standard sizes

| Codice Code | estensibilità extension | Finiture profili Profiles finishing | 30 | 16 | 29 | 28 | 31 | 12 |
|-------------|-------------------------|-------------------------------------|----|----|----|----|----|----|
| 07F130031   | 30                      | origin<br>abiat<br>vogue            |    |    |    |    |    |    |
| 07F130041   | 40                      | origin<br>abiat<br>vogue            |    |    |    |    |    |    |
| 07F130051   | 50                      | origin<br>abiat<br>vogue            |    |    |    |    |    |    |

## Misure speciali L / H

## Special sizes L / H

| Codice Code | su misura bespoke | Finiture profili Profiles finishing | 30 | 16 | 29 | 28 | 24 | 27 | 31 | 12 |
|-------------|-------------------|-------------------------------------|----|----|----|----|----|----|----|----|
| 07F139001   | 10 < L < 30       | origin<br>abiat<br>vogue            |    |    |    |    |    |    |    |    |
| 07F139001   | 31 < L < 60       | origin<br>abiat<br>vogue            |    |    |    |    |    |    |    |    |
| 07F139001   | 61 < L < 100      | origin<br>abiat<br>vogue            |    |    |    |    |    |    |    |    |
| 07F139001   | 101 < L < 140     | origin<br>abiat<br>vogue            |    |    |    |    |    |    |    |    |
| 07F139001   | 141 < L < 160     | origin<br>abiat<br>vogue            |    |    |    |    |    |    |    |    |
| 07F139001   | 161 < L < 180     | origin<br>abiat<br>vogue            |    |    |    |    |    |    |    |    |

## attenzione

## warning

Il prezzo della H speciale va trovato nella tabella Misure speciali L / H in base alla L della parete doccia

Special price for H is to be found in Special sizes L / H as per L needed size

Optical e Terra - decografia per: vetro Trasparente e Fumè, max L 135 cm

Optical and Terra - decoprinting for: glass Trasparente and Fumè, max L 135 cm

Abbinabile a RO-6 e RO-C6

To match RO-6 and RO-C6

Incluso: supporto di rinforzo fisso

Included: fixed supporting bar

Tutti i componenti della parete doccia sono in finitura

All components have the same finishing

Approfondimenti Insights



Indice Index 3

Legenda simboli Icons legend 11

Profili - Vetri Profiles - Glasses 21

Ricambi Spare parts 406

Profili speciali Special profiles 434

Schede rilievo misure Measurement form 444

Misure speciali Special size

H max 210 cm

L max 180 cm

## supplementi

## supplements

Decografia Decoprinting

Sigillante SPARTAN® Sealant SPARTAN®

per codice for code

€ 36B010010 €

05 11 12 16 24 25 26 27 28 29 30 31 32 34  
 acrilico satin flack reflex satinato nigol flute wave aion fumè brown fumè trasparente extrachiaro cincillà stampato C

origin

59 Nero / 60 Bianco

abiat

27 Tcrom® / 21 Tinox® / 22 Tbronz®

vogue

61 Orosatinato / 62 Ororosa / 63 Cromonero / 64 Franciacorta / 65 Rame / 66 Brownie / Colori

## CON PROFILO VERTICALE WITH VERTICAL PROFILE



Porta scorrevole installazione ad angolo  
profilo Tbronz® / vetro Trasparente  
Piatto doccia ADELMO filo pavimento

Sliding door corner installation  
Tbronz® profile / Transparent glass  
Level access shower tray ADELMO

## ENZO

Lo speciale sistema di scorrimento, l'innovativa guida inferiore e la solidità del vetro in spessore 8 mm la delineano come una serie forte e contemporanea. Nata dal tratto del designer Idelfonso Colombo, questa parete doccia esprime nel design dei dettagli il suo grande vigore comunicativo, solida, attuale e funzionale è l'elemento d'arredo ideale per chi predilige un tocco di design distintivo

A truly contemporary and visual shower wall, with a special sliding system, an innovative lower floor guide and a solid of the 8mm-thick glass. From the pen of the Italian designer Idelfonso Colombo, this shower wall strongly communicates through the design of its details; solid, contemporary and functional, the right piece for those who are looking for a design that stands out



01



02



03

01 scorrimento su pattini composti da rulli e guida anodizzata | 02 doppia maniglia esterna / interna | 03 profilo salva-goccia e sistema di sgancio dell'anta |

01 sliding system with rollers and anodized guide | 02 double external / internal handle | 03 lower drip profile with quick door release system |



**CARATTERISTICHE**  
FEATURES

- ALTEZZA PARETI DOCCIA  
SHOWER DOOR HEIGHT
- SPESSORE LASTRA  
GLASS DEPTH
- NON REVERSIBILE  
NON-REVERISBLE

**INFO TECNICHE**  
TECHNICAL INFORMATION

- REGOLAZIONE FUORI SQUADRO  
OFF-SQUARE REGULATION
- ESTENSIBILITÀ  
EXSTENSIBILITY
- SGANCIO VITE  
SCREW RELEASE
- SISTEMA SOFT-CLOSE  
SOFT-CLOSE SYSTEM
- PROFILO MAGNETICO  
MAGNETIC PROFILE
- PROFILO TENUTA ACQUA  
LOW SEAL WATER PROFILE
- MANIGLIE ESTERNA/INTERNA  
EXTERNAL/INTERNAL HANDLES
- TRATTAMENTO NEVERDROP®  
NEVERDROP® TREATMENT
- MISURE SPECIALI  
SPECIAL SIZE

**Finiture profili**

**ORIGIN**

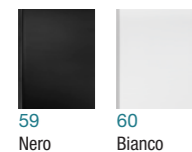

**Profiles finishing**

**ABITAT**



**VOGUE**

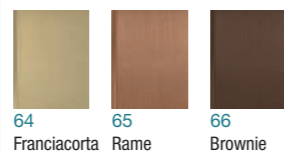
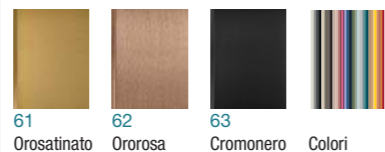

**Vetri**

**Glasses**



**in nicchia**

EN-PSC

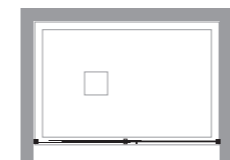

**niche**

**ad angolo**

EN-PSCF+EN-F

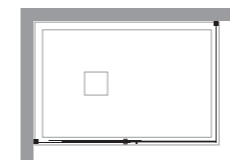

**corner**

**profili**

**profiles**

per/for **EN: PSC-PSCF-F**

per/for

per/for

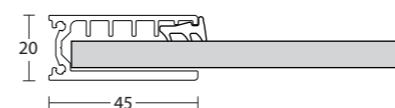

profilo a muro 1575 + guarnizione 78x14

wall profile 1575 + seal 78x14

**importante**

**important**

ordini per pareti doccia speciali senza relativo disegno  
**NON** vengono prodotti

orders for special shower walls without related design are  
**NOT** produced

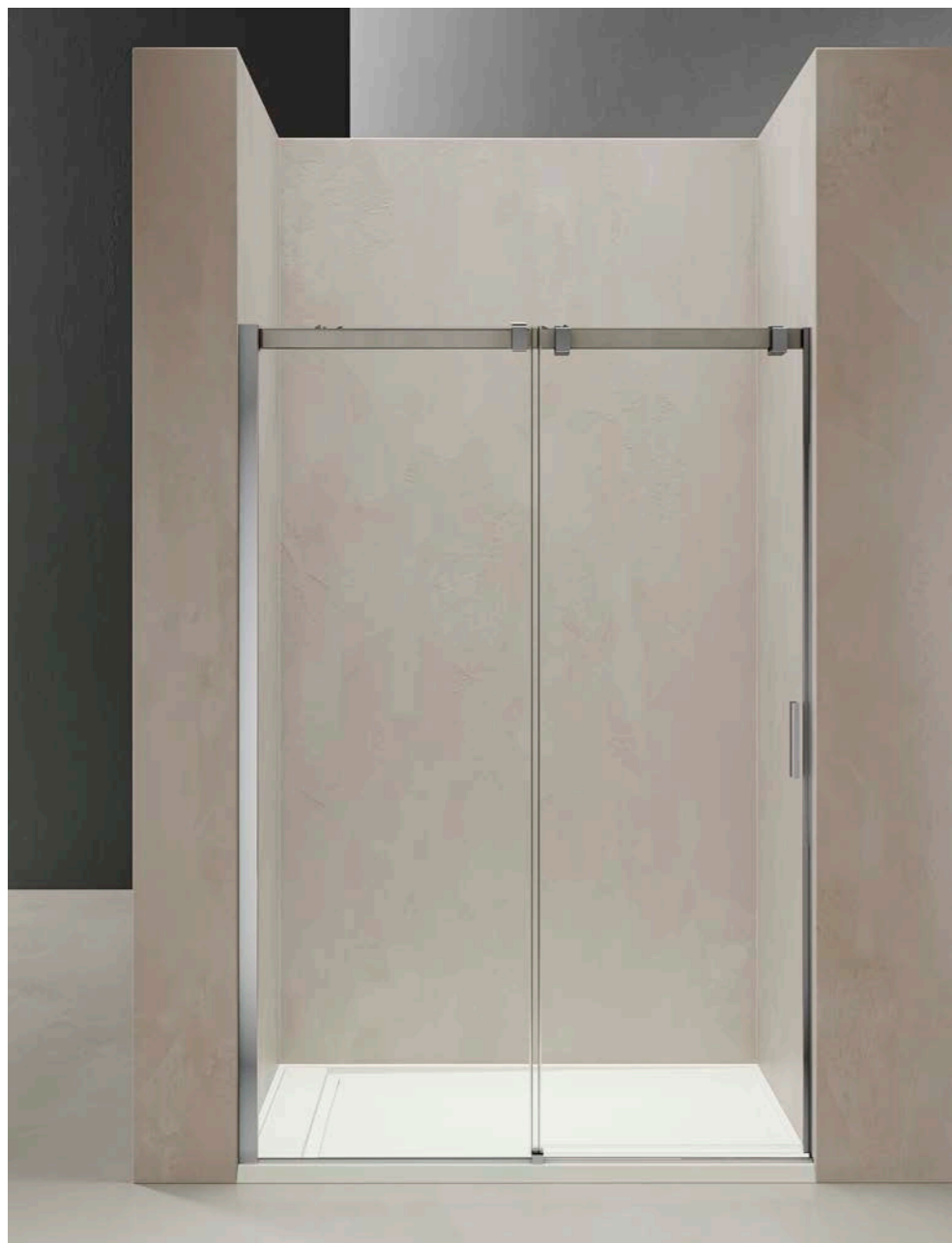





SX  
LH







DX  
RH

incluso





included

disponibile

available



installazioni

in nicchia niche  
EN-PSC



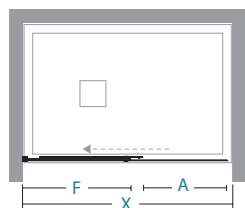

informazioni



installations

apertura scorrevole  
sliding door

informations

|             | X    | A     | F |  |  |  |  |  |  |
|-------------|------|-------|---|--|--|--|--|---|---|
| 97,5-99,5   | 38,5 | 52,5  |   |  |  |  |  | 2   | 46  |
| 107,5-109,5 | 43,5 | 57,5  |   |  |  |  |  | 2   | 50  |
| 117,5-119,5 | 48,5 | 62,5  |   |  |  |  |  | 2   | 54  |
| 127,5-129,5 | 53,5 | 67,5  |   |  |  |  |  | 2   | 58  |
| 137,5-139,5 | 58,5 | 72,5  |   |  |  |  |  | 2   | 62  |
| 147,5-149,5 | 63,5 | 77,5  |   |  |  |  |  | 2   | 66  |
| 157,5-159,5 | 68,5 | 82,5  |   |  |  |  |  | 2   | 70  |
| 167,5-169,5 | 68,5 | 92,5  |   |  |  |  |  | 2   | 74  |
| 177,5-179,5 | 68,5 | 102,5 |   |  |  |  |  | 2   | 78  |

X lunghezza parete doccia\ shower wall length  
A spazio d'entrata\ entrance space  
F lunghezza lato fisso\ fixed side length

Misure standard

Standard sizes

| Codice SX<br>LH Code | Codice DX<br>RH Code | estensibilità<br>extension | Finiture profili<br>Profiles finishing | 30 | 29 | 28 | 31 |
|----------------------|----------------------|----------------------------|--|----|----|----|----|
| 04P610100            | 04P600100            | 97,5-99,5                  | origin<br>abitat<br>vogue              |    |    |    |    |
| 04P610110            | 04P600110            | 107,5-109,5                | origin<br>abitat<br>vogue              |    |    |    |    |
| 04P610120            | 04P600120            | 117,5-119,5                | origin<br>abitat<br>vogue              |    |    |    |    |
| 04P610130            | 04P600130            | 127,5-129,5                | origin<br>abitat<br>vogue              |    |    |    |    |
| 04P610140            | 04P600140            | 137,5-139,5                | origin<br>abitat<br>vogue              |    |    |    |    |
| 04P610150            | 04P600150            | 147,5-149,5                | origin<br>abitat<br>vogue              |    |    |    |    |
| 04P610160            | 04P600160            | 157,5-159,5                | origin<br>abitat<br>vogue              |    |    |    |    |
| 04P610170            | 04P600170            | 167,5-169,5                | origin<br>abitat<br>vogue              |    |    |    |    |
| 04P610180            | 04P600180            | 177,5-179,5                | origin<br>abitat<br>vogue              |    |    |    |    |

Misure speciali L / H

Special sizes L / H

| Codice SX<br>LH Code | Codice DX<br>RH Code | su misura<br>bespoke | Finiture profili<br>Profiles finishing | 30 | 29 | 28 | 24 | 31 |
|----------------------|----------------------|----------------------|--|----|----|----|----|----|
| 04P619001            | 04P609001            | 90 < L < 100         | origin<br>abitat<br>vogue              |    |    |    |    |    |
| 04P619001            | 04P609001            | 101 < L < 120        | origin<br>abitat<br>vogue              |    |    |    |    |    |
| 04P619001            | 04P609001            | 121 < L < 140        | origin<br>abitat<br>vogue              |    |    |    |    |    |
| 04P619001            | 04P609001            | 141 < L < 160        | origin<br>abitat<br>vogue              |    |    |    |    |    |
| 04P619001            | 04P609001            | 161 < L < 180        | origin<br>abitat<br>vogue              |    |    |    |    |    |

attenzione

Il prezzo della H speciale va trovato nella tabella Misure speciali L / H in base alla L della parete doccia

Special price for H is to be found in Special sizes L / H as per L needed size

warning

Misure speciali  
Special size

|   |     |        |
|---|-----|--------|
| H | max | 210 cm |
| L | min | 90 cm  |
| L | max | 180 cm |

supplementi

Sigillante SPARTAN®  
Sealant SPARTAN®

€

36B010010

| 05             | 11    | 12     | 16       | 24    | 25    | 26   | 27   | 28         | 29   | 30          | 31           | 32       | 34         |
|----------------|-------|--------|----------|-------|-------|------|------|------------|------|-------------|--------------|----------|------------|
| acrilico satin | flack | reflex | satinato | nigol | flute | wave | alon | fumè brown | fumè | trasparente | extrachiario | cincillà | stampato C |

| origin              | abitat                             | vogue  |
|---------------------|------------------------------------|--|
| 59 Nero / 60 Bianco | 27 Tcrom® / 21 Tinox® / 22 Tbronz® | 61 Orosatinato / 62 Ororosa / 63 Cromonero / 64 Franciacorta / 65 Rame / 66 Brownie / Colori |

Approfondimenti  
Insights



|   |     |
|---|-----|
| Indice<br>Index                           | 3   |
| Legenda simboli<br>Icons legend           | 11  |
| Profili - Vetri<br>Profiles - Glasses     | 21  |
| Ricambi<br>Spare parts                    | 406 |
| Profili speciali<br>Special profiles      | 434 |
| Schede rilievo misure<br>Measurement form | 444 |







SX  
LH





DX  
RH

incluso





included

disponibile

available



installazioni

ad angolo corner  
EN-PSCF+EN-F



informazioni

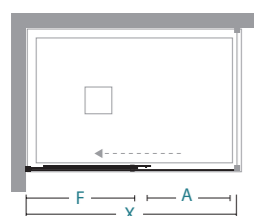

X lunghezza parete doccia\ shower wall length  
A spazio d'entrata\ entrance space  
F lunghezza lato fisso\ fixed side length

installations

informations

apertura scorrevole  
sliding door

|         | X  | A    | F |  |  |  |  |  |   |    |
|---------|----|------|---|--|--|--|--|--|---|----|
| 98-100  | 38 | 52,5 |   |  |  |  |  |  | 2 | 46 |
| 118-120 | 48 | 62,5 |   |  |  |  |  |  | 2 | 54 |
| 128-130 | 53 | 67,5 |   |  |  |  |  |  | 2 | 58 |
| 138-140 | 58 | 72,5 |   |  |  |  |  |  | 2 | 62 |
| 148-150 | 63 | 77,5 |   |  |  |  |  |  | 2 | 66 |
| 158-160 | 68 | 82,5 |   |  |  |  |  |  | 2 | 70 |

EN-PSCF

INSTALLAZIONE AD ANGOLO  
CORNER INSTALLATION

Misure standard

Standard sizes

| Codice SX<br>LH Code | Codice DX<br>RH Code | estensibilità<br>extension | Finiture profili<br>Profiles finishing | 30 | 29 | 28 | 31 |
|----------------------|----------------------|----------------------------|--|----|----|----|----|
| 04P630100            | 04P620100            | 98-100                     | origin<br>abitat<br>vogue              |    |    |    |    |
| 04P630120            | 04P620120            | 118-120                    | origin<br>abitat<br>vogue              |    |    |    |    |
| 04P630130            | 04P620130            | 128-130                    | origin<br>abitat<br>vogue              |    |    |    |    |
| 04P630140            | 04P620140            | 138-140                    | origin<br>abitat<br>vogue              |    |    |    |    |
| 04P630150            | 04P620150            | 148-150                    | origin<br>abitat<br>vogue              |    |    |    |    |
| 04P630160            | 04P620160            | 158-160                    | origin<br>abitat<br>vogue              |    |    |    |    |

Misure speciali L / H

Special sizes L / H

| Codice SX<br>LH Code | Codice DX<br>RH Code | su misura<br>bespoke | Finiture profili<br>Profiles finishing | 30 | 29 | 28 | 24 | 31 |
|----------------------|----------------------|----------------------|--|----|----|----|----|----|
| 04P639001            | 04P629001            | 90 < L < 100         | origin<br>abitat<br>vogue              |    |    |    |    |    |
| 04P639001            | 04P629001            | 101 < L < 120        | origin<br>abitat<br>vogue              |    |    |    |    |    |
| 04P639001            | 04P629001            | 121 < L < 140        | origin<br>abitat<br>vogue              |    |    |    |    |    |
| 04P639001            | 04P629001            | 141 < L < 160        | origin<br>abitat<br>vogue              |    |    |    |    |    |

attenzione

Il prezzo della H speciale va trovato nella tabella Misure speciali L / H in base alla L della parete doccia

Special price for H is to be found in Special sizes L / H as per L needed size

warning

Misure speciali  
Special size

|   |     |        |
|---|-----|--------|
| H | max | 210 cm |
| L | min | 90 cm  |
| L | max | 160 cm |

supplementi

Sigillante SPARTAN®  
Sealant SPARTAN®

36B010010

|                |       |        |          |       |       |      |      |            |      |             |              |          |            |
|----------------|-------|--------|----------|-------|-------|------|------|------------|------|-------------|--------------|----------|------------|
| 05             | 11    | 12     | 16       | 24    | 25    | 26   | 27   | 28         | 29   | 30          | 31           | 32       | 34         |
| acrilico satin | flack | reflex | satinato | nigol | flute | wave | alon | fumè brown | fumè | trasparente | extrachiario | cincillà | stampato C |

|                     |                                    |  |
|---------------------|------------------------------------|--|
| origin              | abitat                             | vogue  |
| 59 Nero / 60 Bianco | 27 Tcrom® / 21 Tinox® / 22 Tbronz® | 61 Orosatinato / 62 Ororosa / 63 Cromonero / 64 Franciacorta / 65 Rame / 66 Brownie / Colori |

Approfondimenti  
Insights



|   |     |
|---|-----|
| Indice<br>Index                           | 3   |
| Legenda simboli<br>Icons legend           | 11  |
| Profili - Vetri<br>Profiles - Glasses     | 21  |
| Ricambi<br>Spare parts                    | 406 |
| Profili speciali<br>Special profiles      | 434 |
| Schede rilievo misure<br>Measurement form | 444 |







SX  
LH





DX  
RH

incluso

included





disponibile



available

installazioni

ad angolo corner  
EN-F+EN-PSCF

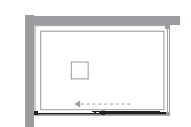

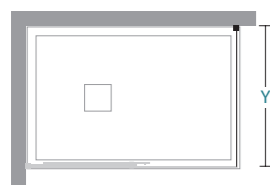

informazioni



Y lunghezza parete doccia \ shower wall length

installations

informations

| Y      |  |  |  |  |  |  |  |  |  |
|--------|--|--|--|--|--|--|--|---|---|
| 68-70  |  |  |  |  |  |  |  | 1   | 31  |
| 73-75  |  |  |  |  |  |  |  | 1   | 33  |
| 78-80  |  |  |  |  |  |  |  | 1   | 35  |
| 83-85  |  |  |  |  |  |  |  | 1   | 37  |
| 88-90  |  |  |  |  |  |  |  | 1   | 39  |
| 98-100 |  |  |  |  |  |  |  | 1   | 43  |

Misure standard

| Codice SX<br>LH Code | Codice DX<br>RH Code | estensibilità<br>extension | Finiture profili<br>Profiles finishing | 30 | 29 | 28 | 31 |
|----------------------|----------------------|----------------------------|--|----|----|----|----|
| 04F310070            | 04F300070            | 68-70                      | origin<br>abitat<br>vogue              |    |    |    |    |
| 04F310075            | 04F300075            | 73-75                      | origin<br>abitat<br>vogue              |    |    |    |    |
| 04F310080            | 04F300080            | 78-80                      | origin<br>abitat<br>vogue              |    |    |    |    |
| 04F310085            | 04F300085            | 83-85                      | origin<br>abitat<br>vogue              |    |    |    |    |
| 04F310090            | 04F300090            | 88-90                      | origin<br>abitat<br>vogue              |    |    |    |    |
| 04F310100            | 04F300100            | 98-100                     | origin<br>abitat<br>vogue              |    |    |    |    |

Misure speciali L / H

| Codice SX<br>LH Code | Codice DX<br>RH Code | su misura<br>bespoke | Finiture profili<br>Profiles finishing | 30 | 29 | 28 | 24 | 31 |
|----------------------|----------------------|----------------------|--|----|----|----|----|----|
| 04F319001            | 04F309001            | 20 < L < 40          | origin<br>abitat<br>vogue              |    |    |    |    |    |
| 04F319001            | 04F309001            | 41 < L < 60          | origin<br>abitat<br>vogue              |    |    |    |    |    |
| 04F319001            | 04F309001            | 61 < L < 80          | origin<br>abitat<br>vogue              |    |    |    |    |    |
| 04F319001            | 04F309001            | 81 < L < 100         | origin<br>abitat<br>vogue              |    |    |    |    |    |
| 04F319001            | 04F309001            | 101 < L < 120        | origin<br>abitat<br>vogue              |    |    |    |    |    |

attenzione

Il prezzo della H speciale va trovato nella tabella Misure speciali L / H in base alla L della parete doccia

Special price for H is to be found in Special sizes L / H as per L needed size

warning

Specificare se installato a pavimento

Specify any floor installation

Misure speciali  
Special size

|   |     |        |
|---|-----|--------|
| H | max | 210 cm |
| L | min | 20 cm  |
| L | max | 120 cm |

supplementi

Sigillante SPARTAN®  
Sealant SPARTAN®

36B010010

|                |       |        |          |       |       |      |      |            |      |             |              |          |            |
|----------------|-------|--------|----------|-------|-------|------|------|------------|------|-------------|--------------|----------|------------|
| 05             | 11    | 12     | 16       | 24    | 25    | 26   | 27   | 28         | 29   | 30          | 31           | 32       | 34         |
| acrilico satin | flack | reflex | satinato | nigol | flute | wave | alon | fumè brown | fumè | trasparente | extrachiario | cincillà | stampato C |

|                     |                                    |  |
|---------------------|------------------------------------|--|
| origin              | abitat                             | vogue  |
| 59 Nero / 60 Bianco | 27 Tcrom® / 21 Tinox® / 22 Tbronz® | 61 Orosatinato / 62 Ororosa / 63 Cromonero / 64 Franciacorta / 65 Rame / 66 Brownie / Colori |

Approfondimenti  
Insights



|   |     |
|---|-----|
| Indice<br>Index                           | 3   |
| Legenda simboli<br>Icons legend           | 11  |
| Profili - Vetri<br>Profiles - Glasses     | 21  |
| Ricambi<br>Spare parts                    | 406 |
| Profili speciali<br>Special profiles      | 434 |
| Schede rilievo misure<br>Measurement form | 444 |

## CON PROFILO VERTICALE WITH VERTICAL PROFILE

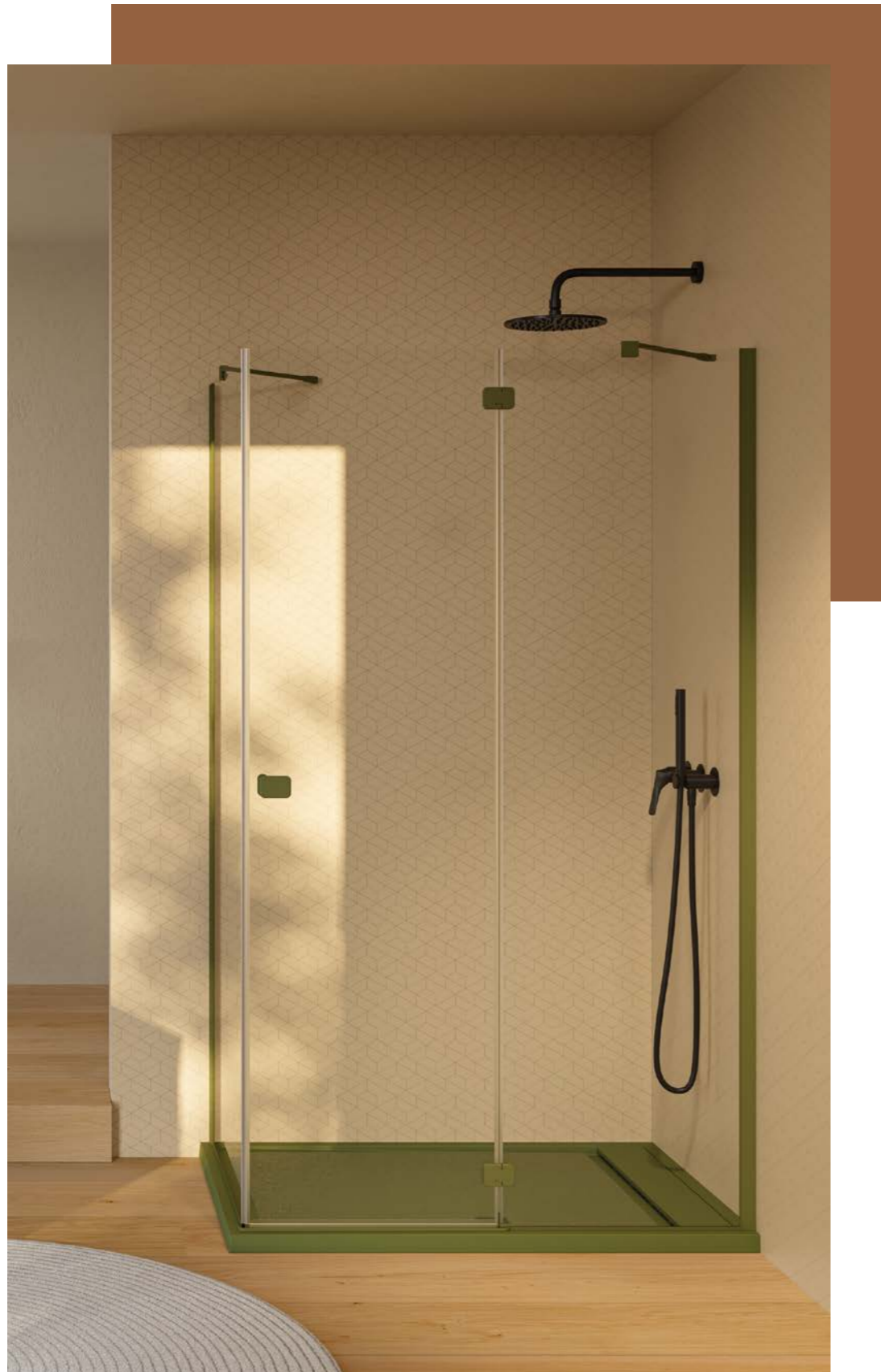

Porta battente installazione ad angolo  
profilo Hunter / vetro Trasparente  
Piatto doccia ADELMO

Hinged door corner installation  
Hunter profile / Transparent glass  
Shower tray ADELMO

### FRIGO

L'installazione ad angolo, le cerniere a filovetro con apertura fino a 110° e il vetro della porta ad angolo di 90° rendono questo modello alternativo e protagonista. Una parete doccia inconfondibile per una stanza da bagno che si fa notare per i vetri delle porte curvati che creano grandi spazi d'ingresso. Le cerniere e la maniglia disegnate da Idelfonso Colombo, un noto designer industriale italiano, completano la grazia di questa delicata serie

The corner installation, the flush hinges with up to 110° opening, and the 90° angled door glass make this model an alternative and protagonist. An unmistakable shower wall for a bathroom that stands out for its curved door glass that creates large entrance spaces. The hinges and handle designed by Idelfonso Colombo, a well-known Italian industrial designer, complete the grace of this delicate series



01



02



03



04



05

**01** maniglia con doppio perno e fissaggio nascosto | **02** cerniera in metallo con fermo in apertura e chiusura | **03** fissaggio della cerniera a filo vetro | **04** guarnizione doppia pinna curvata a caldo in un unico blocco | **05** particolare di raccordo con raggio interno 2cm |

**01** handle with double pin and hidden screws | **02** hinge with opening and closing locking system | **03** glass level hinge installation | **04** double fin seal, curved hot-molded in a single block | **05** detail of connection, inner radius 2 cm |



**CARATTERISTICHE**  
FEATURES

- ALTEZZA PARETI DOCCIA  
SHOWER DOOR HEIGHT
- SPESSORE LASTRA  
GLASS DEPTH
- NON REVERSIBILE  
NON-REVERSIBLE

**INFO TECNICHE**  
TECHNICAL INFORMATION

- VETRO CURVATO 90°  
90° CURVED GLASS
- REGOLAZIONE FUORI SQUADRO  
OFF-SQUARE REGULATION
- ESTENSIBILITÀ  
EXTENSIBILITY
- CERNIERA FILO VETRO  
FLUSH HINGE
- CHIUSURA MAGNETICA  
MAGNETIC CLOSURE
- PROFILO TENUTA ACQUA  
LOW SEAL WATER PROFILE
- MANIGLIA ESTERNA/POMOLO INTERNO  
EXTERNAL HANDLE/INTERNAL POMMEL
- TRATTAMENTO NEVERDROP®  
NEVERDROP® TREATMENT
- MISURE SPECIALI  
SPECIAL SIZES

**Finiture profili**

**ORIGIN**

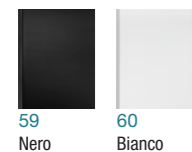

**Profiles finishing**

**ABITAT**



**VOGUE**

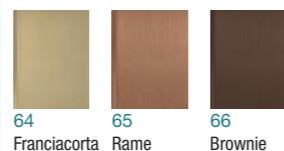
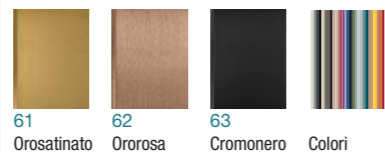

**Vetri**

**Glasses**

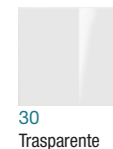

**in nicchia**

FR-ABA

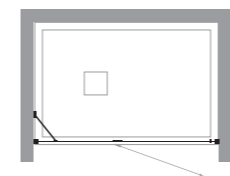

**niche**

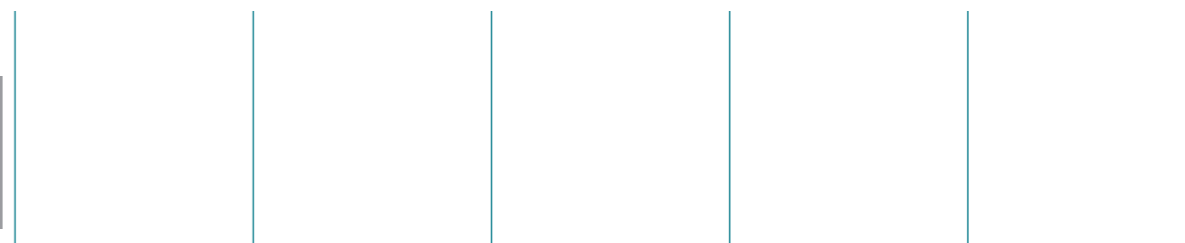

**ad angolo**

FR-PBA+FR-F

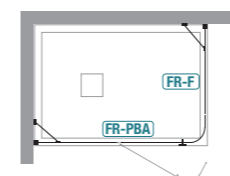

FR-ABA+FR-ABAF

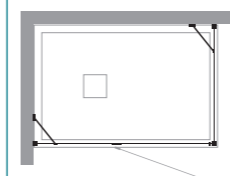

**corner**

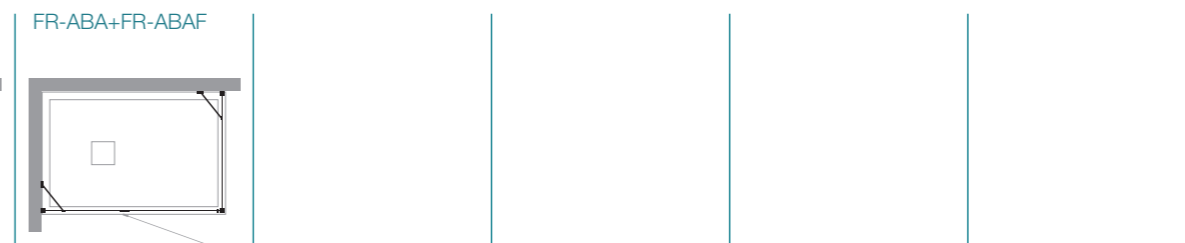

**profili**

**profiles**

per/for **FR: PBA-ABA-ABAF-F**

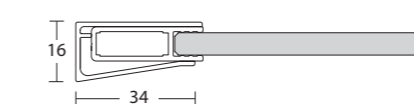

profilo a muro 966 + schienale 261  
wall profile 966 + vertical profile 261

per/for **FR-ABAF**



chiusura con magnete 1128  
magnetic closing 1128

per/for

**importante**

**important**

ordini per pareti doccia speciali senza relativo disegno  
**NON** vengono prodotti

orders for special shower walls without related design are  
**NOT** produced

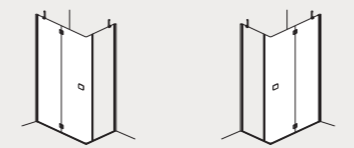
SX  
LHDX  
RH

incluso

included



disponibile

available

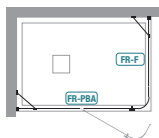

## installazioni

ad angolo corner  
FR-PBA+FR-F

## informazioni

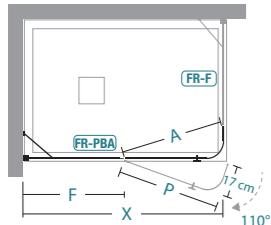

## installations

apertura battente  
swing door

## informations

|         | X     | P/A | F |  |  |  |  |  |   |    |
|---------|-------|-----|---|--|--|--|--|--|---|----|
| 77-79   | 48/50 | 28  |   |  |  |  |  |  | 2 | 35 |
| 87-89   | 48/50 | 38  |   |  |  |  |  |  | 2 | 38 |
| 97-99   | 58/60 | 38  |   |  |  |  |  |  | 2 | 41 |
| 107-109 | 58/60 | 48  |   |  |  |  |  |  | 2 | 45 |
| 117-119 | 58/60 | 58  |   |  |  |  |  |  | 2 | 48 |
| 127-129 | 58/60 | 68  |   |  |  |  |  |  | 2 | 51 |
| 137-139 | 58/60 | 78  |   |  |  |  |  |  | 2 | 55 |

- X lunghezza parete doccia \ shower wall length  
 A spazio d'entrata \ entrance space  
 P lunghezza porta \ door length  
 F lunghezza lato fisso \ fixed side length

## Misure standard

## Standard sizes

| Codice SX<br>LH Code | Codice DX<br>RH Code | estensibilità<br>extension | Finiture profili<br>Profiles finishing | 30 |
|----------------------|----------------------|----------------------------|--|----|
| 01A130080            | 01A120080            | 77-79                      | origin<br>abitat<br>vogue              |    |
| 01A130090            | 01A120090            | 87-89                      | origin<br>abitat<br>vogue              |    |
| 01A130100            | 01A120100            | 97-99                      | origin<br>abitat<br>vogue              |    |
| 01A130110            | 01A120110            | 107-109                    | origin<br>abitat<br>vogue              |    |
| 01A130120            | 01A120120            | 117-119                    | origin<br>abitat<br>vogue              |    |
| 01A130130            | 01A120130            | 127-129                    | origin<br>abitat<br>vogue              |    |
| 01A130140            | 01A120140            | 137-139                    | origin<br>abitat<br>vogue              |    |

## Misure speciali L

## Special sizes L

| Codice SX<br>LH Code | Codice DX<br>RH Code | su misura<br>bespoke | Finiture profili<br>Profiles finishing | 30 |
|----------------------|----------------------|----------------------|--|----|
| 01A139001            | 01A129001            | 60 < L < 90          | origin<br>abitat<br>vogue              |    |
| 01A139001            | 01A129001            | 91 < L < 120         | origin<br>abitat<br>vogue              |    |
| 01A139001            | 01A129001            | 121 < L < 150        | origin<br>abitat<br>vogue              |    |
| 01A139001            | 01A129001            | 151 < L < 180        | origin<br>abitat<br>vogue              |    |

## attenzione

## warning

Il prezzo della L speciale va trovato nella tabella Misure speciali L in base alla L della parete doccia

Special price for L is to be found in Special sizes L as per L needed size

Incluso: supporto di rinforzo regolabile e snodato

Included: adjustable, articulated supporting bar

Specificare se installato a pavimento

Specify any floor installation

Approfondimenti  
Insights



|   |     |
|---|-----|
| Indice<br>Index                           | 3   |
| Legenda simboli<br>Icons legend           | 11  |
| Profili - Vetri<br>Profiles - Glasses     | 21  |
| Ricambi<br>Spare parts                    | 406 |
| Profili speciali<br>Special profiles      | 434 |
| Schede rilievo misure<br>Measurement form | 444 |

Misure speciali  
Special size

L max 180 cm  
L min 60 cm

## supplementi

## supplements

Profilo di compensazione 2 cm  
Extension profile 2 cm

Sigillante SPARTAN®  
Sealant SPARTAN®

37P019219

36B010010

05 acrilico satin flack 12 reflex 16 satinato 24 nigol 25 flute 26 wave 27 alon 28 fumè brown fumè 29 trasparente 30 extrachiaro 31 cincià 32 stampato C 34

origin abitat vogue  
 59 Nero / 60 Bianco 27 Tcrom® / 21 Tinox® / 22 Tbronz® 61 Orosatinato / 62 Ororosa / 63 Cromonero / 64 Franciacorta / 65 Rame / 66 Brownie / Colori



H cm 200

6 mm

REV

incluso

included

disponibile

available

installazioni

ad angolo corner  
FR-F+FR-PBA

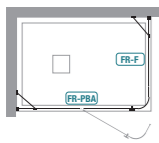

informazioni

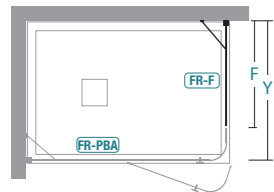

Y lunghezza parete doccia\ shower wall length  
F lunghezza lato fisso\ fixed side length

installations

informations

| Y     | F    |  |  |  |  |  |  |   |    |
|-------|------|--|--|--|--|--|--|---|----|
| 67-69 | 58,5 |  |  |  |  |  |  | 1 | 19 |
| 77-79 | 68,5 |  |  |  |  |  |  | 1 | 22 |
| 87-89 | 78,5 |  |  |  |  |  |  | 1 | 25 |

| Misure standard |                         | Standard sizes                      |    |  |
|-----------------|-------------------------|-------------------------------------|----|--|
| Codice Code     | estensibilità extension | Finiture profili Profiles finishing | 30 |  |
| 01F110070       | 67-69                   | origin<br>abibat<br>vogue           |    |  |
| 01F110080       | 77-79                   | origin<br>abibat<br>vogue           |    |  |
| 01F110090       | 87-89                   | origin<br>abibat<br>vogue           |    |  |

| Misure speciali L |                   | Special sizes L                     |    |  |
|-------------------|-------------------|-------------------------------------|----|--|
| Codice Code       | su misura bespoke | Finiture profili Profiles finishing | 30 |  |
| 01F119001         | 29 < L < 40       | origin<br>abibat<br>vogue           |    |  |
| 01F119001         | 41 < L < 60       | origin<br>abibat<br>vogue           |    |  |
| 01F119001         | 61 < L < 90       | origin<br>abibat<br>vogue           |    |  |
| 01F119001         | 91 < L < 120      | origin<br>abibat<br>vogue           |    |  |

attenzione

Il prezzo della L speciale va trovato nella tabella Misure speciali L in base alla L della parete doccia

Special price for L is to be found in Special sizes L as per L needed size

| Misure speciali Special size |        |  |
|------------------------------|--------|--|
| L max                        | 120 cm |  |
| L min                        | 29 cm  |  |

supplementi

Profilo di compensazione 2 cm  
Extension profile 2 cm

37P019219 €

warning

Incluso: supporto di rinforzo regolabile e snodato

Included: adjustable, articulated supporting bar

Specificare se installato a pavimento

Specify any floor installation

supplements

Sigillante SPARTAN®  
Sealant SPARTAN®

36B010010 €

|                |       |        |          |       |       |      |      |            |      |             |             |          |            |
|----------------|-------|--------|----------|-------|-------|------|------|------------|------|-------------|-------------|----------|------------|
| 05             | 11    | 12     | 16       | 24    | 25    | 26   | 27   | 28         | 29   | 30          | 31          | 32       | 34         |
| acrilico satin | flack | reflex | satinato | nigol | flute | wave | alon | fumè brown | fumè | trasparente | extrachiara | cincillà | stampato C |

origin abitat vogue  
59 Nero / 60 Bianco 27 Tcrom® / 21 Tinox® / 22 Tbronz® 61 Orosatinato / 62 Ororosa / 63 Cromonero / 64 Franciacorta / 65 Rame / 66 Brownie / Colori

Approfondimenti  
Insights



|  |     |
|--|-----|
| Indice Index                           | 3   |
| Legenda simboli Icons legend           | 11  |
| Profili - Vetri Profiles - Glasses     | 21  |
| Ricambi Spare parts                    | 406 |
| Profili speciali Special profiles      | 434 |
| Schede rilievo misure Measurement form | 444 |



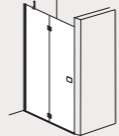

SX  
LH

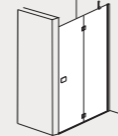

DX  
RH

H cm  
200

6 mm

REV

incluso
included





2 cm















disponibile
available

2 cm



| Misure standard      |                      |                            | Standard sizes                         |    |
|----------------------|----------------------|----------------------------|--|----|
| Codice SX<br>LH Code | Codice DX<br>RH Code | estensibilità<br>extension | Finiture profili<br>Profiles finishing | 30 |
| 01A150080            | 01A140080            | 77,5-79,5                  | origin<br>abitat<br>vogue              |    |
| 01A150090            | 01A140090            | 87,5-89,5                  | origin<br>abitat<br>vogue              |    |
| 01A150100            | 01A140100            | 97,5-99,5                  | origin<br>abitat<br>vogue              |    |
| 01A150110            | 01A140110            | 107,5-109,5                | origin<br>abitat<br>vogue              |    |
| 01A150120            | 01A140120            | 117,5-119,5                | origin<br>abitat<br>vogue              |    |
| 01A150130            | 01A140130            | 127,5-129,5                | origin<br>abitat<br>vogue              |    |
| 01A150140            | 01A140140            | 137,5-139,5                | origin<br>abitat<br>vogue              |    |

| Misure speciali L    |                      |                      | Special sizes L                        |    |
|----------------------|----------------------|----------------------|--|----|
| Codice SX<br>LH Code | Codice DX<br>RH Code | su misura<br>bespoke | Finiture profili<br>Profiles finishing | 30 |
| 01A159001            | 01A149001            | 60 < L < 90          | origin<br>abitat<br>vogue              |    |
| 01A159001            | 01A149001            | 91 < L < 120         | origin<br>abitat<br>vogue              |    |
| 01A159001            | 01A149001            | 121 < L < 150        | origin<br>abitat<br>vogue              |    |
| 01A159001            | 01A149001            | 151 < L < 180        | origin<br>abitat<br>vogue              |    |

installazioni installations

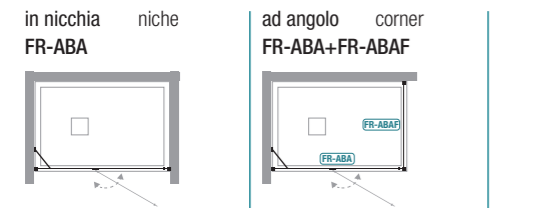

informazioni informations

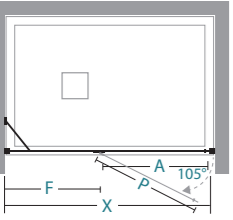

apertura battente  
swing door

|  | X           | A  | F  | P    |  |  |  |  |
|--|-------------|----|----|------|--|--|--|--|
|  | 77,5-79,5   | 46 | 28 | 48,5 |  |  |  |  |
|  | 87,5-89,5   | 56 | 28 | 58,5 |  |  |  |  |
|  | 97,5-99,5   | 56 | 38 | 58,5 |  |  |  |  |
|  | 107,5-109,5 | 56 | 48 | 58,5 |  |  |  |  |
|  | 117,5-119,5 | 66 | 48 | 68,5 |  |  |  |  |
|  | 127,5-129,5 | 66 | 58 | 68,5 |  |  |  |  |
|  | 137,5-139,5 | 66 | 68 | 68,5 |  |  |  |  |

X lunghezza parete doccia \ shower wall length  
 A spazio d'entrata \ entrance space  
 F lunghezza lato fisso \ fixed side length  
 P lunghezza porta \ door length

attenzione warning

Il prezzo della L speciale va trovato nella tabella Misure speciali L in base alla L della parete doccia

Special price for L is to be found in **Special sizes L** as per L needed size

Incluso: supporto di rinforzo regolabile e snodato

Included: adjustable, articulated supporting bar

Specificare se installato a pavimento

Specify any floor installation

| Misure speciali<br>Special size |        |   |           |   |  |  |
|---------------------------------|--------|---|-----------|---|--|--|
| L max                           | 180 cm |   |           |   |  |  |
| L min                           | 60 cm  |   |           |   |  |  |
|                                 |        | € |           | € |  |  |
| 37P019219                       |        |   | 36B010010 |   |  |  |

| 05                  | 11    | 12     | 16                                 | 24    | 25    | 26   | 27   | 28         | 29   | 30          | 31           | 32       | 34         |
|---------------------|-------|--------|------------------------------------|-------|-------|------|--|------------|------|-------------|--------------|----------|------------|
| acrilico satin      | flack | reflex | satinato                           | nigol | flute | wave | alou   | fumè brown | fumè | trasparente | extrachiario | cincillà | stampato C |
| origin              |       |        | abitat                             |       |       |      | vogue  |            |      |             |              |          |            |
| 59 Nero / 60 Bianco |       |        | 27 Tcrom® / 21 Tinox® / 22 Tbronz® |       |       |      | 61 Orosatinato / 62 Ororosa / 63 Cromonero / 64 Franciacorta / 65 Rame / 66 Brownie / Colori |            |      |             |              |          |            |

Approfondimenti  
Insights



|   |     |
|---|-----|
| Indice<br>Index                           | 3   |
| Legenda simboli<br>Icons legend           | 11  |
| Profili - Vetri<br>Profiles - Glasses     | 21  |
| Ricambi<br>Spare parts                    | 406 |
| Profili speciali<br>Special profiles      | 434 |
| Schede rilievo misure<br>Measurement form | 444 |

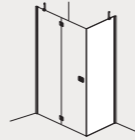

incluso

included



disponibile

available



installazioni

ad angolo corner  
FR-ABAF+FR-ABA

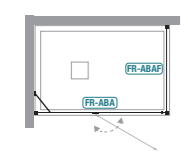

informazioni

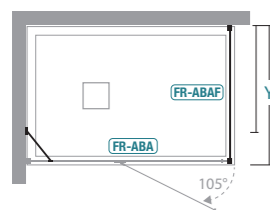

Y lunghezza parete doccia\ shower wall length

installations

informations

| Y         |  |  |  |  |  |  |  |  |  |   |    |
|-----------|--|--|--|--|--|--|--|--|--|---|----|
| 67,5-69,5 |  |  |  |  |  |  |  |  |  | 1 | 19 |
| 77,5-79,5 |  |  |  |  |  |  |  |  |  | 1 | 22 |
| 87,5-89,5 |  |  |  |  |  |  |  |  |  | 1 | 25 |

# FR-ABAF

INSTALLAZIONE AD ANGOLO  
CORNER INSTALLATION

Misure standard Standard sizes

| Codice Code | estensibilità extension | Finiture profili Profiles finishing | 30 |
|-------------|-------------------------|-------------------------------------|----|
| 01F120070   | 67,5-69,5               | origin<br>abitat<br>vogue           |    |
| 01F120080   | 77,5-79,5               | origin<br>abitat<br>vogue           |    |
| 01F120090   | 87,5-89,5               | origin<br>abitat<br>vogue           |    |

Misure speciali L Special sizes L

| Codice Code | su misura bespoke | Finiture profili Profiles finishing | 30 |
|-------------|-------------------|-------------------------------------|----|
| 01F129001   | 16 < L < 60       | origin<br>abitat<br>vogue           |    |
| 01F129001   | 61 < L < 90       | origin<br>abitat<br>vogue           |    |
| 01F129001   | 91 < L < 120      | origin<br>abitat<br>vogue           |    |

attenzione

Il prezzo della L speciale va trovato nella tabella Misure speciali L in base alla L della parete doccia

Special price for L is to be found in Special sizes L as per L needed size

warning

Incluso: supporto di rinforzo regolabile e snodato

Included: adjustable, articulated supporting bar

Specificare se installato a pavimento

Specify any floor installation

Misure speciali Special size

|       |        |
|-------|--------|
| L max | 120 cm |
| L min | 16 cm  |

supplementi

Profilo di compensazione 2 cm  
Extension profile 2 cm

37P019219 €

supplements

Sigillante SPARTAN®  
Sealant SPARTAN®

36B010010 €

Approfondimenti Insights



|  |     |
|--|-----|
| Indice Index                           | 3   |
| Legenda simboli Icons legend           | 11  |
| Profili - Vetri Profiles - Glasses     | 21  |
| Ricambi Spare parts                    | 406 |
| Profili speciali Special profiles      | 434 |
| Schede rilievo misure Measurement form | 444 |

|                |       |        |          |       |       |      |      |            |      |             |              |          |            |
|----------------|-------|--------|----------|-------|-------|------|------|------------|------|-------------|--------------|----------|------------|
| 05             | 11    | 12     | 16       | 24    | 25    | 26   | 27   | 28         | 29   | 30          | 31           | 32       | 34         |
| acrilico satin | flack | reflex | satinato | nigol | flute | wave | alon | fumè brown | fumè | trasparente | extrachiario | cincillà | stampato C |

|                     |                                    |  |
|---------------------|------------------------------------|--|
| origin              | abitat                             | vogue  |
| 59 Nero / 60 Bianco | 27 Tcrom® / 21 Tinox® / 22 Tbronz® | 61 Orosatinato / 62 Ororosa / 63 Cromonero / 64 Franciacorta / 65 Rame / 66 Brownie / Colori |

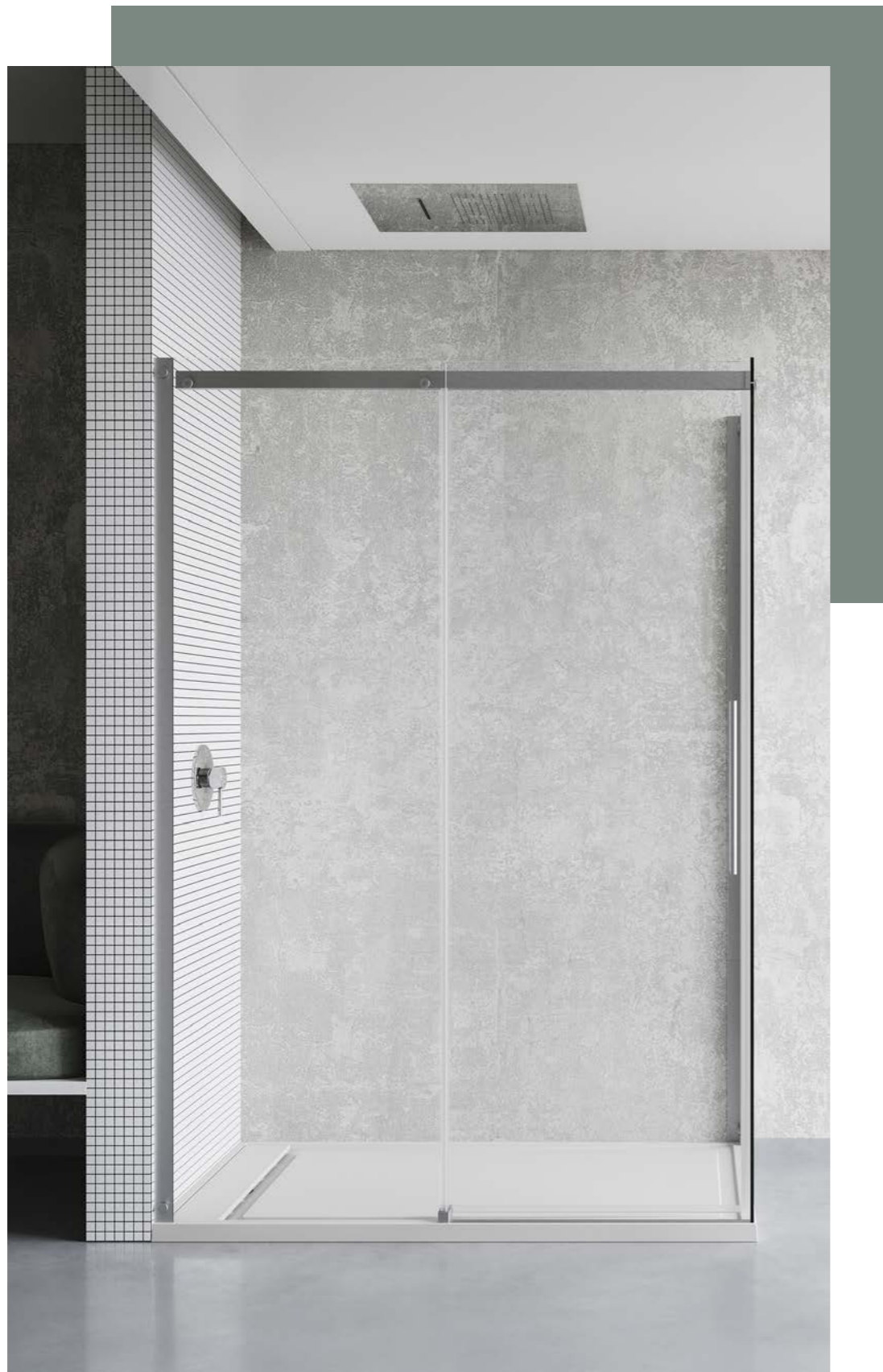

Porta scorrevole installazione ad angolo  
profilo Inox / vetro Trasparente  
Piatto doccia ADELMO

Sliding door corner installation  
Inox profile / Transparent glass  
Shower tray ADELMO

## CON PROFILO VERTICALE WITH VERTICAL PROFILE

### INOX SCROLL

Serie con profili e particolari in acciaio inox dal design prestigioso e raffinato. Le porte sono scorrevoli e silenziose grazie ai paracolpi di fine corsa in apertura. La linea è essenziale e pulita. Il binario, dall'ingombro minimo, posto sulla parte superiore copre solo parzialmente la lunghezza della parete doccia, dando così maggior respiro allo stile della serie. I profili a muro estensibili e la barriera maggiorata offrono una grande adattabilità.

Series with profiles and details made of stainless steel, giving a prestigious and refined look. The sliding doors are silent thanks to the shock absorber buffers. The line is essential and clean. The sliding system is as thin as possible, and in the upper part it partially covers the length of the shower wall, which lightens the overall look. The extensible wall profiles and the raised barrier make this model even more adaptable.



01



02



03

01 binario superiore in acciaio inox con regolazione su eccentrico | 02 sgancio rapido dell'anta | 03 doppia maniglia acciaio inox interna ed esterna, interasse 32 cm |

01 upper rail made of stainless steel with adjustable system | 02 door quick release system | 03 double stainless steel handle, interax 32 cm |



### CARATTERISTICHE FEATURES

-  **H cm 200** ALTEZZA PARETI DOCCIA  
SHOWER DOOR HEIGHT
-  **8 mm** SPESSORE LASTRA  
GLASS DEPTH
-  **NON REVERSIBILE**  
NON-REVERSIBLE

### INFO TECNICHE TECHNICAL INFORMATION

-  **REGOLAZIONE FUORI SQUADRO**  
OFF-SQUARE REGULATION
-  **2 cm** ESTENSIBILITÀ  
EXTENSIBILITY
-  **CHIUSURA AMMORTIZZATA**  
CUSHIONED CLOSURE
-  **GUARNIZIONE PALLONCINO**  
BALLOON SEAL
-  **MANIGLIE ESTERNA/INTERNA**  
EXTERNAL HANDLE/INTERNAL
-  **TRATTAMENTO NEVERDROP®**  
NEVERDROP® TREATMENT
-  **MISURE SPECIALI**  
SPECIAL SIZES
-  **DECOGRAFIA**  
DECOPRINTING

#### Finiture profili

INOX



25  
Inox

#### Profiles finishing

#### Vetri



30  
Trasparente



29  
Fumè



28  
Fumè Brown

#### Glasses

## installazioni previste allowed installations

### in nicchia

IS-PSC

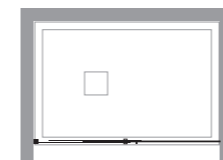

### niche

### ad angolo

IS-PSC + IS-F

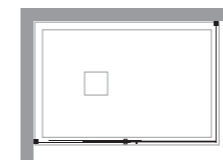

### corner

### profili

### profiles

per/for **IS: PSC-F**

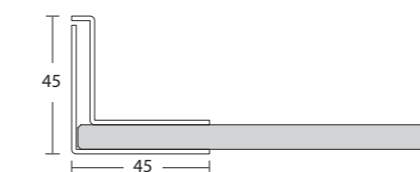

profilo a muro 613 + profilo verticale 614

wall profile 613 + vertical profile 614

per/for

per/for

### importante

### important

ordini per pareti doccia speciali senza relativo disegno  
**NON** vengono prodotti

orders for special shower walls without related design are  
**NOT** produced

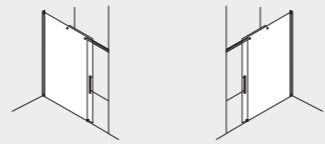
SX  
LHDX  
RH

incluso

included



disponibile

available

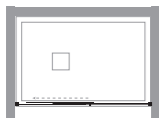

## installazioni

in nicchia  
IS-PSC

## installations

ad angolo  
IS-PSC+IS-F

## informazioni

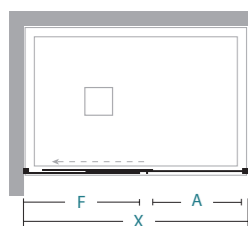

## informations

apertura scorrevole  
sliding door

|         | X  | A   | F |  |  |  |  |  |   |    |
|---------|----|-----|---|--|--|--|--|--|---|----|
| 90-92   | 37 | 44  |   |  |  |  |  |  | 2 | 52 |
| 98-100  | 37 | 54  |   |  |  |  |  |  | 2 | 55 |
| 108-110 | 37 | 64  |   |  |  |  |  |  | 2 | 59 |
| 118-120 | 50 | 59  |   |  |  |  |  |  | 2 | 65 |
| 128-130 | 50 | 69  |   |  |  |  |  |  | 2 | 69 |
| 138-140 | 61 | 68  |   |  |  |  |  |  | 2 | 74 |
| 148-150 | 61 | 78  |   |  |  |  |  |  | 2 | 78 |
| 158-160 | 61 | 88  |   |  |  |  |  |  | 2 | 82 |
| 168-170 | 61 | 98  |   |  |  |  |  |  | 2 | 86 |
| 178-180 | 61 | 108 |   |  |  |  |  |  | 2 | 91 |

X lunghezza parete doccia \ shower wall length  
 A spazio d'entrata \ entrance space  
 F lunghezza lato fisso \ fixed side length

## Misure standard

## Standard sizes

| Codice SX<br>LH Code | Codice DX<br>RH Code | estensibilità<br>extension | Finiture profili<br>Profiles finishing | 30 | 29 | 28 |
|----------------------|----------------------|----------------------------|--|----|----|----|
| 07P130090            | 07P120090            | 90-92                      | inox                                   |    |    |    |
| 07P130100            | 07P120100            | 98-100                     | inox                                   |    |    |    |
| 07P130110            | 07P120110            | 108-110                    | inox                                   |    |    |    |
| 07P130120            | 07P120120            | 118-120                    | inox                                   |    |    |    |
| 07P130130            | 07P120130            | 128-130                    | inox                                   |    |    |    |
| 07P130140            | 07P120140            | 138-140                    | inox                                   |    |    |    |
| 07P130150            | 07P120150            | 148-150                    | inox                                   |    |    |    |
| 07P130160            | 07P120160            | 158-160                    | inox                                   |    |    |    |
| 07P130170            | 07P120170            | 168-170                    | inox                                   |    |    |    |
| 07P130180            | 07P120180            | 178-180                    | inox                                   |    |    |    |

## Misure speciali L

## Special sizes L

| Codice SX<br>LH Code | Codice DX<br>RH Code | estensibilità<br>extension | Finiture profili<br>Profiles finishing | 30 | 29 | 28 |
|----------------------|----------------------|----------------------------|--|----|----|----|
| 07P139001            | 07P129001            | 90 < L < 120               | inox                                   |    |    |    |
| 07P139001            | 07P129001            | 121 < L < 140              | inox                                   |    |    |    |
| 07P139001            | 07P129001            | 141 < L < 160              | inox                                   |    |    |    |
| 07P139001            | 07P129001            | 161 < L < 210              | inox                                   |    |    |    |

## attenzione

Il prezzo della **L** speciale va trovato nella tabella **Misure speciali L** in base alla **L** della parete doccia

Special price for **L** is to be found in **Special sizes L** as per **L** needed size

## warning

Optical e Terra - decografia per: vetro Trasparente, Misure standard e speciali, max L 135 cm

Optical and Terra - decoprinting for: glass Trasparente, Standard and Special sizes, max L 135 cm

Tutti i componenti della parete doccia sono in acciaio inox

All shower wall components are made of stainless steel

Misure speciali  
Special size

L min 90 cm  
L max 210 cm

## supplementi

Profilo di compensazione 1 cm  
Extension profile 1 cm

€ 35A070200 per codice for code

## supplements

Decografia  
Decoprinting

€ 36B010010 Sigillante SPARTAN®  
Sealant SPARTAN®

05 11 12 16 24 25 26 27 28 29 30 31 32 34  
 acrilico satin flack reflex satinato nigol flute wave aion fumè brown fumè trasparente extrachiaro cingilla stampato C

inox  
25 Inox

Approfondimenti  
Insights

|   |     |
|---|-----|
| Indice<br>Index                           | 3   |
| Legenda simboli<br>Icons legend           | 11  |
| Profili - Vetri<br>Profiles - Glasses     | 21  |
| Ricambi<br>Spare parts                    | 406 |
| Profili speciali<br>Special profiles      | 434 |
| Schede rilievo misure<br>Measurement form | 444 |

# Inox Scroll

Parete doccia fissa di profondità  
Fixed panel

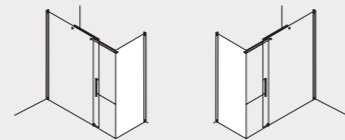

SX LH      DX RH



incluso      included



disponibile      available



## installazioni

ad angolo      corner  
IS-F+IS-PSC



## installations

## informazioni

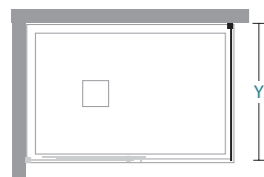

## informations

| Y     |  |  |  |  |  |  |  |  |  |   |    |
|-------|--|--|--|--|--|--|--|--|--|---|----|
| 69-71 |  |  |  |  |  |  |  |  |  | 1 | 35 |
| 77-79 |  |  |  |  |  |  |  |  |  | 1 | 39 |
| 87-89 |  |  |  |  |  |  |  |  |  | 1 | 43 |
| 97-99 |  |  |  |  |  |  |  |  |  | 1 | 47 |

Y lunghezza parete doccia\ shower wall length

# IS-F

INSTALLAZIONE AD ANGOLO  
CORNER INSTALLATION

## Misure standard

Standard sizes

| Codice SX<br>LH Code | Codice DX<br>RH Code | estensibilità<br>extension | Finiture profili<br>Profiles finishing | 30 | 29 | 28 |
|----------------------|----------------------|----------------------------|--|----|----|----|
| 07F210070            | 07F200070            | 69-71                      | inox                                   |    |    |    |
| 07F210080            | 07F200080            | 77-79                      | inox                                   |    |    |    |
| 07F210090            | 07F200090            | 87-89                      | inox                                   |    |    |    |
| 07F210100            | 07F200100            | 97-99                      | inox                                   |    |    |    |

## Misure speciali L

Special sizes L

| Codice SX<br>LH Code | Codice DX<br>RH Code | estensibilità<br>extension | Finiture profili<br>Profiles finishing | 30 | 29 | 28 |
|----------------------|----------------------|----------------------------|--|----|----|----|
| 07F219001            | 07F209001            | 33 < L < 60                | inox                                   |    |    |    |
| 07F219001            | 07F209001            | 61 < L < 80                | inox                                   |    |    |    |
| 07F219001            | 07F209001            | 81 < L < 100               | inox                                   |    |    |    |
| 07F219001            | 07F209001            | 101 < L < 120              | inox                                   |    |    |    |

## attenzione

Il prezzo della L speciale va trovato nella tabella Misure speciali L in base alla L della parete doccia

Special price for L is to be found in Special sizes L as per L needed size

## warning

Optical e Terra - decografia per: vetro Trasparente, Misure standard e speciali, max L 135 cm

Optical and Terra - decoprinting for: glass Trasparente, Standard and Special sizes, max L 135 cm

Tutti i componenti della parete doccia sono in acciaio inox

All shower wall components are made of stainless steel

Specificare se installato a pavimento

Specify any floor installation

Misure speciali  
Special size

|       |        |
|-------|--------|
| L min | 33 cm  |
| L max | 120 cm |

## supplementi

Profilo di compensazione 1 cm  
Extension profile 1 cm

€      per codice for code

## supplements

Decografia  
Decoprinting

€      Sigillante SPARTAN®  
Sealant SPARTAN®

|                |       |        |          |       |       |      |      |            |      |             |             |          |            |
|----------------|-------|--------|----------|-------|-------|------|------|------------|------|-------------|-------------|----------|------------|
| 05             | 11    | 12     | 16       | 24    | 25    | 26   | 27   | 28         | 29   | 30          | 31          | 32       | 34         |
| acrilico satin | flack | reflex | satinato | nigol | flute | wave | alon | fumè brown | fumè | trasparente | extrachiaro | cincillà | stampato C |

inox

25 Inox

## Approfondimenti Insights



|   |     |
|---|-----|
| Indice<br>Index                           | 3   |
| Legenda simboli<br>Icons legend           | 11  |
| Profili - Vetri<br>Profiles - Glasses     | 21  |
| Ricambi<br>Spare parts                    | 406 |
| Profili speciali<br>Special profiles      | 434 |
| Schede rilievo misure<br>Measurement form | 444 |



Porta scorrevole installazione in nicchia  
profilo Inox / vetro Trasparente  
Piatto doccia AURELIO

Sliding door niche installation  
Inox profile / Transparent glass  
Shower tray AURELIO

## CON PROFILO VERTICALE WITH VERTICAL PROFILE

### INOX RAIL

La quasi totale assenza di profili e la presenza di pochi, ma raffinati, dettagli in acciaio Inox con finitura spazzolata, rendono questa serie estremamente tecnica. Le porte sono scorrevoli con fine corsa ammortizzato, l'innovativo sistema scorrevole su binario a terra garantisce la massima fluidità e l'estrema leggerezza verticale, lasciando completamente libera la zona superiore della lastra

A truly technical design: the profile are almost invisible, the stainless steel details are very refined and have a brushed finishing. The sliding doors with cushioned end stops, the innovative sliding system on a floor rail guarantee fluidity and vertical lightness, leaving the upper part of the glass completely free



01



02



03



04

**01** fissaggio a muro in acciaio inox con presa su lastra fissa |  
**02** sistema di guida centrale e sostegno lastra in acciaio inox | **03**  
maniglia inox con doppio pomolo interno, interasse 85 cm | **04**  
binario di scorrimento inferiore in acciaio inox |

**01** stainless steel wall profile | **02** central guiding block and  
stainless steel support | **03** stainless steel handle with double  
knob, interaxe 85 cm | **04** floor rail made of stainless steel



### CARATTERISTICHE FEATURES

-  **H cm 200**  
ALTEZZA PARETI DOCCIA  
SHOWER DOOR HEIGHT
-  **8 mm**  
SPESSORE LASTRA  
GLASS DEPTH
-  **NON REVERSIBILE**  
NON-REVERSIBLE

### INFO TECNICHE TECHNICAL INFORMATION

-  **MODELLO SU MISURA**  
MADE TO MEASURE MODEL
-  **PARACOLPI**  
BUMPERS
-  **MANIGLIA ESTERNA/POMOLO INTERNO**  
EXTERNAL HANDLE/INTERNAL POMMEL
-  **TRATTAMENTO NEVERDROP®**  
NEVERDROP® TREATMENT
-  **DECOGRAFIA**  
DECOPRINTING

#### Finiture profili

INOX



25  
Inox

#### Profiles finishing

#### Vetri



30  
Trasparente

#### Glasses

### in nicchia

IR-PSC

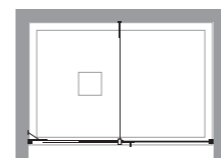

### niche

### ad angolo

IR-ASC

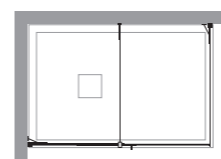

### corner

### semicircolari

IR-TSC

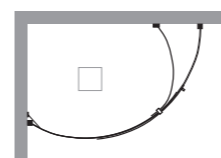

### quadrant

### importante

ordini per pareti doccia speciali senza relativo disegno  
**NON** vengono prodotti

orders for special shower walls without related design are  
**NOT** produced

### important

Rail è una serie inox realizzata su misura

Rail is bespoke inox serie

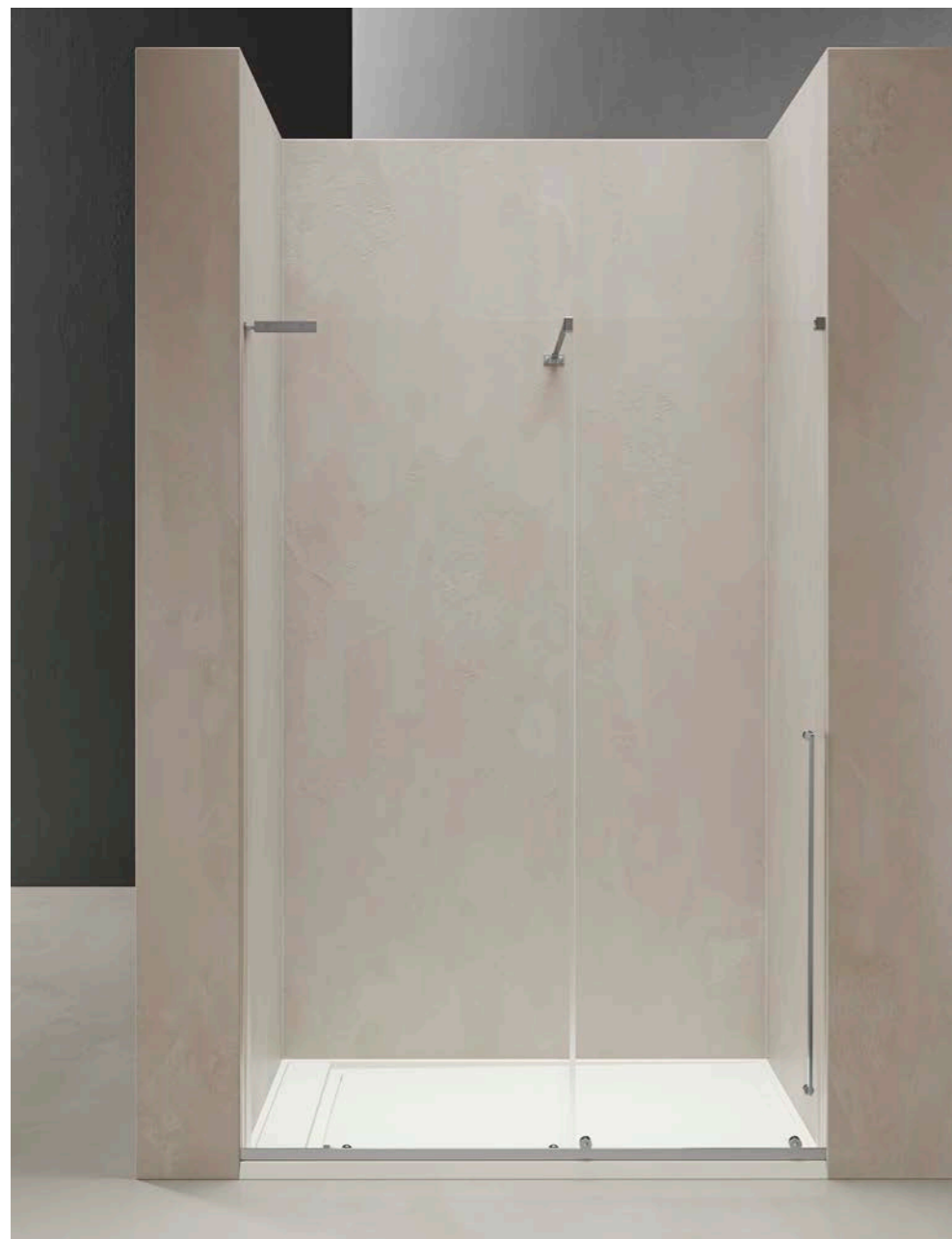

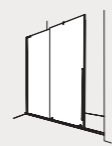

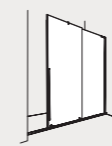

SX  
LH



DX  
RH



H cm  
200



8 mm



RFV

incluso



included

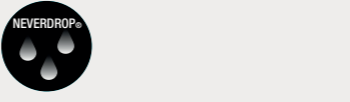

disponibile



available

## Misure speciali L / H Special sizes L / H

| Codice SX<br>LH Code | Codice DX<br>RH Code | su misura<br>bespoke | Finiture profili<br>Profiles finishing | 30 |
|----------------------|----------------------|----------------------|--|----|
| 09P019001            | 09P029001            | 100-119              | inox                                   |    |
| 09P019002            | 09P029002            | 120-139              | inox                                   |    |
| 09P019003            | 09P029003            | 140-159              | inox                                   |    |
| 09P019004            | 09P029004            | 160-180              | inox                                   |    |

### installazioni

in nicchia niche  
IR-PSC

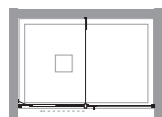

### informazioni

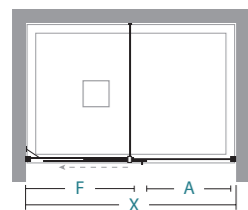



**X** lunghezza parete doccia\ shower wall length  
**A** spazio d'entrata\ entrance space  
**F** lunghezza lato fisso\ fixed side length

### installations

### informations

apertura scorrevole  
sliding door

| X       | A  | F      |  |  |  |  |  |  |  |  |
|---------|----|--------|--|--|--|--|--|--|---|---|
| 100-119 | 44 | 50-70  |  |  |  |  |  |  | 3   | 54  |
| 120-139 | 54 | 60-80  |  |  |  |  |  |  | 3   | 63  |
| 140-159 | 64 | 70-90  |  |  |  |  |  |  | 3   | 71  |
| 160-180 | 64 | 90-110 |  |  |  |  |  |  | 3   | 80  |

### attenzione

Optical e Terra - decografia per: vetro Trasparente. Misure standard e speciali, max L 135 cm

Optical and Terra - decoprinting for: glass Trasparente, Standard and Special sizes, max L 135 cm

### warning

Tutti i componenti della parete doccia sono in acciaio inox

All shower wall components are made of stainless steel

Incluso: supporto angolare di rinforzo e fissaggio in acciaio inox

Included: reinforcing angle bracket and stainless steel fixing

Incluso: tirante angolare in acciaio inox

Included: stainless steel corner bar

### Approfondimenti Insights



|   |     |
|---|-----|
| Indice<br>Index                           | 3   |
| Legenda simboli<br>Icons legend           | 11  |
| Profili - Vetri<br>Profiles - Glasses     | 21  |
| Ricambi<br>Spare parts                    | 406 |
| Profili speciali<br>Special profiles      | 434 |
| Schede rilievo misure<br>Measurement form | 444 |

### supplementi

Decografia  
Decoprinting

Sigillante SPARTAN®  
Sealant SPARTAN®

€

€

per codice  
for code 36B010010

|                |           |           |           |           |           |           |           |            |           |             |             |           |            |
|----------------|-----------|-----------|-----------|-----------|-----------|-----------|-----------|------------|-----------|-------------|-------------|-----------|------------|
| <b>05</b>      | <b>11</b> | <b>12</b> | <b>16</b> | <b>24</b> | <b>25</b> | <b>26</b> | <b>27</b> | <b>28</b>  | <b>29</b> | <b>30</b>   | <b>31</b>   | <b>32</b> | <b>34</b>  |
| acrilico satin | flack     | reflex    | satinato  | nigol     | flute     | wave      | alon      | fumè brown | fumè      | trasparente | extrachiaro | cincillà  | stampato C |

**inox**  
25 Inox

# Inox Rail

Parete doccia con porta scorrevole e fisso di profondità  
Corner shower enclosure with sliding door and side fixed panel



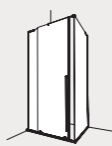

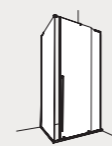

SX  
LH





DX  
RH



incluso



included

disponibile





available

## installazioni

ad angolo corner  
IR-ASC

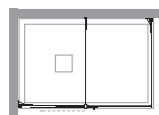

## installations

## informazioni

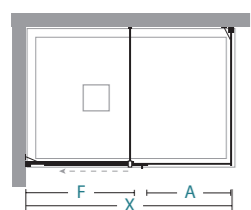

apertura scorrevole  
sliding door

## informations

| X       | Y     | A  | F      |  |  |  |  |   |     |
|---------|-------|----|--------|--|--|--|--|---|-----|
| 100-119 | 70-90 | 42 | 50-70  |  |  |  |  |   |     |
| 120-139 | 70-90 | 52 | 60-80  |  |  |  |  | 4 | 108 |
| 140-159 | 70-90 | 62 | 70-90  |  |  |  |  | 4 | 111 |
| 160-180 | 70-90 | 62 | 90-110 |  |  |  |  | 4 | 117 |

X/Y lunghezza parete doccia\ shower wall length  
A spazio d'entrata\ entrance space  
F lunghezza lato fisso\ fixed side length

# IR-ASC

INSTALLAZIONE AD ANGOLO  
CORNER INSTALLATION

## Misure speciali L / H Special sizes L / H

| Codice SX<br>LH Code | Codice DX<br>RH Code | su misura<br>bespoke | Finiture profili<br>Profiles finishing | 30 |
|----------------------|----------------------|----------------------|--|----|
| 09A019001            | 09A029001            | 100-119X70-90        | inox                                   |    |
| 09A019002            | 09A029002            | 120-139X70-90        | inox                                   |    |
| 09A019003            | 09A029003            | 140-159X70-90        | inox                                   |    |
| 09A019004            | 09A029004            | 160-180X70-90        | inox                                   |    |

## attenzione

Optical e Terra - decografia per: vetro Trasparente. Misure standard e speciali, max L 135 cm

Optical and Terra - decoprinting for: glass Trasparente, Standard and Special sizes, max L 135 cm

## warning

Tutti i componenti della parete doccia sono in acciaio inox

All shower wall components are made of stainless steel

Incluso: supporto angolare di rinforzo e fissaggio in acciaio inox

Included: reinforcing angle bracket and stainless steel fixing

Incluso: tirante angolare in acciaio inox

Included: stainless steel corner bar

## Approfondimenti Insights



|   |     |
|---|-----|
| Indice<br>Index                           | 3   |
| Legenda simboli<br>Icons legend           | 11  |
| Profili - Vetri<br>Profiles - Glasses     | 21  |
| Ricambi<br>Spare parts                    | 406 |
| Profili speciali<br>Special profiles      | 434 |
| Schede rilievo misure<br>Measurement form | 444 |

## supplementi

Decografia  
Decoprinting

Sigillante SPARTAN®  
Sealant SPARTAN®

€ 36B010010 €

per codice  
for code

|                         |        |          |       |       |      |      |                    |             |             |          |            |    |    |
|-------------------------|--------|----------|-------|-------|------|------|--------------------|-------------|-------------|----------|------------|----|----|
| 05                      | 11     | 12       | 16    | 24    | 25   | 26   | 27                 | 28          | 29          | 30       | 31         | 32 | 34 |
| acrilico satin<br>flack | reflex | satinato | nigol | flute | wave | alon | fumè brown<br>fumè | trasparente | extrachiaro | cincillà | stampato C |    |    |

## inox

25 Inox

# Inox Rail

Parete doccia semicircolare con porta scorrevole  
 Quadrant shower enclosure with sliding door



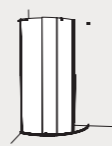

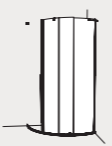

SX  
LH





DX  
RH









incluso

included



disponibile



available

**installazioni**

ad angolo corner  
 IR-TSC

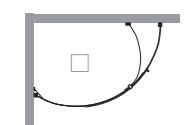

**installations**

**informazioni**

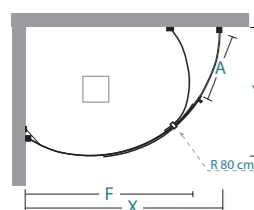

apertura scorrevole  
 sliding door

**informations**

| X   | Y   | A  | F  |  |  |  |  |  |  |  |
|-----|-----|----|----|--|--|--|--|--|---|---|
| 100 | 100 | 58 | 85 |  |  |  |  |  | 3   | 89  |
| 120 | 80  | 55 | 90 |  |  |  |  |  | 3   | 89  |

X/Y lunghezza parete doccia\ shower wall length  
 A spazio d'entrata\ entrance space  
 F lunghezza lato fisso\ fixed side length

# IR-TSC

INSTALLAZIONE AD ANGOLO  
 CORNER INSTALLATION

| Misure standard      |                      |                      | Standard sizes                         |    |
|----------------------|----------------------|----------------------|--|----|
| Codice SX<br>LH Code | Codice DX<br>RH Code | su misura<br>bespoke | Finiture profili<br>Profiles finishing | 30 |
| 09T010001            | 09T010002            | 100X100              | inox                                   |    |
| 09T010003            | 09T010004            | 120X80               | inox                                   |    |

**attenzione**

Raggio di curvatura 80 cm  
  
 Curve radius 80 cm

**warning**

Tutti i componenti della parete doccia sono in acciaio inox  
 Includo: supporto angolare di rinforzo e fissaggio in acciaio inox  
 Includo: tirante angolare in acciaio inox  
 All shower wall components are made of stainless steel  
 Included: reinforcing angle bracket and stainless steel fixing  
 Included: stainless steel corner bar

**supplementi**

Sigillante SPARTAN®  
 Sealant SPARTAN®  
 €  
 36B010010

**supplements**

|                |       |        |          |       |       |      |      |            |      |             |              |          |            |
|----------------|-------|--------|----------|-------|-------|------|------|------------|------|-------------|--------------|----------|------------|
| 05             | 11    | 12     | 16       | 24    | 25    | 26   | 27   | 28         | 29   | 30          | 31           | 32       | 34         |
| acrilico satin | flack | reflex | satinato | nigol | flute | wave | alon | fumè brown | fumè | trasparente | extrachiario | cincillà | stampato C |
| <b>inox</b>    |       |        |          |       |       |      |      |            |      |             |              |          |            |
| 25 Inox        |       |        |          |       |       |      |      |            |      |             |              |          |            |

**Approfondimenti  
 Insights**



|   |     |
|---|-----|
| Indice<br>Index                           | 3   |
| Legenda simboli<br>Icons legend           | 11  |
| Profili - Vetri<br>Profiles - Glasses     | 21  |
| Ricambi<br>Spare parts                    | 406 |
| Profili speciali<br>Special profiles      | 434 |
| Schede rilievo misure<br>Measurement form | 444 |

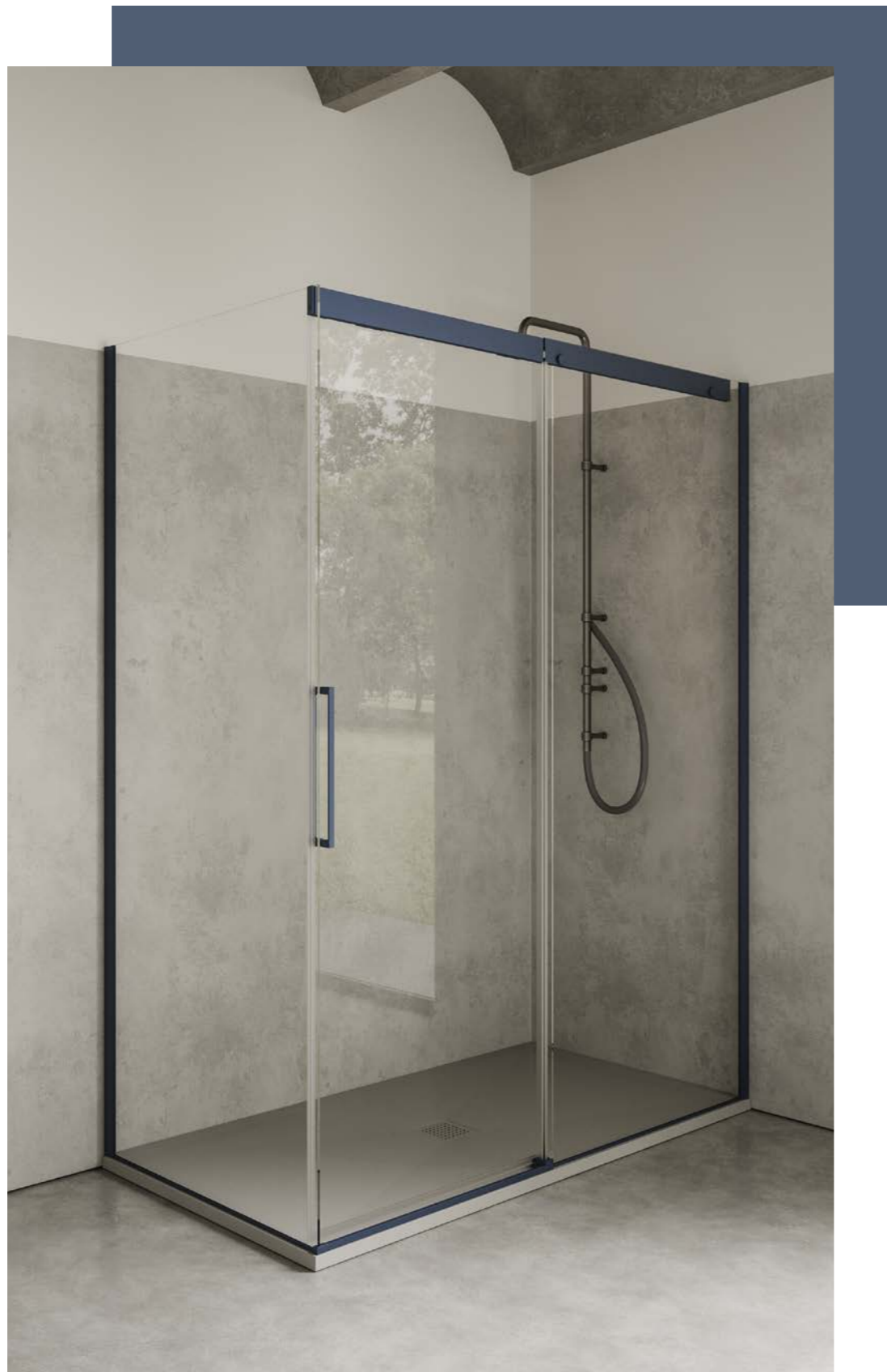

Porta scorrevole installazione ad angolo  
profilo Ocean / vetro Trasparente  
Piatto doccia AMBROGIO

Sliding door corner installation  
Ocean profile / Transparent glass  
Shower tray AMBROGIO

## CON PROFILO VERTICALE WITH VERTICAL PROFILE

### PLUMA EVO

L'innovativo sistema di apertura/chiusura soft-close installato sulle porte scorrevoli e lo sgancio inferiore dell'anta esaltano la struttura rassicurante di questo performante prodotto TDA. Una parete doccia sicura. Grazie al sistema soft-close in apertura/chiusura il movimento di blocco avviene dolcemente e in modo silenzioso. Il suo stile risponde perfettamente alle tendenze di mercato

The innovative soft-close opening/closing system installed on the sliding doors and the bottom panel release enhance the reassuring structure of this high-performance product by TDA. A shower wall that puts safety first. Thanks to the soft-close system, the opening and closing movements are gentle and quiet. Its style perfectly matches market requirements and trends



01



02



03



04

05  
06

**01** giunto per angolo con fissaggio a 45° ed elemento centrale | **02** barra di sostegno registrabile per la massima stabilità | **03** sgancio dell'anta per una migliore pulizia | **04** guida inferiore con sistema per sgancio facilitato dell'anta | **05** maniglia esterna/pomoli interni per PL-ASC | **06** doppia maniglia esterna/interna, interasse 32 cm |

**01** corner connection with 45° fixing and central element | **02** adjustable support for maximum stability | **03** quick release system for easier cleaning | **04** floor rail with quick release system | **05** external handle/inside knob for PL-ASC | **06** double external / internal handle, interaxe 32 cm |





### CARATTERISTICHE FEATURES

-  ALTEZZA PARETI DOCCIA  
SHOWER DOOR HEIGHT
-  SPESSORE LASTRA 6/8  
GLASS DEPTH 6/8
-  NON REVERSIBILE  
NON-REVERSIBLE

### INFO TECNICHE TECHNICAL INFORMATION

-  REGOLAZIONE FUORI SQUADRO  
OFF-SQUARE REGULATION
-  ESTENSIBILITÀ 2/4  
EXSTENSIBILITY 2/4
-  SGANCIO RAPIDO  
QUICK-RELEASE
-  PROFILO TENUTA ACQUA BASSO  
LOW SEAL WATER PROFILE
-  PROFILO TENUTA ACQUA ALTO  
HIGH SEAL WATER PROFILE
-  SISTEMA SOFT-CLOSE  
SOFT-CLOSE SYSTEM
-  PROFILO DI COMPENSAZIONE  
COMPENSATOR PROFILE
-  MANIGLIE ESTERNA/INTERNA  
EXTERNAL/INTERNAL HANDLES
-  TRATTAMENTO NEVERDROP®  
NEVERDROP® TREATMENT
-  MISURE SPECIALI  
SPECIAL SIZES
-  DECOGRAFIA  
DECOPRINTING







### Finiture profili

- ORIGIN**
-  59 Nero
  -  60 Bianco

### Profiles finishing

- ABITAT**
-  27 Tchrom®
  -  21 Tinox®
  -  22 Tbronz®
- VOGUE**
-  61 Orosatinato
  -  62 Ororosa
  -  63 Cromonero
  -  64 Franciacorta
  -  65 Rame
  -  66 Brownie
- Colori**

### Vetri

-  27 Aion
-  30 Trasparente
-  29 Fumè
-  28 Fumè Brown
-  16 Satinato
-  12 Reflex

### Glasses

### in nicchia

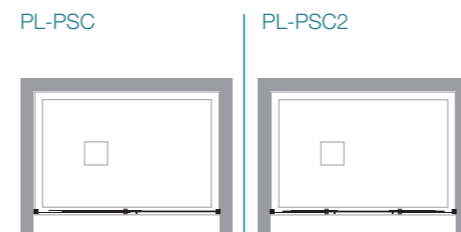

### niche

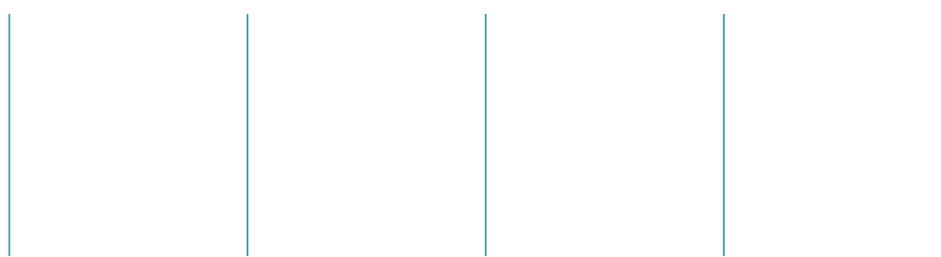

### ad angolo

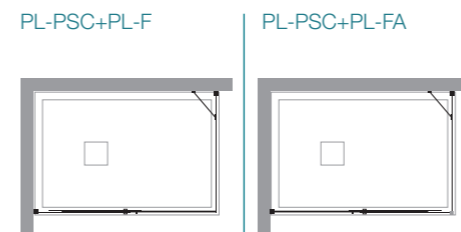

### corner

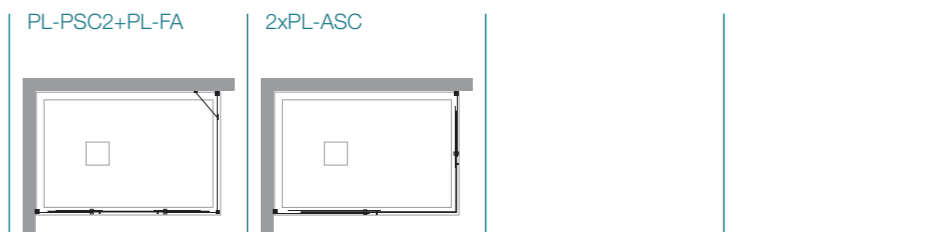

### a tre lati

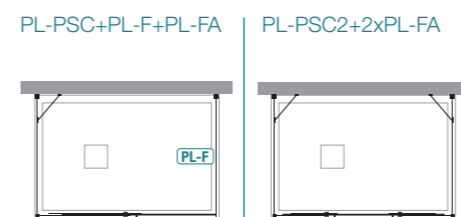

### three sides

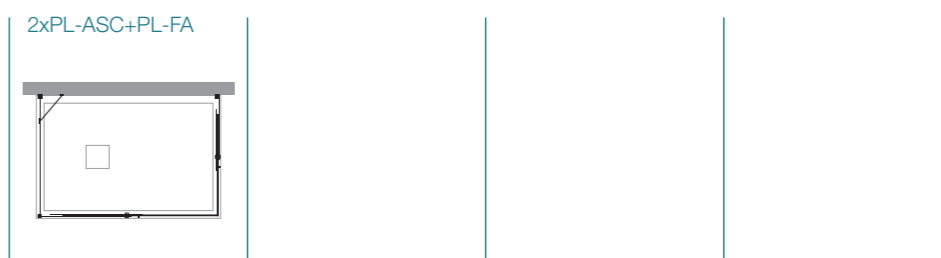

### profili

per/for **PL: PSC-PSC2-ASC-F-FA**

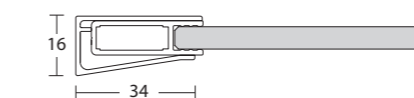

profilo a muro 966 + schienale 261

wall profile 966 + vertical profile 261

### profiles

per/for

per/for

### importante

ordini per pareti doccia speciali senza relativo disegno **NON** vengono prodotti

orders for special shower walls without related design are **NOT** produced

### important

per installazioni a tre lati richiedere fattibilità. Alcune configurazioni necessitano di elementi aggiuntivi

contact TDA technical office for three side installation. Some configurations require additional elements

# Pluma Evo

Parete doccia con porta scorrevole  
Sliding door



SX  
LH

DX  
RH

H cm  
200

6&8  
mm

REV

incluso      included

disponibile      available

## PL-PSC

INSTALLAZIONE IN NICCHIA, AD ANGOLO O A TRE LATI  
NICHE, CORNER OR THREE SIDES INSTALLATION

| Misure standard      |                      |                            | Standard sizes                         |    |    |
|----------------------|----------------------|----------------------------|--|----|----|
| Codice SX<br>LH Code | Codice DX<br>RH Code | estensibilità<br>extension | Finiture profili<br>Profiles finishing | 30 | 12 |
| 07P450100            | 07P440100            | 95-99                      | origin<br>abitat<br>vogue              |    |    |
| 07P450110            | 07P440110            | 105-109                    | origin<br>abitat<br>vogue              |    |    |
| 07P450120            | 07P440120            | 115-119                    | origin<br>abitat<br>vogue              |    |    |
| 07P450130            | 07P440130            | 125-129                    | origin<br>abitat<br>vogue              |    |    |
| 07P450140            | 07P440140            | 135-139                    | origin<br>abitat<br>vogue              |    |    |
| 07P450150            | 07P440150            | 145-149                    | origin<br>abitat<br>vogue              |    |    |
| 07P450160            | 07P440160            | 155-159                    | origin<br>abitat<br>vogue              |    |    |
| 07P450170            | 07P440170            | 165-169                    | origin<br>abitat<br>vogue              |    |    |
| 07P450180            | 07P440180            | 175-179                    | origin<br>abitat<br>vogue              |    |    |

### installazioni

in nicchia    niche  
PL-PSC

ad angolo    corner  
PL-PSC+PL-F

ad angolo    corner  
PL-PSC+PL-FA

a tre lati    three sides  
PL-PSC+PL-F+PL-FA

### informazioni

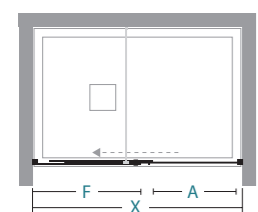

apertura scorrevole  
sliding door

|         | X  | A   | F |  |  |  |  |   |    |
|---------|----|-----|---|--|--|--|--|---|----|
| 95-99   | 41 | 48  |   |  |  |  |  | 2 | 45 |
| 105-109 | 41 | 58  |   |  |  |  |  | 2 | 48 |
| 115-119 | 51 | 58  |   |  |  |  |  | 2 | 53 |
| 125-129 | 51 | 68  |   |  |  |  |  | 2 | 56 |
| 135-139 | 61 | 68  |   |  |  |  |  | 2 | 61 |
| 145-149 | 61 | 78  |   |  |  |  |  | 2 | 64 |
| 155-159 | 66 | 83  |   |  |  |  |  | 2 | 68 |
| 165-169 | 66 | 93  |   |  |  |  |  | 2 | 72 |
| 175-179 | 66 | 103 |   |  |  |  |  | 2 | 74 |

X lunghezza parete doccia\ shower wall length  
A spazio d'entrata\ entrance space  
F lunghezza lato fisso\ fixed side length

| 05                  | 11    | 12     | 16                                 | 24    | 25    | 26   | 27   | 28         | 29   | 30          | 31          | 32       | 34         |
|---------------------|-------|--------|------------------------------------|-------|-------|------|--|------------|------|-------------|-------------|----------|------------|
| acrilico satin      | flack | reflex | satinato                           | nigol | flute | wave | alon   | fumè brown | fumè | trasparente | extrachiaro | cincillà | stampato C |
| origin              |       |        | abitat                             |       |       |      | vogue  |            |      |             |             |          |            |
| 59 Nero / 60 Bianco |       |        | 27 Tcrom® / 21 Tinox® / 22 Tbronz® |       |       |      | 61 Orosatinato / 62 Ororosa / 63 Cromonero / 64 Franciacorta / 65 Rame / 66 Brownie / Colori |            |      |             |             |          |            |

**Misure speciali L / H**
**Special sizes L / H**

| Codice SX<br>LH Code | Codice DX<br>RH Code | su misura<br>bespoke | Finiture profili<br>Profiles finishing | 30 | 16 | 27 | 12 |
|----------------------|----------------------|----------------------|--|----|----|----|----|
| 07P459001            | 07P449001            | 95 < L < 120         | origin<br>abibat<br>vogue              |    |    |    |    |
| 07P459001            | 07P449001            | 121 < L < 140        | origin<br>abibat<br>vogue              |    |    |    |    |
| 07P459001            | 07P449001            | 141 < L < 160        | origin<br>abibat<br>vogue              |    |    |    |    |
| 07P459001            | 07P449001            | 161 < L < 180        | origin<br>abibat<br>vogue              |    |    |    |    |
| 07P459001            | 07P449001            | 181 < L < 200        | origin<br>abibat<br>vogue              |    |    |    |    |
| 07P459001            | 07P449001            | 201 < L < 220        | origin<br>abibat<br>vogue              |    |    |    |    |
| 07P459001            | 07P449001            | 221 < L < 240        | origin<br>abibat<br>vogue              |    |    |    |    |

**attenzione**

Il prezzo della H speciale va trovato nella tabella **Misure speciali L / H** in base alla L della parete doccia

Special price for H is to be found in **Special sizes L / H** as per L needed size

**warning**

Optical e Terra - decografia per: vetro Trasparente, Misure standard e speciali, max L 135 cm

Optical and Terra - decoprinting for: glass Trasparente, Standard and Special sizes, max L 135 cm

Vetro temperato di sicurezza spessore 8 mm per la porta e spessore 6 mm per il fisso

Tempered glass 8 mm thick for the door and 6 mm for fixed part

Incluso: tirante di rinforzo lineare nei modelli da L 160 cm. Foro di fissaggio già predisposto sul binario

Included: linear bar to wall for 160 cm L. Standard fixing hole on the bar

Profilo tenuta acqua alto per installazioni a pavimento, per piatto doccia installato a filo pavimento o senza bordi

High sealed profile for floor installation and ultra flat shower tray

Approfondimenti  
Insights



Indice  
Index 3

Legenda simboli  
Icons legend 11

Profili - Vetri  
Profiles - Glasses 21

Ricambi  
Spare parts 406

Profili speciali  
Special profiles 434

Schede rilievo misure  
Measurement form 444

Misure speciali  
Special size

Disponibilità  
Availability

H max 210 cm  
L min 95 cm  
L max 240 cm

■ STOCK Tcrom®

**supplementi**
**supplements**

Profilo magnetico di chiusura  
Magnetic closure profile

Decografia  
Decoprinting

Sigillante SPARTAN®  
Sealant SPARTAN®

€ 37P061293

per codice  
for code

€ 36B010010

05 11 12 16 24 25 26 27 28 29 30 31 32 34  
 acrilico satin flack reflex satinato nigol flute wave aion fumè brown fumè trasparente extrachiaro cincillà stampato C

origin abibat vogue  
 59 Nero / 60 Bianco 27 Tcrom® / 21 Tinox® / 22 Tbronze® 61 Orosatinato / 62 Ororosa / 63 Cromonero / 64 Franciacorta / 65 Rame / 66 Brownie / Colori

# Pluma Evo

Parete doccia fissa di profondità  
Fixed panel



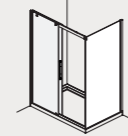

SX  
LH

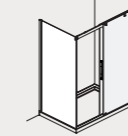

DX  
RH

incluso      included

disponibile      available

### installazioni

ad angolo      corner  
PL-F+PL-PSC



### informazioni

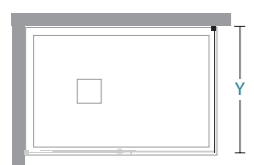

Y      lunghezza parete doccia\ shower wall length

### installations

### informations

| Y     |  |  |  |  |  |  |   |    |
|-------|--|--|--|--|--|--|---|----|
| 67-69 |  |  |  |  |  |  | 1 | 24 |
| 72-74 |  |  |  |  |  |  | 1 | 26 |
| 77-79 |  |  |  |  |  |  | 1 | 28 |
| 82-84 |  |  |  |  |  |  | 1 | 30 |
| 87-89 |  |  |  |  |  |  | 1 | 32 |

# PL-F

## INSTALLAZIONE AD ANGOLO CORNER INSTALLATION

### Misure standard

### Standard sizes

| Codice SX<br>LH Code | Codice DX<br>RH Code | estensibilità<br>extension | Finiture profili<br>Profiles finishing | 30 | 16 | 29 | 28 | 12 |
|----------------------|----------------------|----------------------------|--|----|----|----|----|----|
| 07F450070            | 07F460070            | 67-69                      | origin<br>abitat<br>vogue              |    |    |    |    |    |
| 07F450075            | 07F460075            | 72-74                      | origin<br>abitat<br>vogue              |    |    |    |    |    |
| 07F450080            | 07F460080            | 77-79                      | origin<br>abitat<br>vogue              |    |    |    |    |    |
| 07F450085            | 07F460085            | 82-84                      | origin<br>abitat<br>vogue              |    |    |    |    |    |
| 07F450090            | 07F460090            | 87-89                      | origin<br>abitat<br>vogue              |    |    |    |    |    |

### Misure speciali L / H

### Special sizes L / H

| Codice SX<br>LH Code | Codice DX<br>RH Code | su misura<br>bespoke | Finiture profili<br>Profiles finishing | 30 | 16 | 29 | 28 | 24 | 27 | 12 |
|----------------------|----------------------|----------------------|--|----|----|----|----|----|----|----|
| 07F459001            | 07F469001            | 12 < L < 60          | origin<br>abitat<br>vogue              |    |    |    |    |    |    |    |
| 07F459001            | 07F469001            | 61 < L < 80          | origin<br>abitat<br>vogue              |    |    |    |    |    |    |    |
| 07F459001            | 07F469001            | 81 < L < 100         | origin<br>abitat<br>vogue              |    |    |    |    |    |    |    |
| 07F459001            | 07F469001            | 101 < L < 120        | origin<br>abitat<br>vogue              |    |    |    |    |    |    |    |

### attenzione

Il prezzo della H speciale va trovato nella tabella Misure speciali L / H in base alla L della parete doccia

Special price for H is to be found in Special sizes L / H as per L needed size

### Misure speciali Special size

|   |     |        |
|---|-----|--------|
| H | max | 210 cm |
| L | min | 12 cm  |
| L | max | 120 cm |

### warning

Optical e Terra - decografia per: vetro Trasparente, Misure standard e speciali, max L 135 cm

Optical and Terra - decoprinting for: glass Trasparente, Standard and Special sizes, max L 135 cm

### Disponibilità Availability

STOCK Tcrom®

Specificare se installato a pavimento

Specify any floor installation

### supplementi

Decografia  
Decoprinting

€

### supplements

Sigillante SPARTAN®  
Sealant SPARTAN®

€

per codice  
for code      36B010010

|                |       |        |          |       |       |      |      |            |      |             |              |          |            |
|----------------|-------|--------|----------|-------|-------|------|------|------------|------|-------------|--------------|----------|------------|
| 05             | 11    | 12     | 16       | 24    | 25    | 26   | 27   | 28         | 29   | 30          | 31           | 32       | 34         |
| acrilico satin | flack | reflex | satinato | nigol | flute | wave | alon | fumè brown | fumè | trasparente | extrachiario | cincillà | stampato C |

| origin              | abitat                             | vogue  |
|---------------------|------------------------------------|--|
| 59 Nero / 60 Bianco | 27 Tcrom® / 21 Tinox® / 22 Tbronz® | 61 Orosatinato / 62 Ororosa / 63 Cromonero / 64 Franciacorta / 65 Rame / 66 Brownie / Colori |

### Approfondimenti Insights



|   |     |
|---|-----|
| Indice<br>Index                           | 3   |
| Legenda simboli<br>Icons legend           | 11  |
| Profili - Vetri<br>Profiles - Glasses     | 21  |
| Ricambi<br>Spare parts                    | 406 |
| Profili speciali<br>Special profiles      | 434 |
| Schede rilievo misure<br>Measurement form | 444 |



incluso included

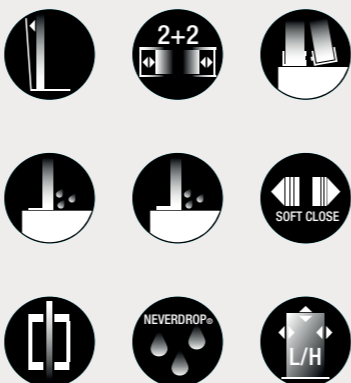

disponibile available



### installazioni

in nicchia niche  
PL-PSC2

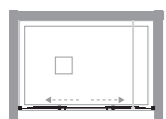

### installations

ad angolo corner  
PL-PSC2+PL-FA

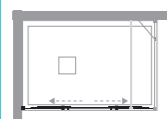

a tre lati three sides  
PL-PSC2+2xPL-FA

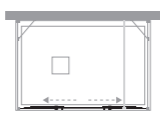

### informazioni

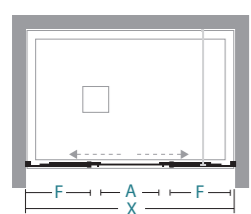

### informations

apertura scorrevole  
sliding door

| H       | X  | A  | F | nr | kg max |
|---------|----|----|---|----|--------|
| 136-140 | 52 | 36 |   | 2  | 59     |
| 146-150 | 52 | 41 |   | 2  | 62     |
| 156-160 | 66 | 39 |   | 2  | 68     |
| 166-170 | 66 | 44 |   | 2  | 71     |
| 176-180 | 66 | 49 |   | 2  | 74     |

**X** lunghezza parete doccia\ shower wall length  
**A** spazio d'entrata\ entrance space  
**F** lunghezza lato fisso\ fixed side length

### Misure standard

| Codice Code | estensibilità extension | Finiture profili Profiles finishing | 30 | 12 |
|-------------|-------------------------|-------------------------------------|----|----|
| 07P460140   | 136-140                 | origin<br>abitat<br>vogue           |    |    |
| 07P460150   | 146-150                 | origin<br>abitat<br>vogue           |    |    |
| 07P460160   | 156-160                 | origin<br>abitat<br>vogue           |    |    |
| 07P460170   | 166-170                 | origin<br>abitat<br>vogue           |    |    |
| 07P460180   | 176-180                 | origin<br>abitat<br>vogue           |    |    |

### Misure speciali L / H

| Codice Code | su misura bespoke | Finiture profili Profiles finishing | 30 | 16 | 27 | 12 |
|-------------|-------------------|-------------------------------------|----|----|----|----|
| 07P469001   | 130 < L < 150     | origin<br>abitat<br>vogue           |    |    |    |    |
| 07P469001   | 151 < L < 170     | origin<br>abitat<br>vogue           |    |    |    |    |
| 07P469001   | 171 < L < 190     | origin<br>abitat<br>vogue           |    |    |    |    |
| 07P469001   | 191 < L < 200     | origin<br>abitat<br>vogue           |    |    |    |    |
| 07P469001   | 201 < L < 220     | origin<br>abitat<br>vogue           |    |    |    |    |

### Special sizes L / H

### attenzione

Il prezzo della H speciale va trovato nella tabella Misure speciali L / H in base alla L della parete doccia

Special price for H is to be found in Special sizes L / H as per L needed size

### warning

Optical e Terra - decografia per: vetro Trasparente, Misure standard e speciali, max L 135 cm

Optical and Terra - decoupling for: glass Trasparente, Standard and Special sizes, max L 135 cm

Vetro temperato di sicurezza spessore 8 mm per la porta e spessore 6 mm per il fisso

Tempered glass 8 mm thick for the door and 6 mm for fixed part

Incluso: tirante di rinforzo lineare nei modelli da L 160 cm. Foro di fissaggio già predisposto sul binario

Included: linear bar to wall for 160 cm L. Standard fixing hole on the bar

### Misure speciali Special size

|   |     |        |
|---|-----|--------|
| H | max | 210 cm |
| L | min | 130 cm |
| L | max | 220 cm |

### supplementi

Profilo di compensazione 2 cm  
Extension profile 2 cm

Decografia  
Decouprinting

### supplements

Sigillante SPARTAN®  
Sealant SPARTAN®

37P019219

per codice  
for code

36B010010

| 05             | 11    | 12     | 16       | 24    | 25    | 26   | 27   | 28         | 29   | 30          | 31           | 32       | 34         |
|----------------|-------|--------|----------|-------|-------|------|------|------------|------|-------------|--------------|----------|------------|
| acrilico satin | flack | reflex | satinato | nigol | flute | wave | alou | fumè brown | fumè | trasparente | extrachiario | cincillà | stampato C |

| origin              | abitat                             | vogue  |
|---------------------|------------------------------------|--|
| 59 Nero / 60 Bianco | 27 Tcrom® / 21 Tinox® / 22 Tbronz® | 61 Orosatinato / 62 Ororosa / 63 Cromonero / 64 Franciacorta / 65 Rame / 66 Brownie / Colori |

### Approfondimenti Insights



|  |     |
|--|-----|
| Indice Index                           | 3   |
| Legenda simboli Icons legend           | 11  |
| Profili - Vetri Profiles - Glasses     | 21  |
| Ricambi Spare parts                    | 406 |
| Profili speciali Special profiles      | 434 |
| Schede rilievo misure Measurement form | 444 |

# Pluma Evo

Parete doccia con porta scorrevole per angolo  
Shower enclosure with sliding door for corner

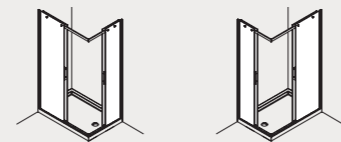

SX LH      DX RH



incluso      included

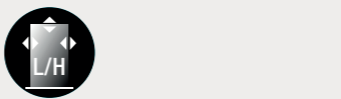

disponibile      available



## installazioni

ad angolo      corner  
PL-ASC+PL-ASC



## installations

a tre lati      three sides  
2xPL-ASC+PL-FA

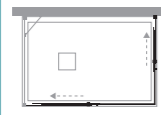

## informazioni

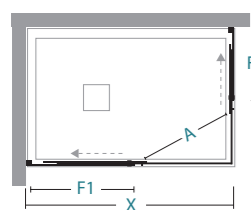

apertura scorrevole  
sliding door

X / Y      lunghezza parete doccia \ shower wall length  
A      spazio d'entrata \ entrance space  
F1 / F2      lunghezza lato fisso \ fixed side length

## informations

| X/Y     | 68-70 | 70-72 | 74-76 | 78-80 | 88-90 | 98-100 | 118-120 | F1/F2 |    |
|---------|-------|-------|-------|-------|-------|--------|---------|-------|----|
| 68-70   | A=38  |       |       |       |       |        |         | 31    | 30 |
| 70-72   | A=38  | A=38  |       |       |       |        |         | 33    | 31 |
| 74-76   | A=38  | A=38  | A=38  |       |       |        |         | 37    | 33 |
| 78-80   | A=41  | A=41  | A=41  | A=44  |       |        |         | 38    | 36 |
| 88-90   | A=44  | A=44  | A=44  | A=47  | A=50  |        |         | 43    | 39 |
| 98-100  | A=47  | A=47  | A=47  | A=50  | A=53  | A=56   |         | 49    | 42 |
| 118-120 | A=56  | A=56  | A=56  | A=58  | A=60  | A=63   | A=70    | 59    | 49 |

# PL-ASC

INSTALLAZIONE AD ANGOLO O A TRE LATI  
CORNER OR THREE SIDES INSTALLATION

## Misure standard

| Codice SX<br>LH Code | Codice DX<br>RH Code | estensibilità<br>extension | Finiture profili<br>Profiles finishing | 30 | 12 |
|----------------------|----------------------|----------------------------|--|----|----|
| 07A610070            | 07A600070            | 68-70                      | origin<br>abitat<br>vogue              |    |    |
| 07A610072            | 07A600072            | 70-72                      | origin<br>abitat<br>vogue              |    |    |
| 07A610076            | 07A600076            | 74-76                      | origin<br>abitat<br>vogue              |    |    |
| 07A610080            | 07A600080            | 78-80                      | origin<br>abitat<br>vogue              |    |    |
| 07A610090            | 07A600090            | 88-90                      | origin<br>abitat<br>vogue              |    |    |
| 07A610100            | 07A600100            | 98-100                     | origin<br>abitat<br>vogue              |    |    |
| 07A610120            | 07A600120            | 118-120                    | origin<br>abitat<br>vogue              |    |    |

## Standard sizes

## Misure speciali L / H

| Codice SX<br>LH Code | Codice DX<br>RH Code | su misura<br>bespoke | Finiture profili<br>Profiles finishing | 30 | 16 | 27 | 12 |
|----------------------|----------------------|----------------------|--|----|----|----|----|
| 07A619001            | 07A609001            | 68 < L < 80          | origin<br>abitat<br>vogue              |    |    |    |    |
| 07A619001            | 07A609001            | 81 < L < 100         | origin<br>abitat<br>vogue              |    |    |    |    |
| 07A619001            | 07A609001            | 101 < L < 120        | origin<br>abitat<br>vogue              |    |    |    |    |
| 07A619001            | 07A609001            | 121 < L < 140        | origin<br>abitat<br>vogue              |    |    |    |    |

## Special sizes L / H

## attenzione

Il prezzo della H speciale va trovato nella tabella Misure speciali L / H in base alla L della parete doccia

Special price for H is to be found in Special sizes L / H as per L needed size

## warning

Il prezzo è inteso per lato  
Prices are to be intended for one side

Optical e Terra - decografia per: vetro Trasparente, Misure standard e speciali, max L 135 cm  
Optical and Terra - decoprinting for: glass Trasparente, Standard and Special sizes, max L 135 cm

Vetro temperato di sicurezza spessore 8 mm per la porta e spessore 6 mm per il fisso  
Tempered glass 8 mm thick for the door and 6 mm for fixed part

Doppio collo dalla misura 78-80 in poi e per tutti gli speciali  
Double neck from size 78-80 onwards and for all specials

Approfondimenti  
Insights



|   |     |
|---|-----|
| Indice<br>Index                           | 3   |
| Legenda simboli<br>Icons legend           | 11  |
| Profili - Vetri<br>Profiles - Glasses     | 21  |
| Ricambi<br>Spare parts                    | 406 |
| Profili speciali<br>Special profiles      | 434 |
| Schede rilievo misure<br>Measurement form | 444 |

## Misure speciali Special size

|   |     |        |
|---|-----|--------|
| H | max | 210 cm |
| L | min | 68 cm  |
| L | max | 140 cm |

## supplementi

Profilo di compensazione 2 cm  
Extension profile 2 cm

Decografia  
Decoprinting

## supplements

Sigillante SPARTAN®  
Sealant SPARTAN®

37P019219

per codice  
for code

36B010010

|                         |        |          |       |       |      |      |            |      |             |              |          |            |    |
|-------------------------|--------|----------|-------|-------|------|------|------------|------|-------------|--------------|----------|------------|----|
| 05                      | 11     | 12       | 16    | 24    | 25   | 26   | 27         | 28   | 29          | 30           | 31       | 32         | 34 |
| acrilico satin<br>flack | reflex | satinato | nigol | flute | wave | alon | fumè brown | fumè | trasparente | extrachiario | cincillà | stampato C |    |

origin      abitat      vogue  
59 Nero / 60 Bianco      27 Tcrom® / 21 Tinox® / 22 Tbronze®      61 Orosatinato / 62 Ororosa / 63 Cromonero / 64 Franciacorta / 65 Rame / 66 Brownie / Colori

# Pluma Evo

Parete doccia fissa aggiuntiva di profondità  
Additional fixed panel

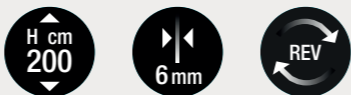
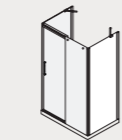

incluso included



disponibile available



installazioni

ad angolo corner  
PL-FA+PL-PSC

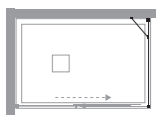

installations

a tre lati three sides  
PL-FA+2xPL-ASC

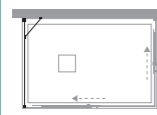

a tre lati three sides  
PL-FA+PL-PSC+PL-F

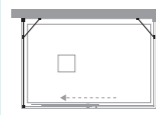

a tre lati three sides  
2xPL-FA+PL-PSC2

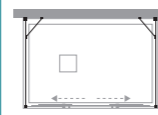

informazioni

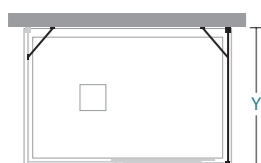

Y lunghezza parete doccia \ shower wall length

informations

| Y     |  |  |  |  |  |   |  |  |  |    |
|-------|--|--|--|--|--|---|--|--|--|----|
| 68-70 |  |  |  |  |  | 1 |  |  |  | 24 |
| 72-74 |  |  |  |  |  | 1 |  |  |  | 25 |
| 76-78 |  |  |  |  |  | 1 |  |  |  | 27 |
| 78-80 |  |  |  |  |  | 1 |  |  |  | 27 |
| 80-82 |  |  |  |  |  | 1 |  |  |  | 28 |
| 88-90 |  |  |  |  |  | 1 |  |  |  | 31 |

## PL-FA

INSTALLAZIONE AD ANGOLO O A TRE LATI  
CORNER OR THREE SIDES INSTALLATION

Misure standard

| Codice Code | estensibilità extension | Finiture profili Profiles finishing | 30 | 16 | 29 | 28 | 12 |
|-------------|-------------------------|-------------------------------------|----|----|----|----|----|
| 07F050068   | 68-70                   | origin<br>abitat<br>vogue           |    |    |    |    |    |
| 07F050072   | 72-74                   | origin<br>abitat<br>vogue           |    |    |    |    |    |
| 07F050076   | 76-78                   | origin<br>abitat<br>vogue           |    |    |    |    |    |
| 07F050078   | 78-80                   | origin<br>abitat<br>vogue           |    |    |    |    |    |
| 07F050080   | 80-82                   | origin<br>abitat<br>vogue           |    |    |    |    |    |
| 07F050088   | 88-90                   | origin<br>abitat<br>vogue           |    |    |    |    |    |

Standard sizes

Misure speciali L / H

| Codice Code | su misura bespoke | Finiture profili Profiles finishing | 30 | 16 | 29 | 28 | 24 | 27 | 12 |
|-------------|-------------------|-------------------------------------|----|----|----|----|----|----|----|
| 07F059001   | 16 < L < 60       | origin<br>abitat<br>vogue           |    |    |    |    |    |    |    |
| 07F059001   | 61 < L < 80       | origin<br>abitat<br>vogue           |    |    |    |    |    |    |    |
| 07F059001   | 81 < L < 100      | origin<br>abitat<br>vogue           |    |    |    |    |    |    |    |
| 07F059001   | 101 < L < 120     | origin<br>abitat<br>vogue           |    |    |    |    |    |    |    |

Special sizes L / H

attenzione

Il prezzo della H speciale va trovato nella tabella Misure speciali L / H in base alla L della parete doccia

Special price for H is to be found in Special sizes L / H as per L needed size

warning

Optical e Terra - decografia per: vetro Trasparente, Misure standard e speciali, max L 135 cm

Optical and Terra - decoprinting for: glass Trasparente, Standard and Special sizes, max L 135 cm

Incluso: doppio supporto di rinforzo regolabile e snodato

Included: double adjustable, articulated supporting bar

Specificare se installato a pavimento

Specify any floor installation

Misure speciali  
Special size

|       |        |
|-------|--------|
| H max | 210 cm |
| L min | 16 cm  |
| L max | 120 cm |

supplementi

Profilo di compensazione 2 cm  
Extension profile 2 cm

Decografia  
Decoprinting

supplements

Sigillante SPARTAN®  
Sealant SPARTAN®

37P019219 per codice  
for code

|                |       |        |          |       |       |      |      |            |      |             |             |          |            |
|----------------|-------|--------|----------|-------|-------|------|------|------------|------|-------------|-------------|----------|------------|
| 05             | 11    | 12     | 16       | 24    | 25    | 26   | 27   | 28         | 29   | 30          | 31          | 32       | 34         |
| acrilico satin | flack | reflex | satinato | nigol | flute | wave | alon | fumè brown | fumè | trasparente | extrachiaro | cincillà | stampato C |

|                     |                                     |  |  |  |       |  |  |  |  |  |  |  |  |
|---------------------|-------------------------------------|--|--|--|-------|--|--|--|--|--|--|--|--|
| origin              | abitat                              |  |  |  | vogue |  |  |  |  |  |  |  |  |
| 59 Nero / 60 Bianco | 27 Tcrom® / 21 Tinox® / 22 Tbronze® | 61 Orosatinato / 62 Ororosa / 63 Cromonero / 64 Franciacorta / 65 Rame / 66 Brownie / Colori |  |  |       |  |  |  |  |  |  |  |  |

Approfondimenti  
Insights



|   |     |
|---|-----|
| Indice<br>Index                           | 3   |
| Legenda simboli<br>Icons legend           | 11  |
| Profili - Vetri<br>Profiles - Glasses     | 21  |
| Ricambi<br>Spare parts                    | 406 |
| Profili speciali<br>Special profiles      | 434 |
| Schede rilievo misure<br>Measurement form | 444 |

## CON PROFILO VERTICALE WITH VERTICAL PROFILE



Porta scorrevole installazione in nicchia  
profilo Orosatinato / vetro Trasparente  
Piatto doccia ARTURO

Sliding door niche installation  
Orosatinato profile / Transparent glass  
Shower tray ARTURO

## GAIA

Il binario di scorrimento sottile, i profili lineari e lo sgancio inferiore dell'anta per una migliore pulizia sottolineano la moderna versatilità di questa serie. Linea pratica e funzionale dove qualità e design si fondono, per dar vita a un sistema accurato ed eclettico. I modelli sono proposti in diverse finiture. L'aspetto moderno e la facilità nel montaggio rendono questi modelli molto apprezzati

A shower wall that strikes for its modern versatility: a slim sliding system, slim linear profiles and a the quick release system. A practical and functional line where quality and design meet to create a precise and eclectic system. The models come in many different finishes. The modern appearance and ease of installation make these models highly appreciated



01



02



03

04  
05

**01** giunto per angolo con fissaggio a 45° | **02** fermo dell'anta con fine corsa ammortizzato e registrabile | **03** guida inferiore con sistema per sgancio facilitato dell'anta | **04** maniglia esterna/pomoli interni per GA-ASC | **05** doppia maniglia esterna/interna, interasse 32 cm |

**01** corner connection with 45° fixing | **02** adjustable shock absorber | **03** floor rail with quick release system | **04** external handle / internal knob for GA-ASC | **05** double external/internal handle, interaxe 32 cm |



### CARATTERISTICHE FEATURES

- H cm 200** ALTEZZA PARETI DOCCIA  
SHOWER DOOR HEIGHT
- 6 mm** SPESSORE LASTRA  
GLASS DEPTH
- REV** NON REVERSIBILE  
NON-REVERSIBLE

### INFO TECNICHE TECHNICAL INFORMATION

- REGOLAZIONE FUORI SQUADRO**  
OFF-SQUARE REGULATION
- EST cm** ESTENSIBILITÀ 2/4  
EXSTENSIBILITY 2/4
- SGANCIO RAPIDO**  
QUICK-RELEASE
- PROFILO TENUTA ACQUA ALTO**  
HIGH SEAL WATER PROFILE
- FINE CORSA AMMORTIZZATO**  
CUSHIONED END OF STROKE
- 2 cm** PROFILO DI COMPENSAZIONE  
COMPENSATOR PROFILE
- MANIGLIA ESTERNA/POMOLO INTERNO**  
EXTERNAL HANDLE/INTERNAL POMMEL
- MANIGLIE ESTERNA/INTERNA**  
EXTERNAL/INTERNAL HANDLES
- NEVERDROP®** TRATTAMENTO NEVERDROP®  
NEVERDROP® TREATMENT
- L/H** MISURE SPECIALI  
SPECIAL SIZES
- DECOGRAFIA**  
DECOPRINTING

### Finiture profili

#### ORIGIN

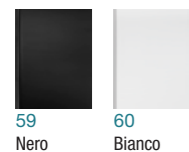

### Profiles finishing

#### ABITAT



#### VOGUE

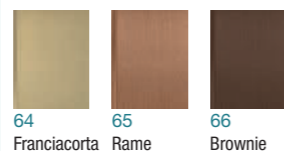
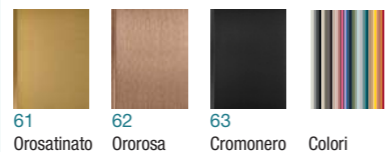

### Vetri

### Glasses



### in nicchia

GA-PSC

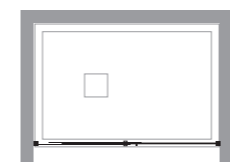

GA-PSC2

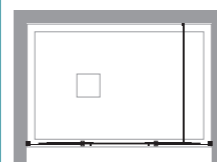

### niche

### ad angolo

GA-PSC+GA-F

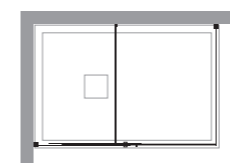

GA-PSC+GA-FA

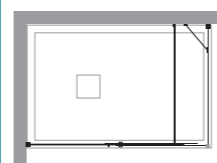

### corner

GA-PSC2+GA-FA

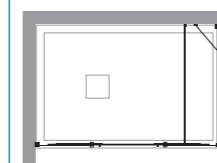

2xGA-ASC

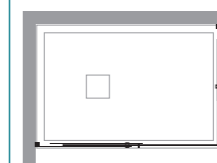

### a tre lati

GA-PSC+GA-F+GA-F



GA-PSC2+2xGA-FA

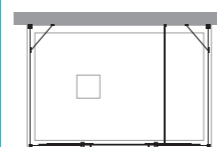

### three sides

2xGA-ASC+GA-FA

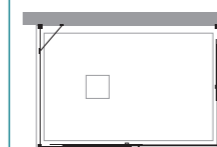

### profili

### profiles

per/for **GA: PSC-PSC2-ASC-F-FA**

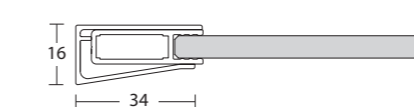

profilo a muro 966 + schienale 261

wall profile 966 + vertical profile 261

per/for **GA-PSC**

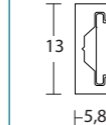

chiusura con magnete 1293

magnetic closing 1293

### importante

### important

ordini per pareti doccia speciali senza relativo disegno  
**NON** vengono prodotti

orders for special shower walls without related design are  
**NOT** produced

per installazioni a tre lati richiedere fattibilità. Alcune  
configurazioni necessitano di elementi aggiuntivi

contact TDA technical office for three side installation. Some  
configurations require additional elements



SX  
LH

DX  
RH

H cm  
200

6 mm

REFV

incluso      included

disponibile      available

| Misure standard      |                      |                            | Standard sizes                         |    |    |    |    |    |
|----------------------|----------------------|----------------------------|--|----|----|----|----|----|
| Codice SX<br>LH Code | Codice DX<br>RH Code | estensibilità<br>extension | Finiture profili<br>Profiles finishing | 30 | 16 | 29 | 28 | 12 |
| 07P350100            | 07P340100            | 95-99                      | origin<br>abitat<br>vogue              |    |    |    |    |    |
| 07P350110            | 07P340110            | 105-109                    | origin<br>abitat<br>vogue              |    |    |    |    |    |
| 07P350120            | 07P340120            | 115-119                    | origin<br>abitat<br>vogue              |    |    |    |    |    |
| 07P350130            | 07P340130            | 125-129                    | origin<br>abitat<br>vogue              |    |    |    |    |    |
| 07P350140            | 07P340140            | 135-139                    | origin<br>abitat<br>vogue              |    |    |    |    |    |
| 07P350150            | 07P340150            | 145-149                    | origin<br>abitat<br>vogue              |    |    |    |    |    |
| 07P350160            | 07P340160            | 155-159                    | origin<br>abitat<br>vogue              |    |    |    |    |    |
| 07P350170            | 07P340170            | 165-169                    | origin<br>abitat<br>vogue              |    |    |    |    |    |
| 07P350180            | 07P340180            | 175-179                    | origin<br>abitat<br>vogue              |    |    |    |    |    |

installazioni

in nicchia    niche  
GA-PSC

ad angolo    corner  
GA-PSC+GA-F

ad angolo    corner  
GA-PSC+GA-FA

a tre lati    three sides  
GA-PSC+GA-F+GA-FA

informazioni

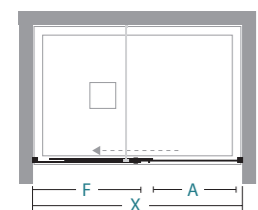

apertura scorrevole  
sliding door

|  | X       | A  | F   |  |  |  |  |  |   |    |
|--|---------|----|-----|--|--|--|--|--|---|----|
|  | 95-99   | 41 | 48  |  |  |  |  |  |   |    |
|  | 105-109 | 41 | 58  |  |  |  |  |  | 2 | 41 |
|  | 115-119 | 51 | 58  |  |  |  |  |  | 2 | 45 |
|  | 125-129 | 51 | 68  |  |  |  |  |  | 2 | 48 |
|  | 135-139 | 61 | 68  |  |  |  |  |  | 2 | 53 |
|  | 145-149 | 61 | 78  |  |  |  |  |  | 2 | 56 |
|  | 155-159 | 66 | 83  |  |  |  |  |  | 2 | 60 |
|  | 165-169 | 66 | 93  |  |  |  |  |  | 2 | 63 |
|  | 175-179 | 66 | 103 |  |  |  |  |  | 2 | 67 |

X lunghezza parete doccia\ shower wall length  
A spazio d'entrata\ entrance space  
F lunghezza lato fisso\ fixed side length

| 05                  | 11    | 12     | 16                                 | 24    | 25    | 26   | 27   | 28         | 29   | 30          | 31           | 32       | 34         |
|---------------------|-------|--------|------------------------------------|-------|-------|------|--|------------|------|-------------|--------------|----------|------------|
| acrilico satin      | flack | reflex | satinato                           | nigol | flute | wave | alon   | fumè brown | fumè | trasparente | extrachiario | cincillà | stampato C |
| origin              |       |        | abitat                             |       |       |      | vogue  |            |      |             |              |          |            |
| 59 Nero / 60 Bianco |       |        | 27 Tcrom® / 21 Tinox® / 22 Tbronz® |       |       |      | 61 Orosatinato / 62 Ororosa / 63 Cromonero / 64 Franciacorta / 65 Rame / 66 Brownie / Colori |            |      |             |              |          |            |

**Misure speciali L / H**
**Special sizes L / H**

| Codice SX<br>LH Code | Codice DX<br>RH Code | su misura<br>bespoke | Finiture profili<br>Profiles finishing | 30 | 16 | 29 | 28 | 24 | 27 | 12 |
|----------------------|----------------------|----------------------|--|----|----|----|----|----|----|----|
| 07P359001            | 07P349001            | 91 < L < 120         | origin                                 |    |    |    |    |    |    |    |
|                      |                      |                      | abitat                                 |    |    |    |    |    |    |    |
|                      |                      |                      | vogue                                  |    |    |    |    |    |    |    |
| 07P359001            | 07P349001            | 121 < L < 140        | origin                                 |    |    |    |    |    |    |    |
|                      |                      |                      | abitat                                 |    |    |    |    |    |    |    |
|                      |                      |                      | vogue                                  |    |    |    |    |    |    |    |
| 07P359001            | 07P349001            | 141 < L < 160        | origin                                 |    |    |    |    |    |    |    |
|                      |                      |                      | abitat                                 |    |    |    |    |    |    |    |
|                      |                      |                      | vogue                                  |    |    |    |    |    |    |    |
| 07P359001            | 07P349001            | 161 < L < 180        | origin                                 |    |    |    |    |    |    |    |
|                      |                      |                      | abitat                                 |    |    |    |    |    |    |    |
|                      |                      |                      | vogue                                  |    |    |    |    |    |    |    |
| 07P359001            | 07P349001            | 181 < L < 200        | origin                                 |    |    |    |    |    |    |    |
|                      |                      |                      | abitat                                 |    |    |    |    |    |    |    |
|                      |                      |                      | vogue                                  |    |    |    |    |    |    |    |
| 07P359001            | 07P349001            | 201 < L < 220        | origin                                 |    |    |    |    |    |    |    |
|                      |                      |                      | abitat                                 |    |    |    |    |    |    |    |
|                      |                      |                      | vogue                                  |    |    |    |    |    |    |    |
| 07P359001            | 07P349001            | 221 < L < 240        | origin                                 |    |    |    |    |    |    |    |
|                      |                      |                      | abitat                                 |    |    |    |    |    |    |    |
|                      |                      |                      | vogue                                  |    |    |    |    |    |    |    |

**attenzione**

Il prezzo della H speciale va trovato nella tabella **Misure speciali L / H** in base alla L della parete doccia

Special price for H is to be found in **Special sizes L / H** as per L needed size

**warning**

Optical e Terra - decografia per: vetro Trasparente e Fumè, Misure standard e speciali, max L 135 cm

Optical and Terra - decoprinting for: glass Trasparente and Fumè, Standard and Special sizes, max L 135 cm

Incluso: tirante di rinforzo lineare nei modelli da L 160 cm

Included: linear bar to wall for L 160 cm

Il binario di scorrimento non copre la larghezza da muro a muro nelle dimensioni L 110, 130 150, 170 e 180 cm

Sliding rail does not fit niches L 110, 130, 150, 170 and 180 cm

**Approfondimenti**  
 Insights

|   |     |
|---|-----|
| Indice<br>Index                           | 3   |
| Legenda simboli<br>Icons legend           | 11  |
| Profili - Vetri<br>Profiles - Glasses     | 21  |
| Ricambi<br>Spare parts                    | 406 |
| Profili speciali<br>Special profiles      | 434 |
| Schede rilievo misure<br>Measurement form | 444 |

| Misure speciali<br>Special size             | Disponibilità<br>Availability |
|---|-------------------------------|
| H max 210 cm<br>L min 91 cm<br>L max 240 cm | ■ STOCK Tcrom®                |

**supplementi**
**supplements**

| Profilo tenuta acqua basso<br>Low sealed profile | Profilo magnetico di chiusura<br>Magnetic closure profile | Decografia<br>Decoprinting | Sigillante SPARTAN®<br>Sealant SPARTAN® |
|--|---|----------------------------|---|
| € 37R019220                                      | € 37P061293   | per codice<br>for code     | € 36B010010                             |

|                      |             |              |                |             |             |            |            |                  |            |                   |                    |                |                  |
|----------------------|-------------|--------------|----------------|-------------|-------------|------------|------------|------------------|------------|-------------------|--------------------|----------------|------------------|
| 05<br>acrilico satin | 11<br>flack | 12<br>reflex | 16<br>satinato | 24<br>nigol | 25<br>flute | 26<br>wave | 27<br>alou | 28<br>fumè brown | 29<br>fumè | 30<br>trasparente | 31<br>extrachiario | 32<br>cincillà | 34<br>stampato C |
|----------------------|-------------|--------------|----------------|-------------|-------------|------------|------------|------------------|------------|-------------------|--------------------|----------------|------------------|

|                     |                                     |  |
|---------------------|-------------------------------------|--|
| origin              | abitat                              | vogue  |
| 59 Nero / 60 Bianco | 27 Tcrom® / 21 Tinox® / 22 Tbronzo® | 61 Orosatinato / 62 Ororosa / 63 Cromonero / 64 Franciacorta / 65 Rame / 66 Brownie / Colori |



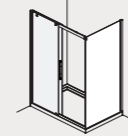

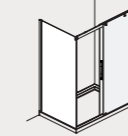

SX  
LH





DX  
RH

incluso

included

disponibile



available



installazioni

ad angolo corner  
GA-F+GA-PSC



informazioni



Y lunghezza parete doccia\ shower wall length

installations

informations

| Y     |  |  |  |  |  |  |  |   |    |
|-------|--|--|--|--|--|--|--|---|----|
| 67-69 |  |  |  |  |  |  |  | 1 | 24 |
| 72-74 |  |  |  |  |  |  |  | 1 | 26 |
| 77-79 |  |  |  |  |  |  |  | 1 | 28 |
| 82-84 |  |  |  |  |  |  |  | 1 | 30 |
| 87-89 |  |  |  |  |  |  |  | 1 | 32 |

Misure standard

Standard sizes

| Codice SX<br>LH Code | Codice DX<br>RH Code | estensibilità<br>extension | Finiture profili<br>Profiles finishing | 30 | 16 | 29 | 28 | 12 |
|----------------------|----------------------|----------------------------|--|----|----|----|----|----|
| 07F450070            | 07F460070            | 67-69                      | origin<br>abitat<br>vogue              |    |    |    |    |    |
| 07F450075            | 07F460075            | 72-74                      | origin<br>abitat<br>vogue              |    |    |    |    |    |
| 07F450080            | 07F460080            | 77-79                      | origin<br>abitat<br>vogue              |    |    |    |    |    |
| 07F450085            | 07F460085            | 82-84                      | origin<br>abitat<br>vogue              |    |    |    |    |    |
| 07F450090            | 07F460090            | 87-89                      | origin<br>abitat<br>vogue              |    |    |    |    |    |

Misure speciali L / H

Special sizes L / H

| Codice SX<br>LH Code | Codice DX<br>RH Code | su misura<br>bespoke | Finiture profili<br>Profiles finishing | 30 | 16 | 29 | 28 | 24 | 27 | 12 |
|----------------------|----------------------|----------------------|--|----|----|----|----|----|----|----|
| 07F459001            | 07F469001            | 12 < L < 60          | origin<br>abitat<br>vogue              |    |    |    |    |    |    |    |
| 07F459001            | 07F469001            | 61 < L < 80          | origin<br>abitat<br>vogue              |    |    |    |    |    |    |    |
| 07F459001            | 07F469001            | 81 < L < 100         | origin<br>abitat<br>vogue              |    |    |    |    |    |    |    |
| 07F459001            | 07F469001            | 101 < L < 120        | origin<br>abitat<br>vogue              |    |    |    |    |    |    |    |

attenzione

Il prezzo della H speciale va trovato nella tabella Misure speciali L / H in base alla L della parete doccia

Special price for H is to be found in Special sizes L / H as per L needed size

warning

Specificare se installato a pavimento

Specify any floor installation

Misure speciali  
Special size

|   |     |        |
|---|-----|--------|
| H | max | 210 cm |
| L | min | 12 cm  |
| L | max | 120 cm |

Disponibilità  
Availability

STOCK Tcrom®

supplementi

Decografia  
Decoprinting

Sigillante SPARTAN®  
Sealant SPARTAN®

per codice  
for code

36B010010

|                |       |        |          |       |       |      |      |            |      |             |              |          |            |
|----------------|-------|--------|----------|-------|-------|------|------|------------|------|-------------|--------------|----------|------------|
| 05             | 11    | 12     | 16       | 24    | 25    | 26   | 27   | 28         | 29   | 30          | 31           | 32       | 34         |
| acrilico satin | flack | reflex | satinato | nigol | flute | wave | alon | fumè brown | fumè | trasparente | extrachiario | cincillà | stampato C |

|                     |                                    |  |
|---------------------|------------------------------------|--|
| origin              | abitat                             | vogue  |
| 59 Nero / 60 Bianco | 27 Tcrom® / 21 Tinox® / 22 Tbronz® | 61 Orosatinato / 62 Ororosa / 63 Cromonero / 64 Franciacorta / 65 Rame / 66 Brownie / Colori |

Approfondimenti  
Insights



|   |     |
|---|-----|
| Indice<br>Index                           | 3   |
| Legenda simboli<br>Icons legend           | 11  |
| Profili - Vetri<br>Profiles - Glasses     | 21  |
| Ricambi<br>Spare parts                    | 406 |
| Profili speciali<br>Special profiles      | 434 |
| Schede rilievo misure<br>Measurement form | 444 |

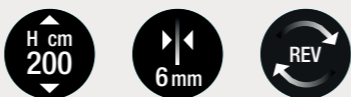

incluso included

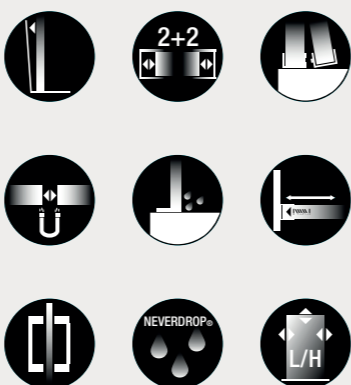

disponibile available



### installazioni

in nicchia niche  
GA-PSC2

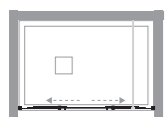

### installations

ad angolo corner  
GA-PSC2+GA-FA

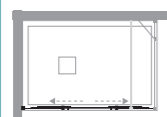

a tre lati three sides  
GA-PSC2+2xGA-FA

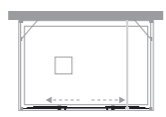

### informazioni

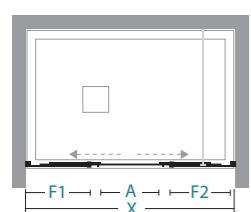

### informations

apertura scorrevole  
sliding door

| X       | A  | F1/F2 |  |  |  |  |  |   |    |
|---------|----|-------|--|--|--|--|--|---|----|
| 136-140 | 52 | 36    |  |  |  |  |  | 2 | 55 |
| 146-150 | 52 | 41    |  |  |  |  |  | 2 | 58 |
| 156-160 | 66 | 39    |  |  |  |  |  | 2 | 62 |
| 166-170 | 66 | 44    |  |  |  |  |  | 2 | 66 |
| 176-180 | 66 | 49    |  |  |  |  |  | 2 | 69 |

X lunghezza parete doccia\ shower wall length  
A spazio d'entrata\ entrance space  
F1 / F2 lunghezza lato fisso\ fixed side length

### Misure standard

| Codice Code | estensibilità extension | Finiture profili Profiles finishing | 30 | 16 | 29 | 28 | 12 |
|-------------|-------------------------|-------------------------------------|----|----|----|----|----|
| 07P360140   | 136-140                 | origin<br>abitat<br>vogue           |    |    |    |    |    |
| 07P360150   | 146-150                 | origin<br>abitat<br>vogue           |    |    |    |    |    |
| 07P360160   | 156-160                 | origin<br>abitat<br>vogue           |    |    |    |    |    |
| 07P360170   | 166-170                 | origin<br>abitat<br>vogue           |    |    |    |    |    |
| 07P360180   | 176-180                 | origin<br>abitat<br>vogue           |    |    |    |    |    |

### Standard sizes

### Misure speciali L / H

| Codice Code | su misura bespoke | Finiture profili Profiles finishing | 30 | 16 | 29 | 28 | 24 | 27 | 12 |
|-------------|-------------------|-------------------------------------|----|----|----|----|----|----|----|
| 07P369001   | 118 < L < 150     | origin<br>abitat<br>vogue           |    |    |    |    |    |    |    |
| 07P369001   | 151 < L < 170     | origin<br>abitat<br>vogue           |    |    |    |    |    |    |    |
| 07P369001   | 171 < L < 190     | origin<br>abitat<br>vogue           |    |    |    |    |    |    |    |
| 07P369001   | 191 < L < 200     | origin<br>abitat<br>vogue           |    |    |    |    |    |    |    |

### Special sizes L / H

### attenzione

Il prezzo della H speciale va trovato nella tabella Misure speciali L / H in base alla L della parete doccia

Special price for H is to be found in Special sizes L / H as per L needed size

### warning

Optical e Terra - decografia per: vetro Trasparente e Fumè, Misure standard e speciali, max L 135 cm

Optical and Terra - decoprinting for: glass Trasparente and Fumè, Standard and Special sizes, max L 135 cm

Incluso: tirante di rinforzo lineare nei modelli da L 160 cm

Included: linear bar to wall for L 160 cm

### Misure speciali

| H | max | 210 cm |
|---|-----|--------|
| L | min | 118 cm |
| L | max | 200 cm |

### supplementi

Profilo tenuta acqua basso  
Low sealed profile

Profilo di compensazione 2 cm  
Extension profile 2 cm

Decografia  
Decoprinting

Sigillante SPARTAN®  
Sealant SPARTAN®

37R019220

37P019219

per codice  
for code

36B010010

| 05             | 11    | 12     | 16       | 24    | 25    | 26   | 27   | 28         | 29   | 30          | 31           | 32       | 34         |
|----------------|-------|--------|----------|-------|-------|------|------|------------|------|-------------|--------------|----------|------------|
| acrilico satin | flack | reflex | satinato | nigol | flute | wave | alon | fumè brown | fumè | trasparente | extrachiario | cincillà | stampato C |

| origin              | abitat                             | vogue  |
|---------------------|------------------------------------|--|
| 59 Nero / 60 Bianco | 27 Tcrom® / 21 Tinox® / 22 Tbronz® | 61 Orosatinato / 62 Ororosa / 63 Cromonero / 64 Franciacorta / 65 Rame / 66 Brownie / Colori |

### Approfondimenti

Insights



|  |     |
|--|-----|
| Indice Index                           | 3   |
| Legenda simboli Icons legend           | 11  |
| Profili - Vetri Profiles - Glasses     | 21  |
| Ricambi Spare parts                    | 406 |
| Profili speciali Special profiles      | 434 |
| Schede rilievo misure Measurement form | 444 |

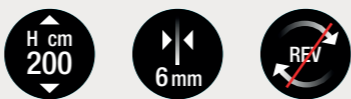
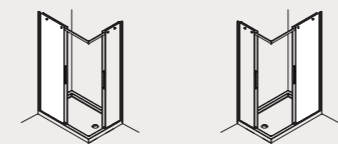

incluso included

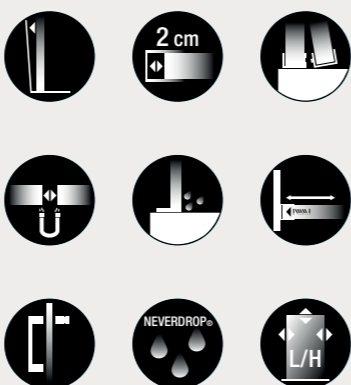

disponibile available



### installazioni

ad angolo corner  
GA-ASC+GA-ASC



### installations

a tre lati three sides  
2xGA-ASC+GA-FA

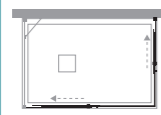

### informazioni

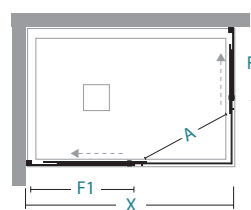

apertura scorrevole  
sliding door

X / Y lunghezza parete doccia \ shower wall length  
A spazio d'entrata \ entrance space  
F1 / F2 lunghezza lato fisso \ fixed side length

### informations

| X/Y     | 68-70  | 70-72  | 74-76  | 78-80  | 88-90 | 98-120 | F1/F2 |   |    |
|---------|--------|--------|--------|--------|-------|--------|-------|---|----|
| 68-70   | A=35   |        |        |        |       |        | 35    | 1 | 26 |
| 70-72   | A=35   | A=35   |        |        |       |        | 37    | 1 | 27 |
| 74-76   | A=35   | A=35   | A=35   |        |       |        | 41    | 1 | 29 |
| 78-80   | A=39   | A=39   | A=39   | A=42   |       |        | 40    | 2 | 31 |
| 88-90   | A=42,5 | A=42,5 | A=42,5 | A=45,5 | A=49  |        | 45    | 2 | 35 |
| 98-100  | A=42,5 | A=42,5 | A=42,5 | A=45,5 | A=49  | A=49   | 55    | 2 | 39 |
| 118-120 | A=42,5 | A=42,5 | A=42,5 | A=45,5 | A=49  | A=49   | 75    | 2 | 45 |

### Misure standard

| Codice SX<br>LH Code | Codice DX<br>RH Code | estensibilità<br>extension | Finiture profili<br>Profiles finishing | 30 | 16 | 29 | 28 | 12 |
|----------------------|----------------------|----------------------------|--|----|----|----|----|----|
| 07A430070            | 07A420070            | 68-70                      | origin<br>abitat<br>vogue              |    |    |    |    |    |
| 07A430072            | 07A420072            | 70-72                      | origin<br>abitat<br>vogue              |    |    |    |    |    |
| 07A430076            | 07A420076            | 74-76                      | origin<br>abitat<br>vogue              |    |    |    |    |    |
| 07A430080            | 07A420080            | 78-80                      | origin<br>abitat<br>vogue              |    |    |    |    |    |
| 07A430090            | 07A420090            | 88-90                      | origin<br>abitat<br>vogue              |    |    |    |    |    |
| 07A430100            | 07A420100            | 98-100                     | origin<br>abitat<br>vogue              |    |    |    |    |    |
| 07A430120            | 07A420120            | 118-120                    | origin<br>abitat<br>vogue              |    |    |    |    |    |

### Standard sizes

### Misure speciali L / H

| Codice SX<br>LH Code | Codice DX<br>RH Code | su misura<br>bespoke | Finiture profili<br>Profiles finishing | 30 | 16 | 29 | 28 | 24 | 27 | 12 |
|----------------------|----------------------|----------------------|--|----|----|----|----|----|----|----|
| 07A439001            | 07A429001            | 58 < L < 80          | origin<br>abitat<br>vogue              |    |    |    |    |    |    |    |
| 07A439001            | 07A429001            | 81 < L < 100         | origin<br>abitat<br>vogue              |    |    |    |    |    |    |    |
| 07A439001            | 07A429001            | 101 < L < 120        | origin<br>abitat<br>vogue              |    |    |    |    |    |    |    |
| 07A439001            | 07A429001            | 121 < L < 140        | origin<br>abitat<br>vogue              |    |    |    |    |    |    |    |

### Special sizes L / H

### attenzione

Il prezzo della H speciale va trovato nella tabella Misure speciali L / H in base alla L della parete doccia

Special price for H is to be found in Special sizes L / H as per L needed size

### warning

Il prezzo è inteso per lato

Prices are to be intended for one side

Optical e Terra - decografia per: vetro Trasparente e Fumè, Misure standard e speciali, max L 135 cm

Optical and Terra - decoprinting for: glass Trasparente and Fumè, Standard and Special sizes, max L 135 cm

### Misure speciali Special size

|   |     |        |
|---|-----|--------|
| H | max | 210 cm |
| L | min | 58 cm  |
| L | max | 140 cm |

### supplementi

Profilo tenuta acqua basso  
Low sealed profile

Profilo di compensazione 2 cm  
Extension profile 2 cm

Decografia  
Decoprinting

Sigillante SPARTAN®  
Sealant SPARTAN®

37R019220

37P019219

per codice  
for code

36B010010

|                |       |        |          |       |       |      |      |            |      |             |              |          |            |
|----------------|-------|--------|----------|-------|-------|------|------|------------|------|-------------|--------------|----------|------------|
| 05             | 11    | 12     | 16       | 24    | 25    | 26   | 27   | 28         | 29   | 30          | 31           | 32       | 34         |
| acrilico satin | flack | reflex | satinato | nigol | flute | wave | alou | fumè brown | fumè | trasparente | extrachiario | cincillà | stampato C |

|                     |                                    |  |
|---------------------|------------------------------------|--|
| origin              | abitat                             | vogue  |
| 59 Nero / 60 Bianco | 27 Tcrom® / 21 Tinox® / 22 Tbronz® | 61 Orosatinato / 62 Ororosa / 63 Cromonero / 64 Franciacorta / 65 Rame / 66 Brownie / Colori |

### Approfondimenti Insights



|   |     |
|---|-----|
| Indice<br>Index                           | 3   |
| Legenda simboli<br>Icons legend           | 11  |
| Profili - Vetri<br>Profiles - Glasses     | 21  |
| Ricambi<br>Spare parts                    | 406 |
| Profili speciali<br>Special profiles      | 434 |
| Schede rilievo misure<br>Measurement form | 444 |



incluso included

disponibile available

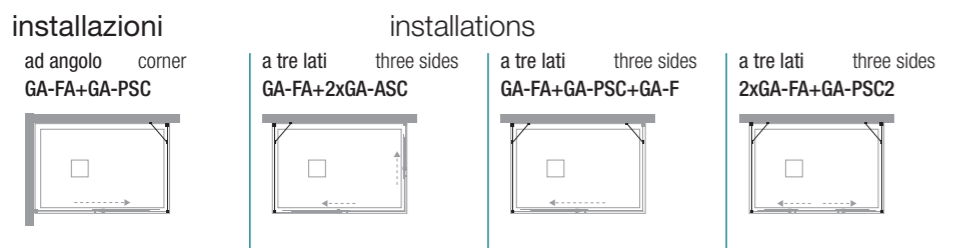

**informazioni informations**

| Y     |  |  |  |  |  |  |  |  |  |   |    |
|-------|--|--|--|--|--|--|--|--|--|---|----|
| 68-70 |  |  |  |  |  |  |  |  |  | 1 | 25 |
| 72-74 |  |  |  |  |  |  |  |  |  | 1 | 26 |
| 76-78 |  |  |  |  |  |  |  |  |  | 1 | 27 |
| 78-80 |  |  |  |  |  |  |  |  |  | 1 | 29 |
| 80-82 |  |  |  |  |  |  |  |  |  | 1 | 29 |
| 88-90 |  |  |  |  |  |  |  |  |  | 1 | 32 |

Y lunghezza parete doccia\ shower wall length

**Misure standard Standard sizes**

| Codice Code | estensibilità extension | Finiture profili Profiles finishing | 30 | 16 | 29 | 28 | 12 |
|-------------|-------------------------|-------------------------------------|----|----|----|----|----|
| 07F050068   | 68-70                   | origin<br>abitat<br>vogue           |    |    |    |    |    |
| 07F050072   | 72-74                   | origin<br>abitat<br>vogue           |    |    |    |    |    |
| 07F050076   | 76-78                   | origin<br>abitat<br>vogue           |    |    |    |    |    |
| 07F050078   | 78-80                   | origin<br>abitat<br>vogue           |    |    |    |    |    |
| 07F050080   | 80-82                   | origin<br>abitat<br>vogue           |    |    |    |    |    |
| 07F050088   | 88-90                   | origin<br>abitat<br>vogue           |    |    |    |    |    |

**Misure speciali L / H Special sizes L / H**

| Codice Code | su misura bespoke | Finiture profili Profiles finishing | 30 | 16 | 29 | 28 | 24 | 27 | 12 |
|-------------|-------------------|-------------------------------------|----|----|----|----|----|----|----|
| 07F059001   | 16 < L < 60       | origin<br>abitat<br>vogue           |    |    |    |    |    |    |    |
| 07F059001   | 61 < L < 80       | origin<br>abitat<br>vogue           |    |    |    |    |    |    |    |
| 07F059001   | 81 < L < 100      | origin<br>abitat<br>vogue           |    |    |    |    |    |    |    |
| 07F059001   | 101 < L < 120     | origin<br>abitat<br>vogue           |    |    |    |    |    |    |    |

**attenzione warning**

Il prezzo della H speciale va trovato nella tabella Misure speciali L / H in base alla L della parete doccia

Special price for H is to be found in **Special sizes L / H** as per L needed size

Optical e Terra - decografia per: vetro Trasparente e Fumè, Misure standard e speciali, max L 135 cm

Optical and Terra - decopyrinting for: glass Trasparente and Fumè, Standard and Special sizes, max L 135 cm

Incluso: doppio supporto di rinforzo regolabile e snodato

Included: double adjustable, articulated supporting bar

Specificare se installato a pavimento

Specify any floor installation

**supplementi supplements**

| Profilo di compensazione 2 cm Extension profile 2 cm | Decografia Decopyrinting | Sigillante SPARTAN® Sealant SPARTAN® |
|--|--------------------------|--------------------------------------|
| 37P019219  | per codice for code      | 36B010010                            |

| 05                   | 11     | 12 | 16                                  | 24    | 25    | 26   | 27   | 28   | 29   | 30          | 31          | 32       | 34         |
|----------------------|--------|----|-------------------------------------|-------|-------|------|------|--|------|-------------|-------------|----------|------------|
| acrilico satin flack | reflex |    | satinato                            | nigol | flute | wave | alou | fumè brown   | fumè | trasparente | extrachiaro | cincillà | stampato C |
| origin               |        |    | abitat                              |       |       |      |      | vogue  |      |             |             |          |            |
| 59 Nero / 60 Bianco  |        |    | 27 Tcrom® / 21 Tinox® / 22 Tbronze® |       |       |      |      | 61 Orosatinato / 62 Ororosa / 63 Cromonero / 64 Franciacorta / 65 Rame / 66 Brownie / Colori |      |             |             |          |            |

**Approfondimenti Insights**

|  |     |
|--|-----|
| Indice Index                           | 3   |
| Legenda simboli Icons legend           | 11  |
| Profili - Vetri Profiles - Glasses     | 21  |
| Ricambi Spare parts                    | 406 |
| Profili speciali Special profiles      | 434 |
| Schede rilievo misure Measurement form | 444 |

## CON PROFILO VERTICALE WITH VERTICAL PROFILE

# MORK



Porta battente installazione in nicchia  
profilo Sky / vetro Trasparente  
Piatto doccia AMBROGIO

Hinged door niche installation  
Sky profile / Transparent glass  
Shower tray AMBROGIO

## MORK

L'apertura delle porte a battente con innovativo sistema di rotazione su camma, i profili di rotazione piatti e la chiusura magnetica accentuano la flessibilità di questi modelli. Adattabile a tutte le necessità di installazione. I suoi tratti distintivi sono: il perno di rotazione, dal morphing estetico piatto; un ampio angolo di rotazione e l'apprezzata caratteristica del punto di orbita traslato, ideale per le grandi dimensioni e per risolvere i casi di ingombro esterno

The swinging door opens with an innovative cam rotation system, which, together with the flat rotation profiles and the magnetic closing system, enhances the flexibility of these models. Adaptable to a number of installation necessities, its main features are: the rotation pivot, with a flat aesthetic morphing; a wide rotation angle and the appreciated door with a shifted orbit point, ideal for large dimensions and for solving cases of external obstruction



01



02



03

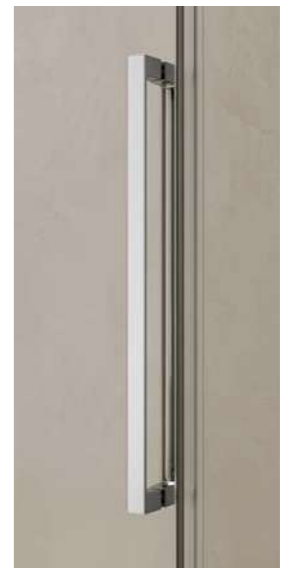

04

01 chiusura magnetica del modello IN/OUT | 02 perno di rotazione inferiore con protezione laterale | 03 tappi di chiusura per profili verticali | 04 doppia maniglia esterna/interna interasse 32 cm |

01 magnetic closure of the IN / OUT model | 02 lower pivot pin with side protection | 03 caps for vertical profiles | 04 double external/internal handle, interaxe 32 cm |



**CARATTERISTICHE**  
FEATURES

-  ALTEZZA PARETI DOCCIA  
SHOWER DOOR HEIGHT
-  SPESSORE LASTRA  
GLASS DEPTH
-  REVERSIBILE  
REVERSIBLE

**INFO TECNICHE**  
TECHNICAL INFORMATION







-  REGOLAZIONE FUORI SQUADRO  
OFF-SQUARE REGULATION
-  ESTENSIBILITÀ 2/4  
EXSTENSIBILITY 2/4
-  CHIUSURA MAGNETICA  
MAGNETIC CLOSURE
-  ROTAZIONE A CAMMA  
CAM ROTATION
-  PROFILO TENUTA ACQUA  
LOW SEAL WATER PROFILE
-  MANIGLIE ESTERNA/INTERNA  
EXTERNAL/INTERNAL HANDLES
-  TRATTAMENTO NEVERDROP®  
NEVERDROP® TREATMENT
-  MISURE SPECIALI  
SPECIAL SIZES
-  DECOGRAFIA  
DECOPRINTING

**Finiture profili**

|  |   |   |
|--|---|---|
| <b>ORIGIN</b>  | <b>ABITAT</b>   | <b>VOGUE</b>  |
|  |  |  |
| 59<br>Nero   | 60<br>Bianco  | 27<br>Tcrom®  |
|  | 21<br>Tinox®  | 22<br>Tbronz®   |
|  | 61<br>Orosatinato   | 62<br>Ororosa   |
|  | 63<br>Cromonero   | Colori  |
|  | 64<br>Franciacorta  | 65<br>Rame  |
|  | 66<br>Brownie   |   |

**Vetri**

**Glasses**

|  |   |   |   |   |   |   |
|--|---|---|---|---|---|---|
|  |  |  |  |  |  |  |
| 27<br>Aion   | 30<br>Trasparente   | 29<br>Fumè  | 28<br>Fumè Brown  | 16<br>Satinato  | 12<br>Reflex  | 32<br>Cincillà  |

**in nicchia**

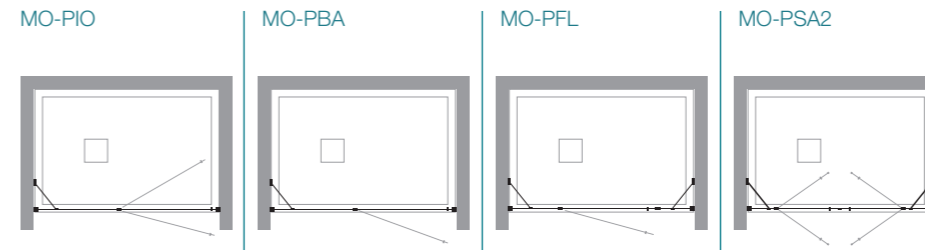

**ad angolo**

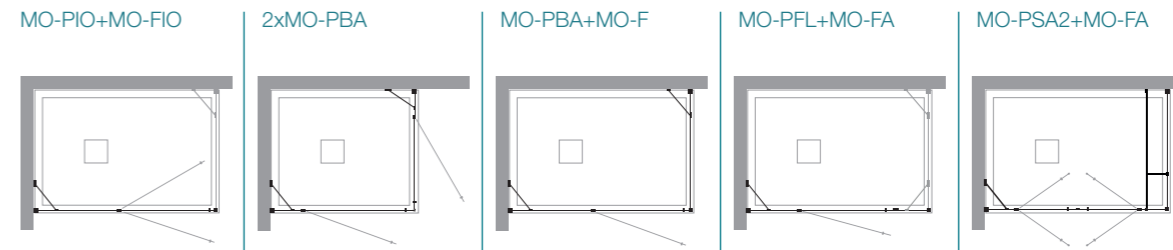

**a tre lati**

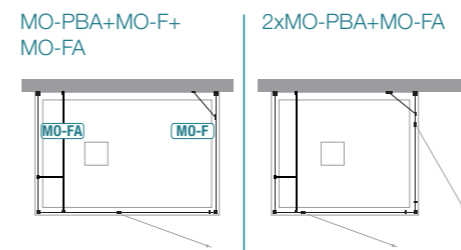

**semicircolari**

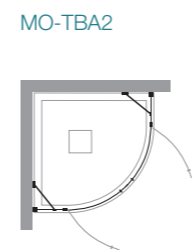

**niche**

**corner**

**three sides**

**quadrant**

**profili**

**profiles**

per/for **MO: PBA-PFL-PSA2-F-FA-TBA2**

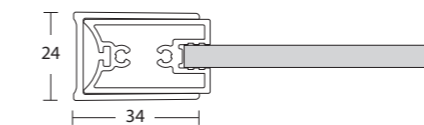

profilo a muro 1125 + schienale 1212  
wall profile 1125 + vertical profile 1212

per/for **MO-PIO**

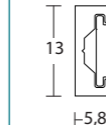

chiusura con magnete 1293  
magnetic closing 1293

per/for **MO-PBA**

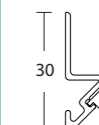

chiusura con magnete 1128  
magnetic closing 1128

**importante**

**important**

ordini per pareti doccia speciali senza relativo disegno  
**NON** vengono prodotti

orders for special shower walls without related design are  
**NOT** produced

per installazioni particolari richiedere fattibilità. Alcune  
configurazioni necessitano di elementi aggiuntivi

contact TDA technical office for particular installation. More  
elements could be needed

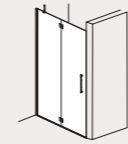

incluso

included



disponibile

available



installazioni

installations

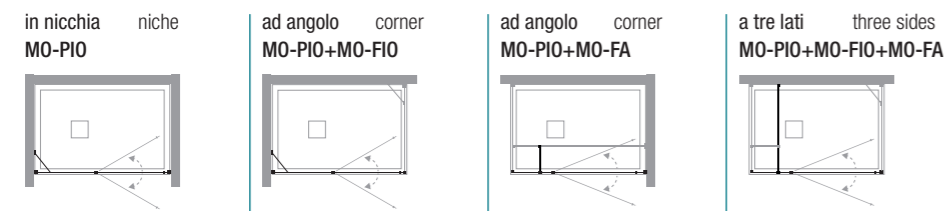

informazioni

informations

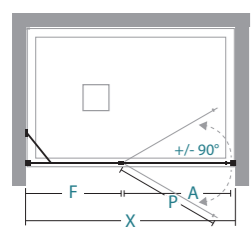

apertura battente IN/OUT  
IN/OUT swing door

|         | X  | A  | P  | F |  |  |  |  |   |    |
|---------|----|----|----|---|--|--|--|--|---|----|
| 77-79   | 50 | 51 | 24 |   |  |  |  |  | 1 | 30 |
| 87-89   | 60 | 61 | 24 |   |  |  |  |  | 1 | 33 |
| 97-99   | 70 | 71 | 24 |   |  |  |  |  | 1 | 36 |
| 107-109 | 80 | 81 | 24 |   |  |  |  |  | 1 | 40 |
| 117-119 | 60 | 61 | 54 |   |  |  |  |  | 2 | 43 |
| 127-129 | 70 | 71 | 54 |   |  |  |  |  | 2 | 47 |
| 137-139 | 80 | 81 | 54 |   |  |  |  |  | 2 | 50 |

X lunghezza parete doccia\ shower wall length  
A spazio d'entrata\ entrance space  
P lunghezza porta\ door length  
F lunghezza lato fisso\ fixed side length

Misure standard

Standard sizes

| Codice Code | estensibilità extension | Finiture profili Profiles finishing | 30 | 32 | 16 | 29 | 28 | 12 |
|-------------|-------------------------|-------------------------------------|----|----|----|----|----|----|
| 08A020080   | 77-79                   | origin<br>abitat<br>vogue           |    |    |    |    |    |    |
| 08A020090   | 87-89                   | origin<br>abitat<br>vogue           |    |    |    |    |    |    |
| 08A020100   | 97-99                   | origin<br>abitat<br>vogue           | ■  |    |    |    |    |    |
| 08A020110   | 107-109                 | origin<br>abitat<br>vogue           |    |    |    |    |    |    |
| 08A020120   | 117-119                 | origin<br>abitat<br>vogue           | ■  |    |    |    |    |    |
| 08A020130   | 127-129                 | origin<br>abitat<br>vogue           |    |    |    |    |    |    |
| 08A020140   | 137-139                 | origin<br>abitat<br>vogue           |    |    |    |    |    |    |

Misure speciali L / H

Special sizes L / H

| Codice Code | su misura bespoke | Finiture profili Profiles finishing | 30 | 32 | 16 | 29 | 28 | 27 | 12 |
|-------------|-------------------|-------------------------------------|----|----|----|----|----|----|----|
| 08A029001   | 40 < L < 60       | origin<br>abitat<br>vogue           |    |    |    |    |    |    |    |
| 08A029001   | 61 < L < 90       | origin<br>abitat<br>vogue           |    |    |    |    |    |    |    |
| 08A029001   | 91 < L < 120      | origin<br>abitat<br>vogue           |    |    |    |    |    |    |    |
| 08A029001   | 121 < L < 150     | origin<br>abitat<br>vogue           |    |    |    |    |    |    |    |
| 08A029001   | 151 < L < 180     | origin<br>abitat<br>vogue           |    |    |    |    |    |    |    |

attenzione

warning

Il prezzo della H speciale va trovato nella tabella Misure speciali L / H in base alla L della parete doccia

Special price for H is to be found in Special sizes L / H as per L needed size

Optical e Terra - decografia per: vetro Trasparente e Fumè, Misure standard e speciali, max L 135 cm

Optical and Terra - decoprinting for: glass Trasparente and Fumè, Standard and Special sizes, max L 135 cm

Incluso: supporto di rinforzo regolabile e snodato

Included: adjustable, articulated supporting bar

La lunghezza della porta MO-PIO abbinata a MO-FIO aumenta di 1,3 cm

Total length of MO-PIO combined with MO-FIO is 1,3 cm longer

Misure speciali

Disponibilità

| Special size | Availability |        |
|--------------|--------------|--------|
| H max 210 cm | ■ STOCK      | Tcrom® |
| L min 40 cm  |              |        |
| L max 180 cm |              |        |

supplementi

supplements

| Profilo di compensazione 2 cm<br>Extension profile 2 cm | Decografia<br>Decoprinting | Sigillante SPARTAN®<br>Sealant SPARTAN® |
|---|----------------------------|---|
| 37P019221   | per codice<br>for code     | 36B010010                               |

| 05             | 11    | 12     | 16       | 24    | 25    | 26   | 27   | 28         | 29   | 30          | 31          | 32       | 34         |
|----------------|-------|--------|----------|-------|-------|------|------|------------|------|-------------|-------------|----------|------------|
| acrilico satin | flack | reflex | satinato | nigol | flute | wave | alou | fumè brown | fumè | trasparente | extrachiaro | cincillà | stampato C |

| origin              | abitat                            | vogue  |
|---------------------|-----------------------------------|--|
| 59 Nero / 60 Bianco | 27 Tcrom® / 21 Tinox® / 22 Tbron® | 61 Orosatinato / 62 Ororosa / 63 Cromonero / 64 Franciacorta / 65 Rame / 66 Brownie / Colori |

Approfondimenti



|  |     |
|--|-----|
| Indice Index                           | 3   |
| Legenda simboli Icons legend           | 11  |
| Profili - Vetri Profiles - Glasses     | 21  |
| Ricambi Spare parts                    | 406 |
| Profili speciali Special profiles      | 434 |
| Schede rilievo misure Measurement form | 444 |

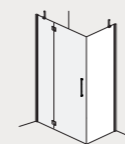

incluso

included



disponibile

available

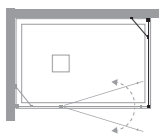

## installazioni

ad angolo corner  
MO-FIO+MO-PIO

## installations

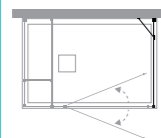
a tre lati three sides  
MO-FIO+MO-PIO+MO-FA

## informazioni

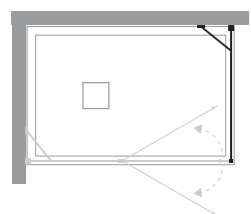

Y lunghezza parete doccia\ shower wall length

## informations

| Y           |  |  |  |  |  | nr | Kg max |
|-------------|--|--|--|--|--|----|--------|
| 66,5-68,5   |  |  |  |  |  | 1  | 27     |
| 71,5-73,5   |  |  |  |  |  | 1  | 28     |
| 76,5-78,5   |  |  |  |  |  | 1  | 29     |
| 86,5-88,5   |  |  |  |  |  | 1  | 32     |
| 96,5-98,5   |  |  |  |  |  | 1  | 35     |
| 116,5-118,5 |  |  |  |  |  | 1  | 42     |

## Misure standard

## Standard sizes

| Codice Code | estensibilità extension | Finiture profili Profiles finishing | 30 | 32 | 16 | 29 | 28 | 12 |
|-------------|-------------------------|-------------------------------------|----|----|----|----|----|----|
| 08F030070   | 66,5-68,5               | origin<br>abitat<br>vogue           |    |    |    |    |    |    |
| 08F030075   | 71,5-73,5               | origin<br>abitat<br>vogue           |    |    |    |    |    |    |
| 08F030080   | 76,5-78,5               | origin<br>abitat<br>vogue           |    |    |    |    |    |    |
| 08F030090   | 86,5-88,5               | origin<br>abitat<br>vogue           |    |    |    |    |    |    |
| 08F030100   | 96,5-98,5               | origin<br>abitat<br>vogue           |    |    |    |    |    |    |
| 08F030120   | 116,5-118,5             | origin<br>abitat<br>vogue           |    |    |    |    |    |    |

## Misure speciali L / H

## Special sizes L / H

| Codice Code | su misura bespoke | Finiture profili Profiles finishing | 30 | 32 | 16 | 29 | 28 | 27 | 12 |
|-------------|-------------------|-------------------------------------|----|----|----|----|----|----|----|
| 08F039001   | 12 < L < 40       | origin<br>abitat<br>vogue           |    |    |    |    |    |    |    |
| 08F039001   | 41 < L < 60       | origin<br>abitat<br>vogue           |    |    |    |    |    |    |    |
| 08F039001   | 61 < L < 90       | origin<br>abitat<br>vogue           |    |    |    |    |    |    |    |
| 08F039001   | 91 < L < 120      | origin<br>abitat<br>vogue           |    |    |    |    |    |    |    |
| 08F039001   | 121 < L < 150     | origin<br>abitat<br>vogue           |    |    |    |    |    |    |    |
| 08F039001   | 151 < L < 180     | origin<br>abitat<br>vogue           |    |    |    |    |    |    |    |

## attenzione

Il prezzo della H speciale va trovato nella tabella Misure speciali L / H in base alla L della parete doccia

Special price for H is to be found in Special sizes L / H as per L needed size

## warning

Optical e Terra - decografia per: vetro Trasparente e Fumè, Misure standard e speciali, max L 135 cm

Optical and Terra - decoprinting for: glass Trasparente and Fumè, Standard and Special sizes, max L 135 cm

Incluso: supporto di rinforzo regolabile e snodato

Included: adjustable, articulated supporting bar

Misure speciali  
Special size

H max 210 cm  
L min 12 cm  
L max 180 cm

Disponibilità  
Availability

■ STOCK Tcrom®

## supplementi

Profilo di compensazione 2 cm  
Extension profile 2 cm

Decografia  
Decoprinting

€

## supplements

Sigillante SPARTAN®  
Sealant SPARTAN®

€

37P019221

per codice  
for code

36B010010

05 acrilico satin 11 flack 12 reflex 16 satinato 24 nigol 25 flute 26 wave 27 alon 28 fumè brown 29 fumè 30 trasparente 31 extrachiaro 32 cincià 34 stampato C

origin abitat vogue  
59 Nero / 60 Bianco 27 Tcrom® / 21 Tinox® / 22 Tbron® 61 Orosatinato / 62 Ororosa / 63 Cromonero / 64 Franciacorta / 65 Rame / 66 Brownie / Colori

Approfondimenti  
Insights

|  |     |
|--|-----|
| Indice Index                           | 3   |
| Legenda simboli Icons legend           | 11  |
| Profili - Vetri Profiles - Glasses     | 21  |
| Ricambi Spare parts                    | 406 |
| Profili speciali Special profiles      | 434 |
| Schede rilievo misure Measurement form | 444 |





incluso      included

disponibile      available

installazioni

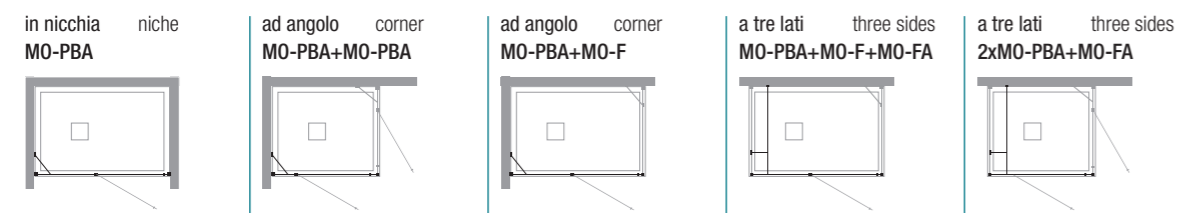

informazioni

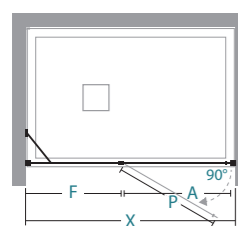

informations

apertura battente  
swing door

|             | X  | A  | P  | F |  |  |   |    |
|-------------|----|----|----|---|--|--|---|----|
| 67,5-69,5   | 40 | 41 | 24 |   |  |  | 1 | 28 |
| 72,5-74,5   | 45 | 46 | 24 |   |  |  | 1 | 30 |
| 77,5-79,5   | 50 | 51 | 24 |   |  |  | 1 | 32 |
| 87,5-89,5   | 60 | 61 | 24 |   |  |  | 1 | 35 |
| 97,5-99,5   | 70 | 71 | 24 |   |  |  | 1 | 38 |
| 107,5-109,5 | 80 | 81 | 24 |   |  |  | 1 | 42 |
| 117,5-119,5 | 60 | 61 | 54 |   |  |  | 2 | 45 |
| 127,5-129,5 | 70 | 71 | 54 |   |  |  | 2 | 49 |
| 137,5-139,5 | 80 | 81 | 54 |   |  |  | 2 | 52 |

**X** lunghezza parete doccia\ shower wall length  
**A** spazio d'entrata\ entrance space  
**P** lunghezza porta\ door length  
**F** lunghezza lato fisso\ fixed side length

Misure standard

| Codice Code | estensibilità extension | Finiture profili Profiles finishing | 30 | 32 | 16 | 29 | 28 | 12 |
|-------------|-------------------------|-------------------------------------|----|----|----|----|----|----|
| 08A010070   | 67,5-69,5               | origin<br>abitat<br>vogue           |    |    |    |    |    |    |
| 08A010075   | 72,5-74,5               | origin<br>abitat<br>vogue           |    |    |    |    |    |    |
| 08A010080   | 77,5-79,5               | origin<br>abitat<br>vogue           |    |    |    |    |    |    |
| 08A010090   | 87,5-89,5               | origin<br>abitat<br>vogue           |    |    |    |    |    |    |
| 08A010100   | 97,5-99,5               | origin<br>abitat<br>vogue           |    |    |    |    |    |    |
| 08A010110   | 107,5-109,5             | origin<br>abitat<br>vogue           |    |    |    |    |    |    |
| 08A010120   | 117,5-119,5             | origin<br>abitat<br>vogue           |    |    |    |    |    |    |
| 08A010130   | 127,5-129,5             | origin<br>abitat<br>vogue           |    |    |    |    |    |    |
| 08A010140   | 137,5-139,5             | origin<br>abitat<br>vogue           |    |    |    |    |    |    |

Misure speciali L / H

| Codice Code | su misura bespoke | Finiture profili Profiles finishing | 30 | 32 | 16 | 29 | 28 | 27 | 12 |
|-------------|-------------------|-------------------------------------|----|----|----|----|----|----|----|
| 08A019001   | 40 < L < 60       | origin<br>abitat<br>vogue           |    |    |    |    |    |    |    |
| 08A019001   | 61 < L < 90       | origin<br>abitat<br>vogue           |    |    |    |    |    |    |    |
| 08A019001   | 91 < L < 120      | origin<br>abitat<br>vogue           |    |    |    |    |    |    |    |
| 08A019001   | 121 < L < 150     | origin<br>abitat<br>vogue           |    |    |    |    |    |    |    |
| 08A019001   | 151 < L < 180     | origin<br>abitat<br>vogue           |    |    |    |    |    |    |    |

attenzione

Il prezzo della H speciale va trovato nella tabella Misure speciali L / H in base alla L della parete doccia

Special price for H is to be found in Special sizes L / H as per L needed size

Misure speciali Special size

H max 210 cm  
L min 40 cm  
L max 180 cm

warning

Optical e Terra - decografia per: vetro Trasparente e Fumè, Misure standard e speciali, max L 135 cm

Optical and Terra - decoprinting for: glass Trasparente and Fumè, Standard and Special sizes, max L 135 cm

Disponibilità Availability

STOCK Tcrom®

Incluso: supporto di rinforzo regolabile e snodato

Included: adjustable, articulated supporting bar

Per installazioni a tre lati con larghezze > 140 cm contattare l'ufficio tecnico TDA

Contact TDA technical office for three sides installation L > 140 cm

supplementi

Profilo di compensazione 2 cm  
Extension profile 2 cm

€

37P019221

per codice for code

supplements

Decografia Decoprinting

€

36B010010

€

| 05             | 11    | 12     | 16       | 24    | 25    | 26   | 27   | 28         | 29   | 30          | 31          | 32       | 34         |
|----------------|-------|--------|----------|-------|-------|------|------|------------|------|-------------|-------------|----------|------------|
| acrilico satin | flack | reflex | satinato | nigol | flute | wave | alou | fumè brown | fumè | trasparente | extrachiaro | cincillà | stampato C |

origin      abitat      vogue

59 Nero / 60 Bianco      27 Tcrom® / 21 Tinox® / 22 Tbronze®      61 Orosatinato / 62 Ororosa / 63 Cromonero / 64 Franciacorta / 65 Rame / 66 Brownie / Colori

Approfondimenti  
Insights



|  |     |
|--|-----|
| Indice Index                           | 3   |
| Legenda simboli Icons legend           | 11  |
| Profili - Vetri Profiles - Glasses     | 21  |
| Ricambi Spare parts                    | 406 |
| Profili speciali Special profiles      | 434 |
| Schede rilievo misure Measurement form | 444 |

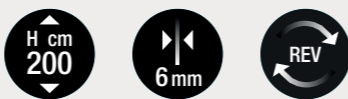
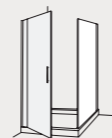

incluso included



disponibile available



installazioni

ad angolo corner  
MO-F+MO-PBA

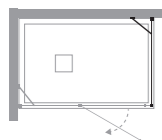

installations

a tre lati three sides  
MO-F+MO-PBA+MO-FA

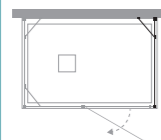

informazioni

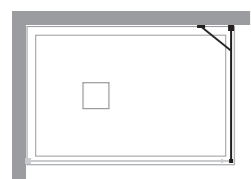

informations

| Y           |  |  |  |  |  |  |  |  |  |  |   |    |
|-------------|--|--|--|--|--|--|--|--|--|--|---|----|
| 67,5-69,5   |  |  |  |  |  |  |  |  |  |  | 1 | 27 |
| 72,5-74,5   |  |  |  |  |  |  |  |  |  |  | 1 | 28 |
| 77,5-79,5   |  |  |  |  |  |  |  |  |  |  | 1 | 29 |
| 87,5-89,5   |  |  |  |  |  |  |  |  |  |  | 1 | 32 |
| 97,5-99,5   |  |  |  |  |  |  |  |  |  |  | 1 | 35 |
| 117,5-119,5 |  |  |  |  |  |  |  |  |  |  | 1 | 42 |

Y lunghezza parete doccia \ shower wall length

Misure standard

Standard sizes

| Codice Code | estensibilità extension | Finiture profili Profiles finishing | 30 | 32 | 16 | 29 | 28 | 12 |
|-------------|-------------------------|-------------------------------------|----|----|----|----|----|----|
| 08F010070   | 67,5-69,5               | origin                              |    |    |    |    |    |    |
|             |                         | abitat                              | ■  |    |    |    |    |    |
|             |                         | vogue                               |    |    |    |    |    |    |
| 08F010075   | 72,5-74,5               | origin                              |    |    |    |    |    |    |
|             |                         | abitat                              |    |    |    |    |    |    |
|             |                         | vogue                               |    |    |    |    |    |    |
| 08F010080   | 77,5-79,5               | origin                              |    |    |    |    |    |    |
|             |                         | abitat                              | ■  |    |    |    |    |    |
|             |                         | vogue                               |    |    |    |    |    |    |
| 08F010090   | 87,5-89,5               | origin                              |    |    |    |    |    |    |
|             |                         | abitat                              | ■  |    |    |    |    |    |
|             |                         | vogue                               |    |    |    |    |    |    |
| 08F010100   | 97,5-99,5               | origin                              |    |    |    |    |    |    |
|             |                         | abitat                              | ■  |    |    |    |    |    |
|             |                         | vogue                               |    |    |    |    |    |    |
| 08F010120   | 117,5-119,5             | origin                              |    |    |    |    |    |    |
|             |                         | abitat                              |    |    |    |    |    |    |
|             |                         | vogue                               |    |    |    |    |    |    |

Misure speciali L / H

Special sizes L / H

| Codice Code | su misura bespoke | Finiture profili Profiles finishing | 30 | 32 | 16 | 29 | 28 | 27 | 12 |
|-------------|-------------------|-------------------------------------|----|----|----|----|----|----|----|
| 08F019001   | 12 < L < 40       | origin                              |    |    |    |    |    |    |    |
|             |                   | abitat                              |    |    |    |    |    |    |    |
|             |                   | vogue                               |    |    |    |    |    |    |    |
| 08F019001   | 41 < L < 60       | origin                              |    |    |    |    |    |    |    |
|             |                   | abitat                              |    |    |    |    |    |    |    |
|             |                   | vogue                               |    |    |    |    |    |    |    |
| 08F019001   | 61 < L < 90       | origin                              |    |    |    |    |    |    |    |
|             |                   | abitat                              |    |    |    |    |    |    |    |
|             |                   | vogue                               |    |    |    |    |    |    |    |
| 08F019001   | 91 < L < 120      | origin                              |    |    |    |    |    |    |    |
|             |                   | abitat                              |    |    |    |    |    |    |    |
|             |                   | vogue                               |    |    |    |    |    |    |    |
| 08F019001   | 121 < L < 150     | origin                              |    |    |    |    |    |    |    |
|             |                   | abitat                              |    |    |    |    |    |    |    |
|             |                   | vogue                               |    |    |    |    |    |    |    |
| 08F019001   | 151 < L < 180     | origin                              |    |    |    |    |    |    |    |
|             |                   | abitat                              |    |    |    |    |    |    |    |
|             |                   | vogue                               |    |    |    |    |    |    |    |

attenzione

Il prezzo della H speciale va trovato nella tabella Misure speciali L / H in base alla L della parete doccia

Special price for H is to be found in Special sizes L / H as per L needed size

warning

Optical e Terra - decografia per: vetro Trasparente e Fumè, Misure standard e speciali, max L 135 cm

Optical and Terra - decoprinting for: glass Trasparente and Fumè, Standard and Special sizes, max L 135 cm

Incluso: supporto di rinforzo regolabile e snodato

Included: adjustable, articulated supporting bar

Misure speciali Special size

H max 210 cm  
L min 12 cm  
L max 180 cm

Disponibilità Availability

■ STOCK Tcrom®

supplementi

Profilo di compensazione 2 cm  
Extension profile 2 cm

Decografia Decoprinting

supplements

Sigillante SPARTAN®  
Sealant SPARTAN®

37P019221

per codice for code

36B010010

|                |       |        |          |       |       |      |      |            |      |             |              |          |            |
|----------------|-------|--------|----------|-------|-------|------|------|------------|------|-------------|--------------|----------|------------|
| 05             | 11    | 12     | 16       | 24    | 25    | 26   | 27   | 28         | 29   | 30          | 31           | 32       | 34         |
| acrilico satin | flack | reflex | satinato | nigol | flute | wave | alon | fumè brown | fumè | trasparente | extrachiario | cincillà | stampato C |

origin abitat vogue  
59 Nero / 60 Bianco 27 Tcrom® / 21 Tinox® / 22 Tbronx® 61 Orosatinato / 62 Ororosa / 63 Cromonero / 64 Franciacorta / 65 Rame / 66 Brownie / Colori

Approfondimenti Insights



|  |     |
|--|-----|
| Indice Index                           | 3   |
| Legenda simboli Icons legend           | 11  |
| Profili - Vetri Profiles - Glasses     | 21  |
| Ricambi Spare parts                    | 406 |
| Profili speciali Special profiles      | 434 |
| Schede rilievo misure Measurement form | 444 |



incluso

included



disponibile

available



installazioni

in nicchia niche  
MO-PFL

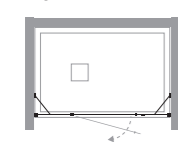

installations

ad angolo corner  
MO-PFL+MO-FA

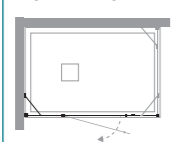

informazioni

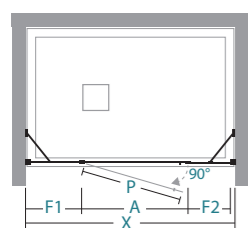

apertura battente swing door

informations

|         | X  | A  | P  | F1   | F2 |  |  |   |
|---------|----|----|----|------|----|--|--|---|
| 106-110 | 60 | 61 | 24 | 19.5 |    |  |  | 2 |
| 116-120 | 70 | 71 | 24 | 19.5 |    |  |  | 2 |
| 126-130 | 70 | 71 | 24 | 29.5 |    |  |  | 2 |
| 136-140 | 80 | 81 | 24 | 29.5 |    |  |  | 2 |
| 146-150 | 80 | 81 | 24 | 39.5 |    |  |  | 2 |
| 156-160 | 80 | 81 | 24 | 49.5 |    |  |  | 2 |
| 166-170 | 80 | 81 | 24 | 59.5 |    |  |  | 2 |
| 176-180 | 80 | 81 | 24 | 69.5 |    |  |  | 2 |

X lunghezza parete doccia\ shower wall length  
A spazio d'entrata\ entrance space  
P lunghezza porta\ door length  
F1 / F2 lunghezza lato fisso\ fixed side length

Misure standard

Standard sizes

| Codice Code | estensibilità extension | Finiture profili Profiles finishing | 30 | 32 | 16 | 29 | 28 | 12 |
|-------------|-------------------------|-------------------------------------|----|----|----|----|----|----|
| 08P020110   | 106-110                 | origin<br>abitat<br>vogue           |    |    |    |    |    |    |
| 08P020120   | 116-120                 | origin<br>abitat<br>vogue           |    |    |    |    |    |    |
| 08P020130   | 126-130                 | origin<br>abitat<br>vogue           |    |    |    |    |    |    |
| 08P020140   | 136-140                 | origin<br>abitat<br>vogue           |    |    |    |    |    |    |
| 08P020150   | 146-150                 | origin<br>abitat<br>vogue           |    |    |    |    |    |    |
| 08P020160   | 156-160                 | origin<br>abitat<br>vogue           |    |    |    |    |    |    |
| 08P020170   | 166-170                 | origin<br>abitat<br>vogue           |    |    |    |    |    |    |
| 08P020180   | 176-180                 | origin<br>abitat<br>vogue           |    |    |    |    |    |    |

Misure speciali L / H

Special sizes L / H

| Codice Code | su misura bespoke | Finiture profili Profiles finishing | 30 | 32 | 16 | 29 | 28 | 27 | 12 |
|-------------|-------------------|-------------------------------------|----|----|----|----|----|----|----|
| 08P029001   | 90 < L < 120      | origin<br>abitat<br>vogue           |    |    |    |    |    |    |    |
| 08P029001   | 121 < L < 140     | origin<br>abitat<br>vogue           |    |    |    |    |    |    |    |
| 08P029001   | 141 < L < 160     | origin<br>abitat<br>vogue           |    |    |    |    |    |    |    |
| 08P029001   | 161 < L < 180     | origin<br>abitat<br>vogue           |    |    |    |    |    |    |    |
| 08P029001   | 181 < L < 200     | origin<br>abitat<br>vogue           |    |    |    |    |    |    |    |

attenzione

Il prezzo della H speciale va trovato nella tabella Misure speciali L / H in base alla L della parete doccia

Special price for H is to be found in Special sizes L / H as per L needed size

warning

Optical e Terra - decografia per: vetro Trasparente e Fumè, Misure standard e speciali, max L 135 cm

Optical and Terra - decoprinting for: glass Trasparente and Fumè, Standard and Special sizes, max L 135 cm

Incluso: supporto di rinforzo regolabile e snodato

Included: adjustable, articulated supporting bar

Per ottenere l'apertura IN/OUT sostituire la guarnizione in dotazione con la guarnizione cod. 37R019327

For IN/OUT installation substitute the included seal with seal code 37R019327

Misure speciali Special size

|       |        |
|-------|--------|
| H max | 210 cm |
| L min | 90 cm  |
| L max | 200 cm |

supplementi

supplements

|   |                                   |                            |   |
|---|-----------------------------------|----------------------------|---|
| Profilo di compensazione 2 cm<br>Extension profile 2 cm | Guarnizione IN/OUT<br>Seal IN/OUT | Decografia<br>Decoprinting | Sigillante SPARTAN®<br>Sealant SPARTAN® |
| €   | €                                 | per codice<br>for code     | €                                       |
| 37P019221   | 37R019327                         |                            | 36B010010                               |

|                |       |        |          |       |       |      |      |            |      |             |             |          |            |
|----------------|-------|--------|----------|-------|-------|------|------|------------|------|-------------|-------------|----------|------------|
| 05             | 11    | 12     | 16       | 24    | 25    | 26   | 27   | 28         | 29   | 30          | 31          | 32       | 34         |
| acrilico satin | flack | reflex | satinato | nigol | flute | wave | alou | fumè brown | fumè | trasparente | extrachiaro | cincillà | stampato C |

|                     |                                     |  |
|---------------------|-------------------------------------|--|
| origin              | abitat                              | vogue  |
| 59 Nero / 60 Bianco | 27 Tcrom® / 21 Tinox® / 22 Tbronze® | 61 Orosatinato / 62 Ororosa / 63 Cromonero / 64 Franciacorta / 65 Rame / 66 Brownie / Colori |

Approfondimenti Insights



|  |     |
|--|-----|
| Indice Index                           | 3   |
| Legenda simboli Icons legend           | 11  |
| Profili - Vetri Profiles - Glasses     | 21  |
| Ricambi Spare parts                    | 406 |
| Profili speciali Special profiles      | 434 |
| Schede rilievo misure Measurement form | 444 |



incluso

included



disponibile

available



installazioni

in nicchia niche  
MO-PSA2

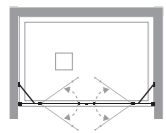

installations

ad angolo corner  
MO-PSA2+MO-FA

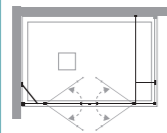

a tre lati three sides  
MO-PSA2+2xMO-FA

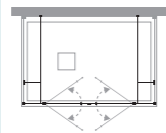

informazioni

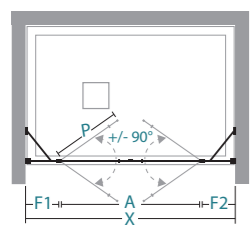

apertura battente swing door

informations

|             | X   | A  | P  | F1/F2 |  |  |  |   |    |
|-------------|-----|----|----|-------|--|--|--|---|----|
| 106,5-110,5 | 54  | 28 | 24 |       |  |  |  | 2 | 43 |
| 116,5-120,5 | 64  | 33 | 24 |       |  |  |  | 2 | 46 |
| 126,5-130,5 | 74  | 38 | 24 |       |  |  |  | 2 | 50 |
| 136,5-140,5 | 84  | 43 | 24 |       |  |  |  | 2 | 53 |
| 146,5-150,5 | 94  | 48 | 24 |       |  |  |  | 2 | 56 |
| 156,5-160,5 | 104 | 53 | 24 |       |  |  |  | 2 | 59 |

X lunghezza parete doccia\ shower wall length  
A spazio d'entrata\ entrance space  
P lunghezza porta\ door length  
F1 / F2 lunghezza lato fisso\ fixed side length

Misure standard

Standard sizes

| Codice Code | estensibilità extension | Finiture profili Profiles finishing | 30 | 32 | 16 | 29 | 28 | 12 |
|-------------|-------------------------|-------------------------------------|----|----|----|----|----|----|
| 08P010110   | 106,5-110,5             | origin<br>abitat<br>vogue           |    |    |    |    |    |    |
| 08P010120   | 116,5-120,5             | origin<br>abitat<br>vogue           |    |    |    |    |    |    |
| 08P010130   | 126,5-130,5             | origin<br>abitat<br>vogue           |    |    |    |    |    |    |
| 08P010140   | 136,5-140,5             | origin<br>abitat<br>vogue           |    |    |    |    |    |    |
| 08P010150   | 146,5-150,5             | origin<br>abitat<br>vogue           |    |    |    |    |    |    |
| 08P010160   | 156,5-160,5             | origin<br>abitat<br>vogue           |    |    |    |    |    |    |

Misure speciali L / H

Special sizes L / H

| Codice Code | su misura bespoke | Finiture profili Profiles finishing | 30 | 32 | 16 | 29 | 28 | 27 | 12 |
|-------------|-------------------|-------------------------------------|----|----|----|----|----|----|----|
| 08P019001   | 100 < L < 120     | origin<br>abitat<br>vogue           |    |    |    |    |    |    |    |
| 08P019001   | 121 < L < 140     | origin<br>abitat<br>vogue           |    |    |    |    |    |    |    |
| 08P019001   | 141 < L < 160     | origin<br>abitat<br>vogue           |    |    |    |    |    |    |    |
| 08P019001   | 161 < L < 180     | origin<br>abitat<br>vogue           |    |    |    |    |    |    |    |
| 08P019001   | 181 < L < 200     | origin<br>abitat<br>vogue           |    |    |    |    |    |    |    |

attenzione

Il prezzo della H speciale va trovato nella tabella Misure speciali L / H in base alla L della parete doccia

Special price for H is to be found in Special sizes L / H as per L needed size

warning

Optical e Terra - decografia per: vetro Trasparente e Fumè, Misure standard e speciali, max L 135 cm

Optical and Terra - decoprinting for: glass Trasparente and Fumè, Standard and Special sizes, max L 135 cm

Incluso: doppio supporto di rinforzo regolabile e snodato

Included: double adjustable, articulated supporting bar

Specificare se installato a pavimento

Specify any floor installation

Per installazioni a tre lati con larghezze > 160 cm contattare l'ufficio tecnico TDA

Contact TDA technical office for three sides installation L > 160 cm

Approfondimenti Insights



|  |     |
|--|-----|
| Indice Index                           | 3   |
| Legenda simboli Icons legend           | 11  |
| Profili - Vetri Profiles - Glasses     | 21  |
| Ricambi Spare parts                    | 406 |
| Profili speciali Special profiles      | 434 |
| Schede rilievo misure Measurement form | 444 |

Misure speciali Special size

|       |        |
|-------|--------|
| H max | 210 cm |
| L min | 100 cm |
| L max | 200 cm |

supplementi

Profilo di compensazione 2 cm Extension profile 2 cm

€

37P019221

per codice for code

supplements

Decografia Decoprinting

€

Sigillante SPARTAN® Sealant SPARTAN®

€

36B010010

|                |       |        |          |       |       |      |      |            |      |             |             |          |            |
|----------------|-------|--------|----------|-------|-------|------|------|------------|------|-------------|-------------|----------|------------|
| 05             | 11    | 12     | 16       | 24    | 25    | 26   | 27   | 28         | 29   | 30          | 31          | 32       | 34         |
| acrilico satin | flack | reflex | satinato | nigol | flute | wave | alon | fumè brown | fumè | trasparente | extrachiaro | cincillà | stampato C |

|                     |                                     |  |
|---------------------|-------------------------------------|--|
| origin              | abitat                              | vogue  |
| 59 Nero / 60 Bianco | 27 Tcrom® / 21 Tinox® / 22 Tbronze® | 61 Orosatinato / 62 Ororosa / 63 Cromonero / 64 Franciacorta / 65 Rame / 66 Brownie / Colori |

















incluso

included





disponibile



available



installazioni

ad angolo corner  
**MO-TBA2**

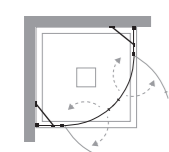

installations

a tre lati three sides  
**MO-TBA2+MO-FA**

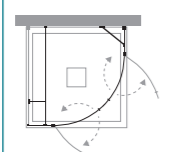

informazioni

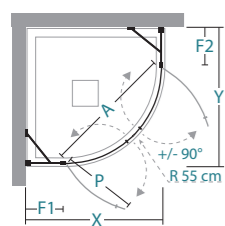

informations

apertura battente swing door

| X/Y   | A  | F1/F2 | P  |  |  |  |  |   |    |
|-------|----|-------|----|--|--|--|--|---|----|
| 78-80 | 74 | 21    | 42 |  |  |  |  | 2 | 51 |
| 88-90 | 74 | 31    | 42 |  |  |  |  | 2 | 58 |

X / Y lunghezza parete doccia \ shower wall length  
 A spazio d'entrata \ entrance space  
 P lunghezza porta \ door length  
 F1 / F2 lunghezza lato fisso \ fixed side length

Misure standard

| Codice Code | estensibilità extension | Finiture profili Profiles finishing | 30 | 16 |
|-------------|-------------------------|-------------------------------------|----|----|
| 08T010080   | 78-80                   | origin<br>abitat<br>vogue           |    |    |
| 08T010090   | 88-90                   | origin<br>abitat<br>vogue           |    |    |

Standard sizes

Misure speciali L

| Codice Code | estensibilità extension | Finiture profili Profiles finishing | 30 | 16 |
|-------------|-------------------------|-------------------------------------|----|----|
| 08T019001   | 72 < L < 77             | origin<br>abitat<br>vogue           |    |    |
| 08T019001   | Standard 78-80          | origin<br>abitat<br>vogue           |    |    |
| 08T019001   | 81 < L < 87             | origin<br>abitat<br>vogue           |    |    |
| 08T019001   | Standard 88-90          | origin<br>abitat<br>vogue           |    |    |
| 08T019001   | 91 < L < 120            | origin<br>abitat<br>vogue           |    |    |

Special sizes L

attenzione

Il prezzo della L speciale va trovato nella tabella Misure speciali L in base alla L della parete doccia

Special price for L is to be found in Special sizes L as per L needed size

warning

Il prezzo delle misure speciali è inteso per lato

Special sizes: prices are to be intended for one side

Incluso: doppio supporto di rinforzo regolabile e snodato

Included: double adjustable, articulated supporting bar

Installazione su piatto doccia semicircolare raggio 55 cm

Installation on quadrant shower tray radius 55 cm

Per installazioni a tre lati richiedere fattibilità all'ufficio tecnico TDA

Contact TDA technical office for three sides installation

Approfondimenti Insights



|  |     |
|--|-----|
| Indice Index                           | 3   |
| Legenda simboli Icons legend           | 11  |
| Profili - Vetri Profiles - Glasses     | 21  |
| Ricambi Spare parts                    | 406 |
| Profili speciali Special profiles      | 434 |
| Schede rilievo misure Measurement form | 444 |

Misure speciali Special size

|       |        |
|-------|--------|
| L min | 72 cm  |
| L max | 120 cm |

Disponibilità Availability

supplementi

Profilo di compensazione 2 cm  
 Extension profile 2 cm

€ 37P019221

supplements

Sigillante SPARTAN®  
 Sealant SPARTAN®

€ 36B010010

|                |       |        |          |       |       |      |      |            |      |             |              |          |            |
|----------------|-------|--------|----------|-------|-------|------|------|------------|------|-------------|--------------|----------|------------|
| 05             | 11    | 12     | 16       | 24    | 25    | 26   | 27   | 28         | 29   | 30          | 31           | 32       | 34         |
| acrilico satin | flack | reflex | satinato | nigol | flute | wave | alon | fumè brown | fumè | trasparente | extrachiario | cincillà | stampato C |

|                     |                                    |  |
|---------------------|------------------------------------|--|
| origin              | abitat                             | vogue  |
| 59 Nero / 60 Bianco | 27 Tcrom® / 21 Tinox® / 22 Tbronz® | 61 Orosatinato / 62 Ororosa / 63 Cromonero / 64 Franciacorta / 65 Rame / 66 Brownie / Colori |















incluso      included









disponibile      available







installazioni

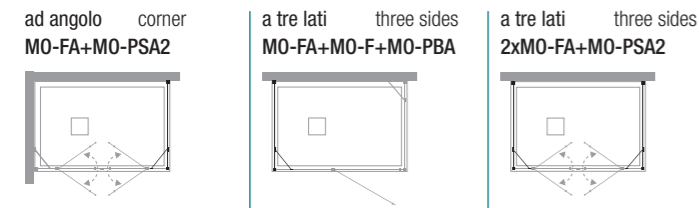

informazioni

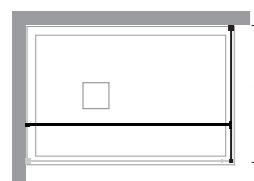

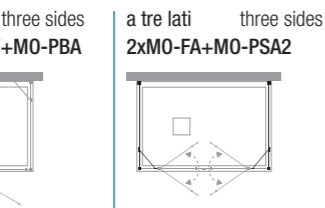

Y lunghezza parete doccia\ shower wall length

installations



informations

| Y           |  |  |  |  |  |  |  |  |  |
|-------------|--|--|--|--|--|--|--|---|---|
| 67,5-69,5   |  |  |  |  |  |  |  | 1   | 27  |
| 72,5-74,5   |  |  |  |  |  |  |  | 1   | 28  |
| 77,5-79,5   |  |  |  |  |  |  |  | 1   | 29  |
| 87,5-89,5   |  |  |  |  |  |  |  | 1   | 32  |
| 97,5-99,5   |  |  |  |  |  |  |  | 1   | 35  |
| 117,5-119,5 |  |  |  |  |  |  |  | 1   | 42  |

Misure standard

| Codice<br>Code | estensibilità<br>extension | Finiture profili<br>Profiles finishing | 30 | 32 | 16 | 29 | 28 | 12 |
|----------------|----------------------------|--|----|----|----|----|----|----|
| 08F020070      | 67,5-69,5                  | origin                                 |    |    |    |    |    |    |
|                |                            | abitat                                 |    |    |    |    |    |    |
|                |                            | vogue                                  |    |    |    |    |    |    |
| 08F020075      | 72,5-74,5                  | origin                                 |    |    |    |    |    |    |
|                |                            | abitat                                 |    |    |    |    |    |    |
|                |                            | vogue                                  |    |    |    |    |    |    |
| 08F020080      | 77,5-79,5                  | origin                                 |    |    |    |    |    |    |
|                |                            | abitat                                 |    |    |    |    |    |    |
|                |                            | vogue                                  |    |    |    |    |    |    |
| 08F020090      | 87,5-89,5                  | origin                                 |    |    |    |    |    |    |
|                |                            | abitat                                 |    |    |    |    |    |    |
|                |                            | vogue                                  |    |    |    |    |    |    |
| 08F020100      | 97,5-99,5                  | origin                                 |    |    |    |    |    |    |
|                |                            | abitat                                 |    |    |    |    |    |    |
|                |                            | vogue                                  |    |    |    |    |    |    |
| 08F020120      | 117,5-119,5                | origin                                 |    |    |    |    |    |    |
|                |                            | abitat                                 |    |    |    |    |    |    |
|                |                            | vogue                                  |    |    |    |    |    |    |

Misure speciali L / H

| Codice<br>Code | su misura<br>bespoke | Finiture profili<br>Profiles finishing | 30 | 32 | 16 | 29 | 28 | 27 | 12 |
|----------------|----------------------|--|----|----|----|----|----|----|----|
| 08F029001      | 16 < L < 40          | origin                                 |    |    |    |    |    |    |    |
|                |                      | abitat                                 |    |    |    |    |    |    |    |
|                |                      | vogue                                  |    |    |    |    |    |    |    |
| 08F029001      | 41 < L < 60          | origin                                 |    |    |    |    |    |    |    |
|                |                      | abitat                                 |    |    |    |    |    |    |    |
|                |                      | vogue                                  |    |    |    |    |    |    |    |
| 08F029001      | 61 < L < 90          | origin                                 |    |    |    |    |    |    |    |
|                |                      | abitat                                 |    |    |    |    |    |    |    |
|                |                      | vogue                                  |    |    |    |    |    |    |    |
| 08F029001      | 91 < L < 120         | origin                                 |    |    |    |    |    |    |    |
|                |                      | abitat                                 |    |    |    |    |    |    |    |
|                |                      | vogue                                  |    |    |    |    |    |    |    |
| 08F029001      | 121 < L < 150        | origin                                 |    |    |    |    |    |    |    |
|                |                      | abitat                                 |    |    |    |    |    |    |    |
|                |                      | vogue                                  |    |    |    |    |    |    |    |
| 08F029001      | 151 < L < 180        | origin                                 |    |    |    |    |    |    |    |
|                |                      | abitat                                 |    |    |    |    |    |    |    |
|                |                      | vogue                                  |    |    |    |    |    |    |    |

attenzione

Il prezzo della H speciale va trovato nella tabella Misure speciali L / H in base alla L della parete doccia

Special price for H is to be found in Special sizes L / H as per L needed size

| Misure speciali<br>Special size | Disponibilità<br>Availability |
|---------------------------------|-------------------------------|
| H max 210 cm                    | STOCK                         |
| L min 16 cm                     |                               |
| L max 180 cm                    |                               |

supplementi

| Profilo di compensazione 2 cm<br>Extension profile 2 cm | Decografia<br>Decoprinting | Sigillante SPARTAN®<br>Sealant SPARTAN® |
|---|----------------------------|---|
| €   | €                          | €                                       |
| 37P019221   | per codice<br>for code     | 36B010010                               |

warning

Optical e Terra - decografia per: vetro Trasparente e Fumè, Misure standard e speciali, max L 135 cm

Optical and Terra - decoprinting for: glass Trasparente and Fumè, Standard and Special sizes, max L 135 cm

Incluso: supporto di rinforzo regolabile e snodato + supporto fisso

Included: adjustable, articulated supporting bar + fixed supporting bar

Per installazioni a tre lati con larghezze > 140 cm contattare l'ufficio tecnico TDA

Contact TDA technical office for three sides installation L > 140 cm

Approfondimenti  
Insights



|   |     |
|---|-----|
| Indice<br>Index                           | 3   |
| Legenda simboli<br>Icons legend           | 11  |
| Profili - Vetri<br>Profiles - Glasses     | 21  |
| Ricambi<br>Spare parts                    | 406 |
| Profili speciali<br>Special profiles      | 434 |
| Schede rilievo misure<br>Measurement form | 444 |

|                |           |           |           |           |           |           |           |            |           |             |             |           |            |
|----------------|-----------|-----------|-----------|-----------|-----------|-----------|-----------|------------|-----------|-------------|-------------|-----------|------------|
| <b>05</b>      | <b>11</b> | <b>12</b> | <b>16</b> | <b>24</b> | <b>25</b> | <b>26</b> | <b>27</b> | <b>28</b>  | <b>29</b> | <b>30</b>   | <b>31</b>   | <b>32</b> | <b>34</b>  |
| acrilico satin | flack     | reflex    | satinato  | nigol     | flute     | wave      | alon      | fumè brown | fumè      | trasparente | extrachiaro | cincillà  | stampato C |

|                     |                                     |  |
|---------------------|-------------------------------------|--|
| <b>origin</b>       | <b>abitat</b>                       | <b>vogue</b>   |
| 59 Nero / 60 Bianco | 27 Tcrom® / 21 Tinox® / 22 Tbronze® | 61 Orosatinato / 62 Ororosa / 63 Cromonero / 64 Franciacorta / 65 Rame / 66 Brownie / Colori |

## CON PROFILO VERTICALE WITH VERTICAL PROFILE

# MINDY



Porta battente installazione in nicchia  
profilo Eucalyptus / vetro Trasparente  
Piatto doccia AURELIO

Hinged door niche installation  
Eucalyptus profile / Transparent glass  
Shower tray AURELIO

## MINDY

L'originale apertura in-out, il movimento ad ala di gabbiano con cerniere piatte del soffietto e la maniglia di 32 cm rendono questi modelli spiccatamente estetici. Il perno di rotazione piatto e il suo ingombro ridotto rendono Mindy una scelta di stile minimal. Un ampio angolo di rotazione delle porte e il sollevamento dell'ante morbido e fluido, dato dal sistema a camma, garantiscono il massimo dell'efficienza

A distinctively aesthetic series: an original in-out opening system, a gull-wing opening movement with flush hinges and a 32 cm-long handle. The flat rotation pivot and its reduced size make Mindy a choice of minimalism. A wide rotation angle for the door and a smooth and fluid door lift, provided by the cam system, ensure maximum efficiency



01



02



03



04

01 cerniera in metallo con apertura interna per soffietto MI-PSO | 02 profili ridotti per chiusura magnetica centrale a 45° | 03 perno di rotazione inferiore con protezione laterale | 04 doppia maniglia esterna/interna interasse 32 cm |

01 metal hinge with inner closing for folding doors MI-PSO | 02 reduced profiles for 45° central magnetic closing | 03 lower pivot pin with side protection | 04 double external/internal handle, interaxe 32 cm |



**CARATTERISTICHE**  
FEATURES

- H cm 200** ALTEZZA PARETI DOCCIA  
SHOWER DOOR HEIGHT
- 6 mm** SPESSORE LASTRA  
GLASS DEPTH
- REV** REVERSIBILE  
REVERSIBLE

**INFO TECNICHE**  
TECHNICAL INFORMATION

- REGOLAZIONE FUORI SQUADRO**  
OFF-SQUARE REGULATION
- EST cm** ESTENSIBILITÀ 2/4  
EXSTENSIBILITY 2/4
- CHIUSURA MAGNETICA**  
MAGNETIC CLOSURE
- ROTAZIONE A CAMMA**  
CAM ROTATION
- CERNIERA 180°**  
180° HINGE
- PROFILO TENUTA ACQUA**  
LOW SEAL WATER PROFILE
- MANIGLIE ESTERNA/INTERNA**  
EXTERNAL/INTERNAL HANDLES
- TRATTAMENTO NEVERDROP®**  
NEVERDROP® TREATMENT
- MISURE SPECIALI**  
SPECIAL SIZES
- DECOGRAFIA**  
DECOPRINTING

**Finiture profili**

**ORIGIN**

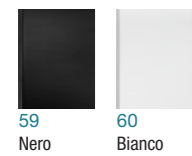

**Profiles finishing**

**ABITAT**

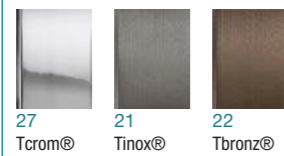

**VOGUE**

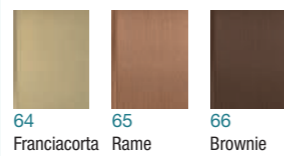
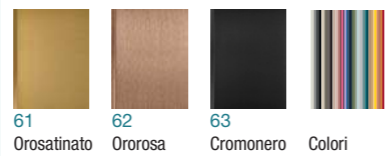

**Vetri**

**Glasses**



**installazioni previste**  
allowed installations

**in nicchia**

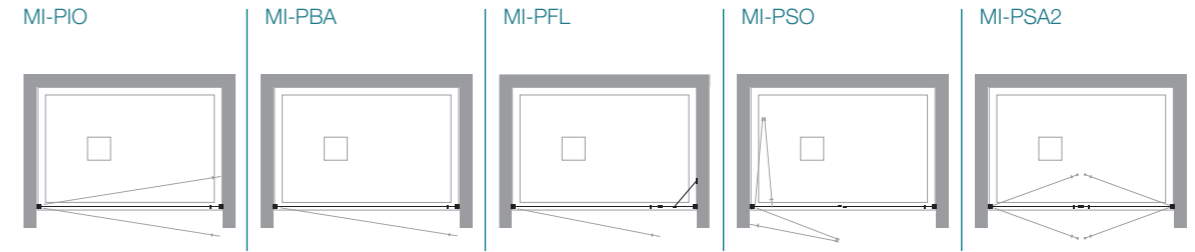

**ad angolo**

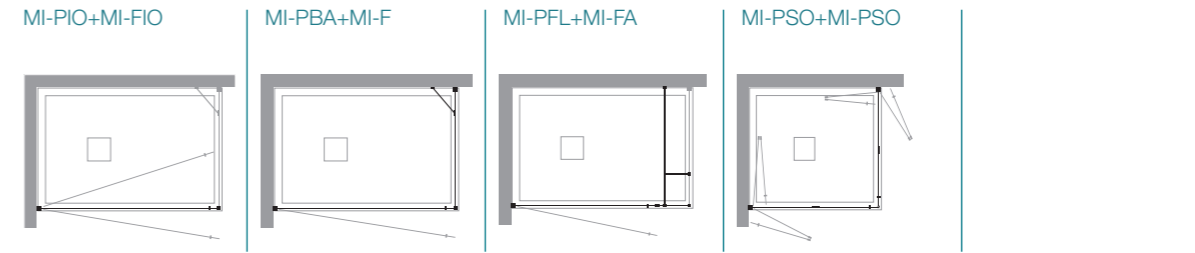

**ad angolo**



**installazioni particolari**

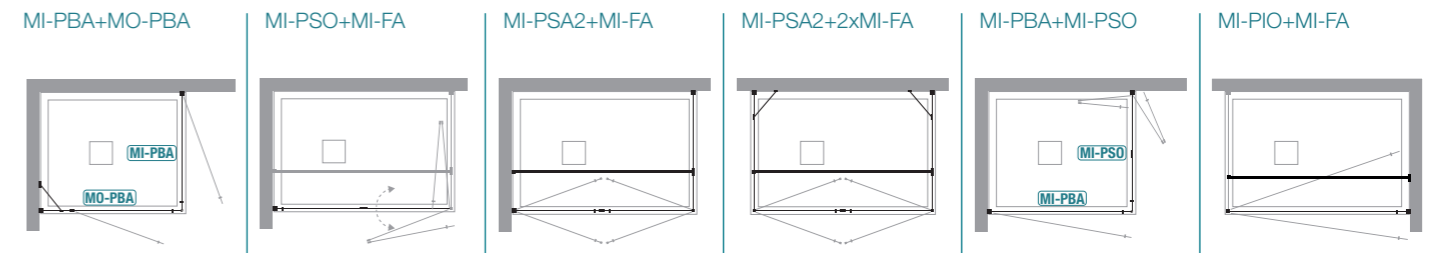

**profili**

**profiles**

per/for **MI: PIO-PBA-PSO-PFL-PSA2**

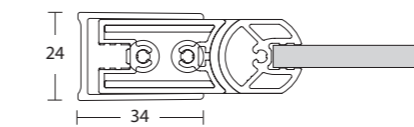

profilo a muro 1125 + schienale 1212  
wall profile 1125 + vertical profile 1212

per/for **MI-PIO**

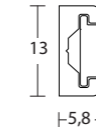

chiusura con magnete 1293  
magnetic closing 1293

per/for **MI-PBA**



chiusura con magnete 1128  
magnetic closing 1128

**importante**

**important**

ordini per pareti doccia speciali senza relativo disegno **NON** vengono prodotti

orders for special shower walls without related design are **NOT** produced

per installazioni particolari richiedere fattibilità. Alcune configurazioni necessitano di elementi aggiuntivi

contact TDA technical office for particular installation. More elements could be needed

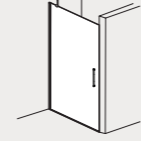

incluso      included



disponibile      available



### installazioni

in nicchia    niche  
**MI-PIO**

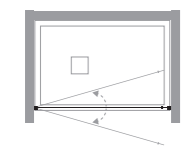

### installations

ad angolo    corner  
**MI-PIO+MI-FIO**

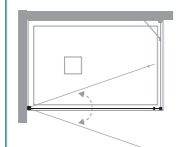

ad angolo    corner  
**MI-PIO+MI-FA**

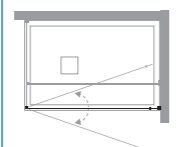

### informazioni

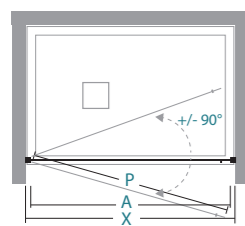

apertura battente IN/  
OUT  
IN/OUT swing door

**X** lunghezza parete doccia \ shower wall length  
**A** spazio d'entrata \ entrance space  
**P** lunghezza porta \ door length

### informations

|  | X     | A  | P  |  |  |  |  |   |    |
|--|-------|----|----|--|--|--|--|---|----|
|  | 37-39 | 30 | 31 |  |  |  |  | 1 | 17 |
|  | 42-44 | 35 | 36 |  |  |  |  | 1 | 19 |
|  | 47-49 | 40 | 41 |  |  |  |  | 1 | 20 |
|  | 52-54 | 45 | 46 |  |  |  |  | 1 | 22 |
|  | 57-59 | 50 | 51 |  |  |  |  | 1 | 23 |
|  | 62-64 | 55 | 56 |  |  |  |  | 1 | 25 |
|  | 67-69 | 60 | 61 |  |  |  |  | 1 | 27 |
|  | 72-74 | 65 | 66 |  |  |  |  | 1 | 28 |
|  | 77-79 | 70 | 71 |  |  |  |  | 1 | 30 |
|  | 87-89 | 80 | 81 |  |  |  |  | 1 | 33 |

### Misure standard

### Standard sizes

| Codice<br>Code | estensibilità<br>extension | Finiture profili<br>Profiles finishing | 30 | 32 | 16 | 29 | 28 | 12 |
|----------------|----------------------------|--|----|----|----|----|----|----|
| 08A220040      | 37-39                      | origin<br>abibat<br>vogue              |    |    |    |    |    |    |
| 08A220045      | 42-44                      | origin<br>abibat<br>vogue              |    |    |    |    |    |    |
| 08A220050      | 47-49                      | origin<br>abibat<br>vogue              |    |    |    |    |    |    |
| 08A220055      | 52-54                      | origin<br>abibat<br>vogue              |    |    |    |    |    |    |
| 08A220060      | 57-59                      | origin<br>abibat<br>vogue              |    |    |    |    |    |    |
| 08A220065      | 62-64                      | origin<br>abibat<br>vogue              |    |    |    |    |    |    |
| 08A220070      | 67-69                      | origin<br>abibat<br>vogue              |    |    |    |    |    |    |
| 08A220075      | 72-74                      | origin<br>abibat<br>vogue              |    |    |    |    |    |    |
| 08A220080      | 77-79                      | origin<br>abibat<br>vogue              |    |    |    |    |    |    |
| 08A220090      | 87-89                      | origin<br>abibat<br>vogue              |    |    |    |    |    |    |

### Misure speciali L / H

### Special sizes L / H

| Codice<br>Code | su misura<br>bespoke | Finiture profili<br>Profiles finishing | 30 | 32 | 16 | 29 | 28 | 27 | 12 |
|----------------|----------------------|--|----|----|----|----|----|----|----|
| 08A229001      | 19 < L < 40          | origin<br>abibat<br>vogue              |    |    |    |    |    |    |    |
| 08A229001      | 41 < L < 60          | origin<br>abibat<br>vogue              |    |    |    |    |    |    |    |
| 08A229001      | 61 < L < 90          | origin<br>abibat<br>vogue              |    |    |    |    |    |    |    |
| 08A229001      | 91 < L < 100         | origin<br>abibat<br>vogue              |    |    |    |    |    |    |    |

### attenzione

Il prezzo della H speciale va trovato nella tabella Misure speciali L / H in base alla L della parete doccia

Special price for H is to be found in **Special sizes L / H** as per L needed size

### warning

Optical e Terra - decografia per: vetro Trasparente e Fumè, Misure standard e speciali, max L 135 cm

Optical and Terra - decoprinting for: glass Transparente and Fumè, Standard and Special sizes, max L 135 cm

Specificare se installato a pavimento

Specify any floor installation

La lunghezza della porta MI-PIO abbinata a MI-FIO aumenta di 1,3 cm

Total lenght of MI-PIO combined with MI-FIO is 1,3 cm longer

Approfondimenti  
Insights



|   |     |
|---|-----|
| Indice<br>Index                           | 3   |
| Legenda simboli<br>Icons legend           | 11  |
| Profili - Vetri<br>Profiles - Glasses     | 21  |
| Ricambi<br>Spare parts                    | 406 |
| Profili speciali<br>Special profiles      | 434 |
| Schede rilievo misure<br>Measurement form | 444 |

Misure speciali  
Special size

|              |        |
|--------------|--------|
| <b>H</b> max | 210 cm |
| <b>L</b> min | 19 cm  |
| <b>L</b> max | 100 cm |

Disponibilità  
Availability

■ STOCK    Tcrom®

### supplementi

Profilo di compensazione 2 cm  
Extension profile 2 cm

Decografia  
Decoprinting

Sigillante SPARTAN®  
Sealant SPARTAN®

37P019221 per codice  
for code

36B010010

|                |       |        |          |       |       |      |      |            |      |             |              |          |            |
|----------------|-------|--------|----------|-------|-------|------|------|------------|------|-------------|--------------|----------|------------|
| 05             | 11    | 12     | 16       | 24    | 25    | 26   | 27   | 28         | 29   | 30          | 31           | 32       | 34         |
| acrilico satin | flack | reflex | satinato | nigol | flute | wave | alou | fumè brown | fumè | trasparente | extrachiario | cincilla | stampato C |

**origin** 59 Nero / 60 Bianco      **abibat** 27 Tcrom® / 21 Tinox® / 22 Tbronz®      **vogue** 61 Orosatinato / 62 Ororosa / 63 Cromonero / 64 Franciacorta / 65 Rame / 66 Brownie / Colori

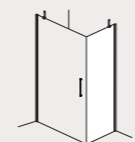

incluso

included



disponibile

available

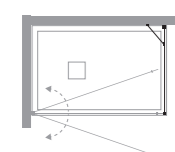

## installazioni

ad angolo corner  
MI-FIO+MI-PIO

## informazioni

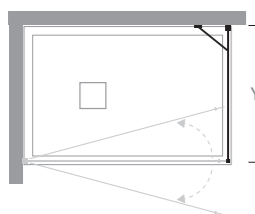

Y lunghezza parete doccia\ shower wall length

## installations

## informations

| Y           |  |  |  |  |  |  |  |  |  |   |    |
|-------------|--|--|--|--|--|--|--|--|--|---|----|
| 66,5-68,5   |  |  |  |  |  |  |  |  |  | 1 | 27 |
| 71,5-73,5   |  |  |  |  |  |  |  |  |  | 1 | 28 |
| 76,5-78,5   |  |  |  |  |  |  |  |  |  | 1 | 29 |
| 86,5-88,5   |  |  |  |  |  |  |  |  |  | 1 | 32 |
| 96,5-98,5   |  |  |  |  |  |  |  |  |  | 1 | 35 |
| 116,5-118,5 |  |  |  |  |  |  |  |  |  | 1 | 42 |

## Misure standard

## Standard sizes

| Codice<br>Code | estensibilità<br>extension | Finiture profili<br>Profiles finishing | 30 | 32 | 16 | 29 | 28 | 12 |
|----------------|----------------------------|--|----|----|----|----|----|----|
| 08F030070      | 66,5-68,5                  | origin<br>abitat<br>vogue              |    |    |    |    |    |    |
| 08F030075      | 71,5-73,5                  | origin<br>abitat<br>vogue              |    |    |    |    |    |    |
| 08F030080      | 76,5-78,5                  | origin<br>abitat<br>vogue              |    |    |    |    |    |    |
| 08F030090      | 86,5-88,5                  | origin<br>abitat<br>vogue              |    |    |    |    |    |    |
| 08F030100      | 96,5-98,5                  | origin<br>abitat<br>vogue              |    |    |    |    |    |    |
| 08F030120      | 116,5-118,5                | origin<br>abitat<br>vogue              |    |    |    |    |    |    |

## Misure speciali L / H

## Special sizes L / H

| Codice<br>Code | su misura<br>bespoke | Finiture profili<br>Profiles finishing | 30 | 32 | 16 | 29 | 28 | 27 | 12 |
|----------------|----------------------|--|----|----|----|----|----|----|----|
| 08F039001      | 12 < L < 40          | origin<br>abitat<br>vogue              |    |    |    |    |    |    |    |
| 08F039001      | 41 < L < 60          | origin<br>abitat<br>vogue              |    |    |    |    |    |    |    |
| 08F039001      | 61 < L < 90          | origin<br>abitat<br>vogue              |    |    |    |    |    |    |    |
| 08F039001      | 91 < L < 120         | origin<br>abitat<br>vogue              |    |    |    |    |    |    |    |
| 08F039001      | 121 < L < 150        | origin<br>abitat<br>vogue              |    |    |    |    |    |    |    |
| 08F039001      | 151 < L < 180        | origin<br>abitat<br>vogue              |    |    |    |    |    |    |    |

## attenzione

Il prezzo della H speciale va trovato nella tabella Misure speciali L / H in base alla L della parete doccia

Special price for H is to be found in Special sizes L / H as per L needed size

## warning

Optical e Terra - decografia per: vetro Trasparente e Fumè, Misure standard e speciali, max L 135 cm

Optical and Terra - decopyrinting for: glass Trasparente and Fumè, Standard and Special sizes, max L 135 cm

Incluso: supporto di rinforzo regolabile e snodato

Included: adjustable, articulated supporting bar

Misure speciali  
Special sizeDisponibilità  
Availability

|       |        |  |       |        |
|-------|--------|--|-------|--------|
| H max | 210 cm |  | STOCK | Tcrom® |
| L min | 12 cm  |  |       |        |
| L max | 180 cm |  |       |        |

## supplementi

## supplements

|   |                             |   |   |  |  |  |  |  |  |
|---|-----------------------------|---|---|--|--|--|--|--|--|
| Profilo di compensazione 2 cm<br>Extension profile 2 cm | Decografia<br>Decopyrinting | Sigillante SPARTAN®<br>Sealant SPARTAN® |   |  |  |  |  |  |  |
|   | €                           | €                                       | € |  |  |  |  |  |  |
| 37P019221   | per codice<br>for code      | 36B010010                               |   |  |  |  |  |  |  |

Approfondimenti  
Insights

|   |     |
|---|-----|
| Indice<br>Index                           | 3   |
| Legenda simboli<br>Icons legend           | 11  |
| Profili - Vetri<br>Profiles - Glasses     | 21  |
| Ricambi<br>Spare parts                    | 406 |
| Profili speciali<br>Special profiles      | 434 |
| Schede rilievo misure<br>Measurement form | 444 |

|                               |                                    |              |                |  |             |            |             |                  |            |                   |                   |                |                  |
|-------------------------------|------------------------------------|--------------|----------------|--|-------------|------------|-------------|------------------|------------|-------------------|-------------------|----------------|------------------|
| 05<br>acrilico satin<br>flack | 11<br>reflex                       | 12<br>reflex | 16<br>satinato | 24<br>nigol  | 25<br>flute | 26<br>wave | 27<br>alton | 28<br>fumè brown | 29<br>fumè | 30<br>trasparente | 31<br>extrachiaro | 32<br>cincillà | 34<br>stampato C |
| origin                        | abitat                             |              |                | vogue  |             |            |             |                  |            |                   |                   |                |                  |
| 59 Nero / 60 Bianco           | 27 Tcrom® / 21 Tinox® / 22 TbronZ® |              |                | 61 Orosatinato / 62 Ororosa / 63 Cromonero / 64 Franciacorta / 65 Rame / 66 Brownie / Colori |             |            |             |                  |            |                   |                   |                |                  |



incluso      included

disponibile      available

installazioni

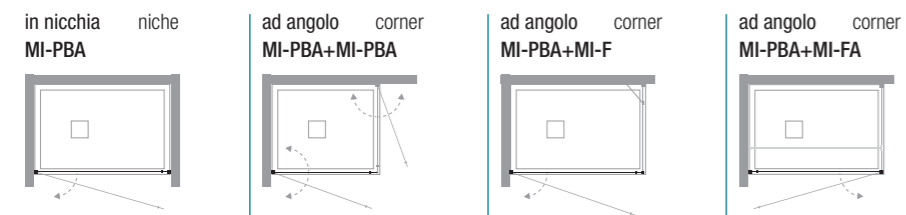

informazioni

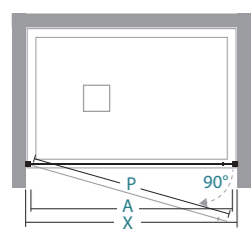

informations

apertura battente  
swing door

|  | X         | A  | P  |  |  |  |  |  |  |   |    |
|--|-----------|----|----|--|--|--|--|--|--|---|----|
|  | 37,5-39,5 | 30 | 31 |  |  |  |  |  |  |   |    |
|  | 42,5-44,5 | 35 | 36 |  |  |  |  |  |  | 1 | 20 |
|  | 47,5-49,5 | 40 | 41 |  |  |  |  |  |  | 1 | 21 |
|  | 52,5-54,5 | 45 | 46 |  |  |  |  |  |  | 1 | 23 |
|  | 57,5-59,5 | 50 | 51 |  |  |  |  |  |  | 1 | 24 |
|  | 62,5-64,5 | 55 | 56 |  |  |  |  |  |  | 1 | 26 |
|  | 67,5-69,5 | 60 | 61 |  |  |  |  |  |  | 1 | 28 |
|  | 72,5-74,5 | 65 | 66 |  |  |  |  |  |  | 1 | 29 |
|  | 77,5-79,5 | 70 | 71 |  |  |  |  |  |  | 1 | 31 |
|  | 87,5-89,5 | 80 | 81 |  |  |  |  |  |  | 1 | 34 |

X lunghezza parete doccia \ shower wall length  
A spazio d'entrata \ entrance space  
P lunghezza porta \ door length

Misure standard

| Codice<br>Code | estensibilità<br>extension | Finiture profili<br>Profiles finishing | 30 | 32 | 16 | 29 | 28 | 12 |
|----------------|----------------------------|--|----|----|----|----|----|----|
| 08A210040      | 37,5-39,5                  | origin<br>abitat<br>vogue              |    |    |    |    |    |    |
| 08A210045      | 42,5-44,5                  | origin<br>abitat<br>vogue              |    |    |    |    |    |    |
| 08A210050      | 47,5-49,5                  | origin<br>abitat<br>vogue              |    |    |    |    |    |    |
| 08A210055      | 52,5-54,5                  | origin<br>abitat<br>vogue              |    |    |    |    |    |    |
| 08A210060      | 57,5-59,5                  | origin<br>abitat<br>vogue              |    |    |    |    |    |    |
| 08A210065      | 62,5-64,5                  | origin<br>abitat<br>vogue              |    |    |    |    |    |    |
| 08A210070      | 67,5-69,5                  | origin<br>abitat<br>vogue              |    |    |    |    |    |    |
| 08A210075      | 72,5-74,5                  | origin<br>abitat<br>vogue              |    |    |    |    |    |    |
| 08A210080      | 77,5-79,5                  | origin<br>abitat<br>vogue              |    |    |    |    |    |    |
| 08A210090      | 87,5-89,5                  | origin<br>abitat<br>vogue              |    |    |    |    |    |    |

Misure speciali L / H

| Codice<br>Code | su misura<br>bespoke | Finiture profili<br>Profiles finishing | 30 | 32 | 16 | 29 | 28 | 27 | 12 |
|----------------|----------------------|--|----|----|----|----|----|----|----|
| 08A219001      | 19 < L < 40          | origin<br>abitat<br>vogue              |    |    |    |    |    |    |    |
| 08A219001      | 41 < L < 60          | origin<br>abitat<br>vogue              |    |    |    |    |    |    |    |
| 08A219001      | 61 < L < 90          | origin<br>abitat<br>vogue              |    |    |    |    |    |    |    |
| 08A219001      | 91 < L < 100         | origin<br>abitat<br>vogue              |    |    |    |    |    |    |    |

attenzione

Il prezzo della H speciale va trovato nella tabella Misure speciali L / H in base alla L della parete doccia

Special price for H is to be found in Special sizes L / H as per L needed size

warning

Optical e Terra - decografia per: vetro Trasparente e Fumè, Misure standard e speciali, max L 135 cm

Optical and Terra - decoprinting for: glass Trasparente and Fumè, Standard and Special sizes, max L 135 cm

Specificare se installato a pavimento

Specify any floor installation

Misure speciali  
Special size

|   |     |        |
|---|-----|--------|
| H | max | 210 cm |
| L | min | 19 cm  |
| L | max | 100 cm |

Disponibilità  
Availability

■ STOCK Tcrom®

supplementi

Profilo di compensazione 2 cm  
Extension profile 2 cm

Decografia  
Decoprinting

supplements

Sigillante SPARTAN®  
Sealant SPARTAN®

37P019221

per codice  
for code

36B010010

|                |       |        |          |       |       |      |      |            |      |             |             |          |            |
|----------------|-------|--------|----------|-------|-------|------|------|------------|------|-------------|-------------|----------|------------|
| 05             | 11    | 12     | 16       | 24    | 25    | 26   | 27   | 28         | 29   | 30          | 31          | 32       | 34         |
| acrilico satin | flack | reflex | satinato | nigol | flute | wave | alou | fumè brown | fumè | trasparente | extrachiaro | cincillà | stampato C |

origin      abitat      vogue

59 Nero / 60 Bianco      27 Tcrom® / 21 Tinox® / 22 Tbronze®      61 Orosatinato / 62 Ororosa / 63 Cromonero / 64 Franciacorta / 65 Rame / 66 Brownie / Colori

Approfondimenti  
Insights





|   |     |
|---|-----|
| Indice<br>Index                           | 3   |
| Legenda simboli<br>Icons legend           | 11  |
| Profili - Vetri<br>Profiles - Glasses     | 21  |
| Ricambi<br>Spare parts                    | 406 |
| Profili speciali<br>Special profiles      | 434 |
| Schede rilievo misure<br>Measurement form | 444 |



















incluso



included





disponibile

available

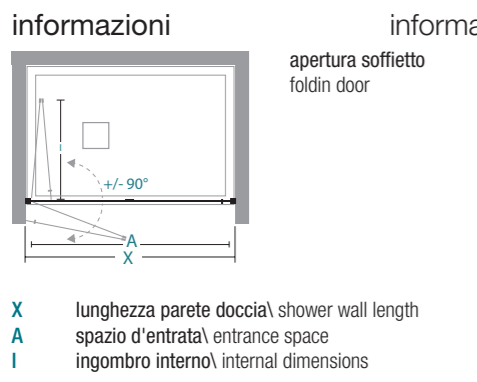
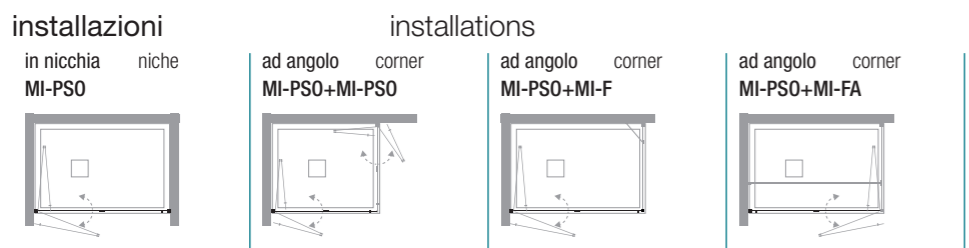

|           | X  | A    | I |  |  |  |  |   |    |
|-----------|----|------|---|--|--|--|--|---|----|
| 57,5-59,5 | 46 | 29   |   |  |  |  |  | 1 | 24 |
| 62,5-64,5 | 51 | 31,5 |   |  |  |  |  | 1 | 26 |
| 67,5-69,5 | 56 | 34   |   |  |  |  |  | 1 | 28 |
| 72,5-74,5 | 61 | 36,5 |   |  |  |  |  | 1 | 29 |
| 77,5-79,5 | 66 | 39   |   |  |  |  |  | 1 | 31 |
| 82,5-84,5 | 71 | 41,5 |   |  |  |  |  | 1 | 33 |
| 87,5-89,5 | 76 | 44   |   |  |  |  |  | 1 | 34 |
| 92,5-94,5 | 81 | 46,5 |   |  |  |  |  | 1 | 36 |
| 97,5-99,5 | 86 | 49   |   |  |  |  |  | 1 | 38 |

| Misure standard |                         | Standard sizes                      |    |    |    |    |    |    |
|-----------------|-------------------------|-------------------------------------|----|----|----|----|----|----|
| Codice Code     | estensibilità extension | Finiture profili Profiles finishing | 30 | 32 | 16 | 29 | 28 | 12 |
| 08P220060       | 57,5-59,5               | origin<br>abitat<br>vogue           |    |    |    |    |    |    |
| 08P220065       | 62,5-64,5               | origin<br>abitat<br>vogue           |    |    |    |    |    |    |
| 08P220070       | 67,5-69,5               | origin<br>abitat<br>vogue           |    |    |    |    |    |    |
| 08P220075       | 72,5-74,5               | origin<br>abitat<br>vogue           |    |    |    |    |    |    |
| 08P220080       | 77,5-79,5               | origin<br>abitat<br>vogue           |    |    |    |    |    |    |
| 08P220085       | 82,5-84,5               | origin<br>abitat<br>vogue           |    |    |    |    |    |    |
| 08P220090       | 87,5-89,5               | origin<br>abitat<br>vogue           |    |    |    |    |    |    |
| 08P220095       | 92,5-94,5               | origin<br>abitat<br>vogue           |    |    |    |    |    |    |
| 08P220100       | 97,5-99,5               | origin<br>abitat<br>vogue           |    |    |    |    |    |    |

| Misure speciali L / H |                         | Special sizes L / H                 |    |    |    |    |    |    |    |
|-----------------------|-------------------------|-------------------------------------|----|----|----|----|----|----|----|
| Codice Code           | estensibilità extension | Finiture profili Profiles finishing | 30 | 32 | 16 | 29 | 28 | 27 | 12 |
| 08P229001             | 57 < L < 80             | origin<br>abitat<br>vogue           |    |    |    |    |    |    |    |
| 08P229001             | 81 < L < 90             | origin<br>abitat<br>vogue           |    |    |    |    |    |    |    |
| 08P229001             | 91 < L < 100            | origin<br>abitat<br>vogue           |    |    |    |    |    |    |    |

**attenzione** Il prezzo della H speciale va trovato nella tabella Misure speciali L / H in base alla L della parete doccia

**warning** Specify any floor installation

Optical e Terra - decografia per: vetro Trasparente e Fumè, Misure standard e speciali, max L 135 cm

Optical and Terra - decoprinting for: glass Trasparente and Fumè, Standard and Special sizes, max L 135 cm

| Misure speciali Special size | Disponibilità Availability |       |        |  |  |  |  |  |  |
|------------------------------|----------------------------|-------|--------|--|--|--|--|--|--|
| H max 210 cm                 |                            | STOCK | Tcrom® |  |  |  |  |  |  |
| L min 57 cm                  |                            |       |        |  |  |  |  |  |  |
| L max 100 cm                 |                            |       |        |  |  |  |  |  |  |

**supplementi**

| Profilo di compensazione 2 cm Extension profile 2 cm | Decografia Decoprinting | Sigillante SPARTAN® Sealant SPARTAN® |           |  |  |  |  |  |  |
|--|-------------------------|--------------------------------------|-----------|--|--|--|--|--|--|
| 37P019221  | €                       | €                                    | €         |  |  |  |  |  |  |
|  | per codice for code     |                                      | 36B010010 |  |  |  |  |  |  |

05 acrilico satin flack 11 reflex 12 satinato 16 nigol 24 flute 25 wave 26 aion 27 fumè brown fumè 28 trasparente 29 extrachiaro 30 cincillà 31 stampato C 32 34

origin abitat vogue

59 Nero / 60 Bianco 27 Tcrom® / 21 Tinox® / 22 Tbronzo® 61 Orosatinato / 62 Ororosa / 63 Cromonero / 64 Franciacorta / 65 Rame / 66 Brownie / Colori

**Approfondimenti Insights**



Indice Index 3

Legenda simboli Icons legend 11

Profili - Vetri Profiles - Glasses 21

Ricambi Spare parts 406



Profili speciali Special profiles 434



Schede rilievo misure Measurement form 444







incluso
included





disponibile
available

### installazioni

ad angolo corner  
MI-F+MI-PBA

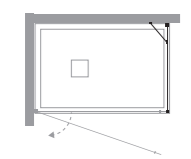

### installations

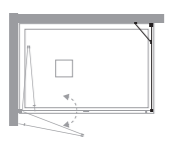

ad angolo corner  
MI-F+ MI-PSO

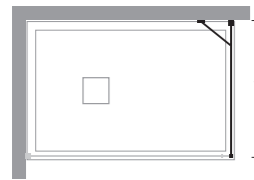

### informazioni



### informations

| Y           |  |  |  |  |  |  |  |  |  |  |  |
|-------------|--|--|--|--|--|--|--|--|--|---|---|
| 67,5-69,5   |  |  |  |  |  |  |  |  |  | 1   | 27  |
| 72,5-74,5   |  |  |  |  |  |  |  |  |  | 1   | 28  |
| 77,5-79,5   |  |  |  |  |  |  |  |  |  | 1   | 29  |
| 87,5-89,5   |  |  |  |  |  |  |  |  |  | 1   | 32  |
| 97,5-99,5   |  |  |  |  |  |  |  |  |  | 1   | 35  |
| 117,5-119,5 |  |  |  |  |  |  |  |  |  | 1   | 42  |

Y lunghezza parete doccia\ shower wall length

| Misure standard |                         | Standard sizes                      |    |    |    |    |    |    |
|-----------------|-------------------------|-------------------------------------|----|----|----|----|----|----|
| Codice Code     | estensibilità extension | Finiture profili Profiles finishing | 30 | 32 | 16 | 29 | 28 | 12 |
| 08F010070       | 67,5-69,5               | origin                              |    |    |    |    |    |    |
|                 |                         | abitat                              |    |    |    |    |    |    |
|                 |                         | vogue                               |    |    |    |    |    |    |
| 08F010075       | 72,5-74,5               | origin                              |    |    |    |    |    |    |
|                 |                         | abitat                              |    |    |    |    |    |    |
|                 |                         | vogue                               |    |    |    |    |    |    |
| 08F010080       | 77,5-79,5               | origin                              |    |    |    |    |    |    |
|                 |                         | abitat                              |    |    |    |    |    |    |
|                 |                         | vogue                               |    |    |    |    |    |    |
| 08F010090       | 87,5-89,5               | origin                              |    |    |    |    |    |    |
|                 |                         | abitat                              |    |    |    |    |    |    |
|                 |                         | vogue                               |    |    |    |    |    |    |
| 08F010100       | 97,5-99,5               | origin                              |    |    |    |    |    |    |
|                 |                         | abitat                              |    |    |    |    |    |    |
|                 |                         | vogue                               |    |    |    |    |    |    |
| 08F010120       | 117,5-119,5             | origin                              |    |    |    |    |    |    |
|                 |                         | abitat                              |    |    |    |    |    |    |
|                 |                         | vogue                               |    |    |    |    |    |    |

| Misure speciali L / H |                   | Special sizes L / H                 |    |    |    |    |    |    |    |
|-----------------------|-------------------|-------------------------------------|----|----|----|----|----|----|----|
| Codice Code           | su misura bespoke | Finiture profili Profiles finishing | 30 | 32 | 16 | 29 | 28 | 27 | 12 |
| 08F019001             | 12 < L < 40       | origin                              |    |    |    |    |    |    |    |
|                       |                   | abitat                              |    |    |    |    |    |    |    |
|                       |                   | vogue                               |    |    |    |    |    |    |    |
| 08F019001             | 41 < L < 60       | origin                              |    |    |    |    |    |    |    |
|                       |                   | abitat                              |    |    |    |    |    |    |    |
|                       |                   | vogue                               |    |    |    |    |    |    |    |
| 08F019001             | 61 < L < 90       | origin                              |    |    |    |    |    |    |    |
|                       |                   | abitat                              |    |    |    |    |    |    |    |
|                       |                   | vogue                               |    |    |    |    |    |    |    |
| 08F019001             | 91 < L < 120      | origin                              |    |    |    |    |    |    |    |
|                       |                   | abitat                              |    |    |    |    |    |    |    |
|                       |                   | vogue                               |    |    |    |    |    |    |    |
| 08F019001             | 121 < L < 150     | origin                              |    |    |    |    |    |    |    |
|                       |                   | abitat                              |    |    |    |    |    |    |    |
|                       |                   | vogue                               |    |    |    |    |    |    |    |
| 08F019001             | 151 < L < 180     | origin                              |    |    |    |    |    |    |    |
|                       |                   | abitat                              |    |    |    |    |    |    |    |
|                       |                   | vogue                               |    |    |    |    |    |    |    |

### attenzione

Il prezzo della H speciale va trovato nella tabella Misure speciali L / H in base alla L della parete doccia

Special price for H is to be found in Special sizes L / H as per L needed size

### warning

Optical e Terra - decografia per: vetro Trasparente e Fumè, Misure standard e speciali, max L 135 cm

Optical and Terra - decoprinting for: glass Trasparente and Fumè, Standard and Special sizes, max L 135 cm

Incluso: supporto di rinforzo regolabile e snodato

Included: adjustable, articulated supporting bar

| Misure speciali Special size                            | Disponibilità Availability   |                                      |  |  |  |  |  |  |  |  |
|---|--|--------------------------------------|--|--|--|--|--|--|--|--|
| H max 210 cm  |  STOCK Tcrom® |                                      |  |  |  |  |  |  |  |  |
| L min 12 cm   |  |                                      |  |  |  |  |  |  |  |  |
| L max 180 cm  |  |                                      |  |  |  |  |  |  |  |  |
| Profilo di compensazione 2 cm<br>Extension profile 2 cm | Decografia Decoprinting  | Sigillante SPARTAN® Sealant SPARTAN® |  |  |  |  |  |  |  |  |
| 37P019221   | per codice for code  | 36B010010                            |  |  |  |  |  |  |  |  |

Approfondimenti Insights



|  |     |
|--|-----|
| Indice Index                           | 3   |
| Legenda simboli Icons legend           | 11  |
| Profili - Vetri Profiles - Glasses     | 21  |
| Ricambi Spare parts                    | 406 |
| Profili speciali Special profiles      | 434 |
| Schede rilievo misure Measurement form | 444 |

| 05             | 11    | 12     | 16       | 24    | 25    | 26   | 27    | 28         | 29   | 30          | 31           | 32       | 34         |
|----------------|-------|--------|----------|-------|-------|------|-------|------------|------|-------------|--------------|----------|------------|
| acrilico satin | flack | reflex | satinato | nigol | flute | wave | alon  | fumè brown | fumè | trasparente | extrachiario | cincillà | stampato C |
| origin         |       |        | abitat   |       |       |      | vogue |            |      |             |              |          |            |

59 Nero / 60 Bianco 27 Tcrom® / 21 Tinox® / 22 Tbronz® 61 Orosatinato / 62 Ororosa / 63 Cromonero / 64 Franciacorta / 65 Rame / 66 Brownie / Colori



incluso

included



disponibile

available



installazioni

in nicchia niche

MI-PFL

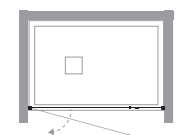

installations

ad angolo corner

MI-PFL+MI-FA

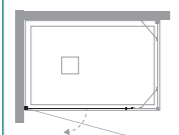

informazioni

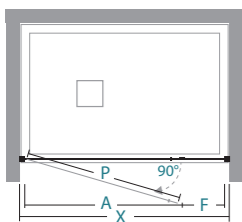

informations

apertura battente swing door

|         | X  | A  | P    | F |  |  |  |  |   |    |
|---------|----|----|------|---|--|--|--|--|---|----|
| 96-100  | 60 | 60 | 29,5 |   |  |  |  |  | 2 | 37 |
| 106-110 | 60 | 60 | 39,5 |   |  |  |  |  | 2 | 41 |
| 116-120 | 70 | 70 | 39,5 |   |  |  |  |  | 2 | 44 |
| 126-130 | 70 | 70 | 49,5 |   |  |  |  |  | 2 | 47 |
| 136-140 | 80 | 80 | 49,5 |   |  |  |  |  | 2 | 51 |
| 146-150 | 80 | 80 | 59,5 |   |  |  |  |  | 2 | 54 |

- X lunghezza parete doccia\ shower wall length
- A spazio d'entrata\ entrance space
- P lunghezza porta\ door length
- F lunghezza lato fisso\ fixed side length

Misure standard

Standard sizes

| Codice Code | estensibilità extension | Finiture profili Profiles finishing | 30 | 32 | 16 | 29 | 28 | 12 |
|-------------|-------------------------|-------------------------------------|----|----|----|----|----|----|
| 08P230100   | 96-100                  | origin<br>abitat<br>vogue           |    |    |    |    |    |    |
| 08P230110   | 106-110                 | origin<br>abitat<br>vogue           |    |    |    |    |    |    |
| 08P230120   | 116-120                 | origin<br>abitat<br>vogue           |    |    |    |    |    |    |
| 08P230130   | 126-130                 | origin<br>abitat<br>vogue           |    |    |    |    |    |    |
| 08P230140   | 136-140                 | origin<br>abitat<br>vogue           |    |    |    |    |    |    |
| 08P230150   | 146-150                 | origin<br>abitat<br>vogue           |    |    |    |    |    |    |

Misure speciali L / H

Special sizes L / H

| Codice Code | su misura bespoke | Finiture profili Profiles finishing | 30 | 32 | 16 | 29 | 28 | 27 | 12 |
|-------------|-------------------|-------------------------------------|----|----|----|----|----|----|----|
| 08P239001   | 70 < L < 100      | origin<br>abitat<br>vogue           |    |    |    |    |    |    |    |
| 08P239001   | 101 < L < 120     | origin<br>abitat<br>vogue           |    |    |    |    |    |    |    |
| 08P239001   | 121 < L < 140     | origin<br>abitat<br>vogue           |    |    |    |    |    |    |    |
| 08P239001   | 141 < L < 160     | origin<br>abitat<br>vogue           |    |    |    |    |    |    |    |
| 08P239001   | 161 < L < 180     | origin<br>abitat<br>vogue           |    |    |    |    |    |    |    |
| 08P239001   | 181 < L < 200     | origin<br>abitat<br>vogue           |    |    |    |    |    |    |    |

attenzione

Il prezzo della H speciale va trovato nella tabella Misure speciali L / H in base alla L della parete doccia

Special price for H is to be found in Special sizes L / H as per L needed size

warning

Optical e Terra - decografia per: vetro Trasparente e Fumè, Misure standard e speciali, max L 135 cm

Optical and Terra - decoprinting for: glass Trasparente and Fumè, Standard and Special sizes, max L 135 cm

Incluso: supporto di rinforzo regolabile e snodato

Included: adjustable, articulated supporting bar

Specificare se installato a pavimento

Specify any floor installation

Per ottenere l'apertura IN/OUT sostituire la guarnizione in dotazione con la guarnizione cod. 37R019327

For IN/OUT installation substitute the included seal with seal code 37R019327

Approfondimenti Insights



|  |     |
|--|-----|
| Indice Index                           | 3   |
| Legenda simboli Icons legend           | 11  |
| Profili - Vetri Profiles - Glasses     | 21  |
| Ricambi Spare parts                    | 406 |
| Profili speciali Special profiles      | 434 |
| Schede rilievo misure Measurement form | 444 |

Misure speciali Special size

|       |        |
|-------|--------|
| H max | 210 cm |
| L min | 70 cm  |
| L max | 200 cm |

Disponibilità Availability

STOCK Tcrom®

supplementi

Profilo di compensazione 2 cm Extension profile 2 cm

€

37P019221

supplements

Guarnizione IN/OUT Seal IN/OUT

€

37R019327

Decografia Decoprinting

per codice for code

€

36B010010

Sigillante SPARTAN® Sealant SPARTAN®

€

|                |       |        |          |       |       |      |      |            |      |             |              |          |            |
|----------------|-------|--------|----------|-------|-------|------|------|------------|------|-------------|--------------|----------|------------|
| 05             | 11    | 12     | 16       | 24    | 25    | 26   | 27   | 28         | 29   | 30          | 31           | 32       | 34         |
| acrilico satin | flack | reflex | satinato | nigol | flute | wave | alou | fumè brown | fumè | trasparente | extrachiario | cincillà | stampato C |

|                     |                                     |  |
|---------------------|-------------------------------------|--|
| origin              | abitat                              | vogue  |
| 59 Nero / 60 Bianco | 27 Tcrom® / 21 Tinox® / 22 Tbronze® | 61 Orosatinato / 62 Ororosa / 63 Cromonero / 64 Franciacorta / 65 Rame / 66 Brownie / Colori |



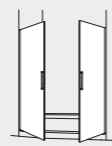

incluso      included

disponibile      available

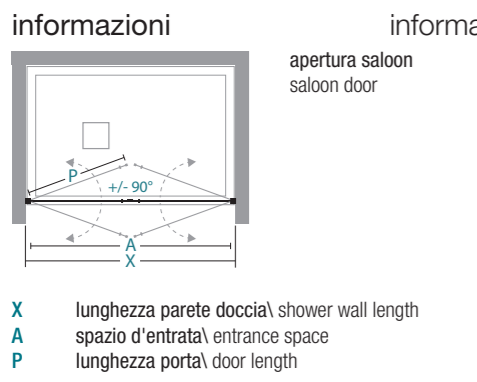
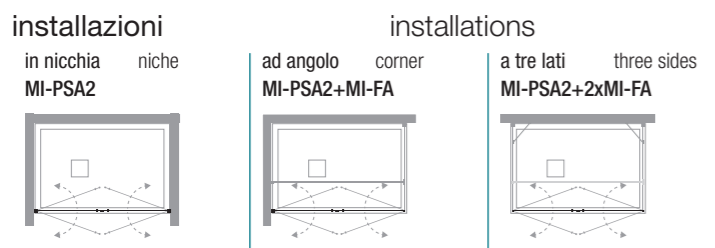

|             | X   | A  | P |  |  |  |  |  |   |    |
|-------------|-----|----|---|--|--|--|--|--|---|----|
| 66,5-70,5   | 54  | 28 |   |  |  |  |  |  | 1 | 26 |
| 71,5-75,5   | 59  | 31 |   |  |  |  |  |  | 1 | 27 |
| 76,5-80,5   | 64  | 33 |   |  |  |  |  |  | 1 | 29 |
| 86,5-90,5   | 74  | 38 |   |  |  |  |  |  | 1 | 32 |
| 96,5-100,5  | 84  | 43 |   |  |  |  |  |  | 2 | 36 |
| 106,5-110,5 | 94  | 48 |   |  |  |  |  |  | 2 | 40 |
| 116,5-120,5 | 104 | 53 |   |  |  |  |  |  | 2 | 43 |

**Misure standard**      Standard sizes

| Codice<br>Code | estensibilità<br>extension | Finiture profili<br>Profiles finishing | 30 | 32 | 16 | 29 | 28 | 12 |
|----------------|----------------------------|--|----|----|----|----|----|----|
| 08P210070      | 66,5-70,5                  | origin<br>abitat<br>vogue              |    |    |    |    |    |    |
| 08P210075      | 71,5-75,5                  | origin<br>abitat<br>vogue              |    |    |    |    |    |    |
| 08P210080      | 76,5-80,5                  | origin<br>abitat<br>vogue              |    |    |    |    |    |    |
| 08P210090      | 86,5-90,5                  | origin<br>abitat<br>vogue              |    |    |    |    |    |    |
| 08P210100      | 96,5-100,5                 | origin<br>abitat<br>vogue              |    |    |    |    |    |    |
| 08P210110      | 106,5-110,5                | origin<br>abitat<br>vogue              |    |    |    |    |    |    |
| 08P210120      | 116,5-120,5                | origin<br>abitat<br>vogue              |    |    |    |    |    |    |

**Misure speciali L / H**      Special sizes L / H

| Codice<br>Code | su misura<br>bespoke | Finiture profili<br>Profiles finishing | 30 | 32 | 16 | 29 | 28 | 27 | 12 |
|----------------|----------------------|--|----|----|----|----|----|----|----|
| 08P219001      | 50 < L < 80          | origin<br>abitat<br>vogue              |    |    |    |    |    |    |    |
| 08P219001      | 81 < L < 100         | origin<br>abitat<br>vogue              |    |    |    |    |    |    |    |
| 08P219001      | 101 < L < 120        | origin<br>abitat<br>vogue              |    |    |    |    |    |    |    |
| 08P219001      | 121 < L < 140        | origin<br>abitat<br>vogue              |    |    |    |    |    |    |    |
| 08P219001      | 141 < L < 160        | origin<br>abitat<br>vogue              |    |    |    |    |    |    |    |
| 08P219001      | 161 < L < 180        | origin<br>abitat<br>vogue              |    |    |    |    |    |    |    |

**attenzione**      warning

Il prezzo della H speciale va trovato nella tabella Misure speciali L / H in base alla L della parete doccia

Special price for H is to be found in **Special sizes L / H** as per L needed size

Optical e Terra - decografia per: vetro Trasparente e Fumè, Misure standard e speciali, max L 135 cm

Optical and Terra - decoprinting for: glass Trasparente and Fumè, Standard and Special sizes, max L 135 cm

Specificare se installato a pavimento

Specify any floor installation

Per installazioni ad angolo o a tre lati richiedere fattibilità. Obbligatorio il supporto 36S129001 se 3 lati

For corner or 3-sided installations please ask for feasibility. Support **36S129001** mandatory if 3-sided

| Misure speciali<br>Special size             | Disponibilità<br>Availability |        |  |  |
|---|-------------------------------|--------|--|--|
| H max 210 cm<br>L min 50 cm<br>L max 180 cm | STOCK                         | Tcrom® |  |  |

**supplementi**      supplements

| Profilo di compensazione 2 cm<br>Extension profile 2 cm | Decografia<br>Decoprinting | Sigillante SPARTAN®<br>Sealant SPARTAN® | Supporto di rinforzo speciale<br>Special supporting bar |
|---|----------------------------|---|---|
| 37P019221   | per codice<br>for code     | 36B010010                               | 36S129001   |

Approfondimenti  
Insights



|   |     |
|---|-----|
| Indice<br>Index                           | 3   |
| Legenda simboli<br>Icons legend           | 11  |
| Profili - Vetri<br>Profiles - Glasses     | 21  |
| Ricambi<br>Spare parts                    | 406 |
| Profili speciali<br>Special profiles      | 434 |
| Schede rilievo misure<br>Measurement form | 444 |

| 05                  | 11                                  | 12     | 16       | 24    | 25    | 26   | 27   | 28         | 29   | 30          | 31           | 32       | 34         |
|---------------------|-------------------------------------|--------|----------|-------|-------|--|------|------------|------|-------------|--------------|----------|------------|
| acrilico satin      | flack                               | reflex | satinato | nigol | flute | wave   | alon | fumè brown | fumè | trasparente | extrachiario | cincillà | stampato C |
| <b>origin</b>       | <b>abitat</b>                       |        |          |       |       | <b>vogue</b>   |      |            |      |             |              |          |            |
| 59 Nero / 60 Bianco | 27 Tcrom® / 21 Tinox® / 22 Tbronze® |        |          |       |       | 61 Orosatinato / 62 Ororosa / 63 Cromonero / 64 Franciacorta / 65 Rame / 66 Brownie / Colori |      |            |      |             |              |          |            |

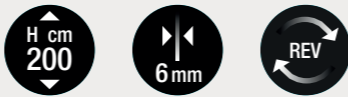
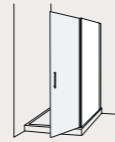

incluso included

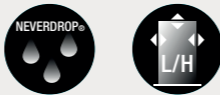

disponibile available



### installazioni

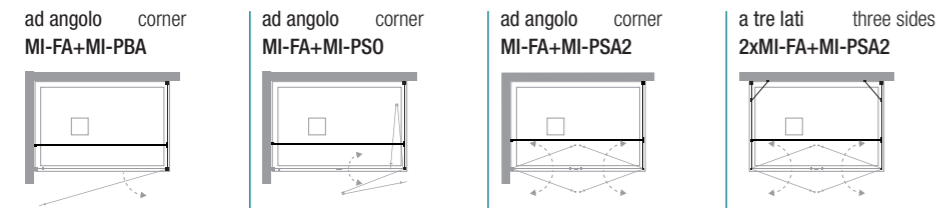

### informazioni

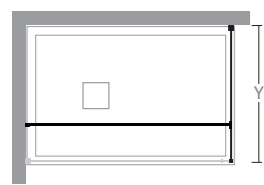

Y lunghezza parete doccia\ shower wall length

### installations

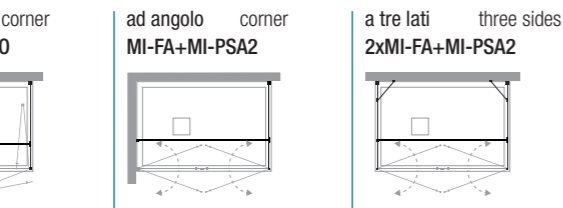

### informations

| Y           |  |  |  |  |   |    |
|-------------|--|--|--|--|---|----|
| 67,5-69,5   |  |  |  |  | 1 | 26 |
| 72,5-74,5   |  |  |  |  | 1 | 28 |
| 77,5-79,5   |  |  |  |  | 1 | 29 |
| 87,5-89,5   |  |  |  |  | 1 | 33 |
| 97,5-99,5   |  |  |  |  | 1 | 36 |
| 117,5-119,5 |  |  |  |  | 1 | 42 |

### Misure standard

### Standard sizes

| Codice Code | estensibilità extension | Finiture profili Profiles finishing | 30 | 32 | 16 | 29 | 28 | 12 |
|-------------|-------------------------|-------------------------------------|----|----|----|----|----|----|
| 08F020070   | 67,5-69,5               | origin                              |    |    |    |    |    |    |
|             |                         | abitat                              | ■  |    |    |    |    |    |
|             |                         | vogue                               |    |    |    |    |    |    |
| 08F020075   | 72,5-74,5               | origin                              |    |    |    |    |    |    |
|             |                         | abitat                              |    |    |    |    |    |    |
|             |                         | vogue                               |    |    |    |    |    |    |
| 08F020080   | 77,5-79,5               | origin                              |    |    |    |    |    |    |
|             |                         | abitat                              | ■  |    |    |    |    |    |
|             |                         | vogue                               |    |    |    |    |    |    |
| 08F020090   | 87,5-89,5               | origin                              |    |    |    |    |    |    |
|             |                         | abitat                              | ■  |    |    |    |    |    |
|             |                         | vogue                               |    |    |    |    |    |    |
| 08F020100   | 97,5-99,5               | origin                              |    |    |    |    |    |    |
|             |                         | abitat                              |    |    |    |    |    |    |
|             |                         | vogue                               |    |    |    |    |    |    |
| 08F020120   | 117,5-119,5             | origin                              |    |    |    |    |    |    |
|             |                         | abitat                              |    |    |    |    |    |    |
|             |                         | vogue                               |    |    |    |    |    |    |

### Misure speciali L / H

### Special sizes L / H

| Codice Code | su misura bespoke | Finiture profili Profiles finishing | 30 | 32 | 16 | 29 | 28 | 27 | 12 |
|-------------|-------------------|-------------------------------------|----|----|----|----|----|----|----|
| 08F029001   | 16 < L < 40       | origin                              |    |    |    |    |    |    |    |
|             |                   | abitat                              |    |    |    |    |    |    |    |
|             |                   | vogue                               |    |    |    |    |    |    |    |
| 08F029001   | 41 < L < 60       | origin                              |    |    |    |    |    |    |    |
|             |                   | abitat                              |    |    |    |    |    |    |    |
|             |                   | vogue                               |    |    |    |    |    |    |    |
| 08F029001   | 61 < L < 90       | origin                              |    |    |    |    |    |    |    |
|             |                   | abitat                              |    |    |    |    |    |    |    |
|             |                   | vogue                               |    |    |    |    |    |    |    |
| 08F029001   | 91 < L < 120      | origin                              |    |    |    |    |    |    |    |
|             |                   | abitat                              |    |    |    |    |    |    |    |
|             |                   | vogue                               |    |    |    |    |    |    |    |
| 08F029001   | 121 < L < 150     | origin                              |    |    |    |    |    |    |    |
|             |                   | abitat                              |    |    |    |    |    |    |    |
|             |                   | vogue                               |    |    |    |    |    |    |    |
| 08F029001   | 151 < L < 180     | origin                              |    |    |    |    |    |    |    |
|             |                   | abitat                              |    |    |    |    |    |    |    |
|             |                   | vogue                               |    |    |    |    |    |    |    |

### attenzione

Il prezzo della H speciale va trovato nella tabella Misure speciali L / H in base alla L della parete doccia

Special price for H is to be found in Special sizes L / H as per L needed size

| Misure speciali Special size | Disponibilità Availability |        |
|------------------------------|----------------------------|--------|
| H max 210 cm                 | ■ STOCK                    | Tcrom® |
| L min 16 cm                  |                            |        |
| L max 180 cm                 |                            |        |

### supplementi

Profilo di compensazione 2 cm Extension profile 2 cm

| €         |                     | €         |  | € |
|-----------|---------------------|-----------|--|---|
| 37P019221 | per codice for code | 36B010010 |  |   |

### warning

Optical e Terra - decografia per: vetro Trasparente e Fumè, Misure standard e speciali, max L 135 cm

Optical and Terra - decoprinting for: glass Trasparente and Fumè, Standard and Special sizes, max L 135 cm

Incluso: supporto di rinforzo regolabile e snodato + supporto fisso

Included: adjustable, articulated supporting bar + fixed supporting bar

Per installazioni ad angolo o a tre lati richiedere fattibilità. Alcune configurazioni necessitano di elementi aggiuntivi

Contact TDA technical office for corner or three sides installation. More elements could be needed

### supplements

Sigillante SPARTAN® Sealant SPARTAN®

| € |  | € |
|---|--|---|
|   |  |   |

### Approfondimenti Insights



|  |     |
|--|-----|
| Indice Index                           | 3   |
| Legenda simboli Icons legend           | 11  |
| Profili - Vetri Profiles - Glasses     | 21  |
| Ricambi Spare parts                    | 406 |
| Profili speciali Special profiles      | 434 |
| Schede rilievo misure Measurement form | 444 |

| 05             | 11    | 12     | 16       | 24    | 25    | 26   | 27   | 28         | 29   | 30          | 31          | 32       | 34         |
|----------------|-------|--------|----------|-------|-------|------|------|------------|------|-------------|-------------|----------|------------|
| acrilico satin | flack | reflex | satinato | nigol | flute | wave | aion | fumè brown | fumè | trasparente | extrachiaro | cincillà | stampato C |

| origin              | abitat                              | vogue  |
|---------------------|-------------------------------------|--|
| 59 Nero / 60 Bianco | 27 Tcrom® / 21 Tinox® / 22 Tbronzo® | 61 Orosatinato / 62 Ororosa / 63 Cromonero / 64 Franciacorta / 65 Rame / 66 Brownie / Colori |



Porta a soffietto girevole installazione ad angolo  
profilo Tcrom® / vetro Trasparente  
Piatto doccia ARTURO

Folding and pivoting door corner installation  
Tcrom® profile / Transparent glass  
Shower tray ARTURO

## VOLO

Le porte a soffietto con apertura totale sono caratteristica essenziale del design di questa serie; annullano qualsiasi barriera anche per un uso con mobilità ridotta (PMR). La versatilità come primo obiettivo. Una serie che ben si adatta a ogni esigenza di spazio e stile. Minimo ingombro e design rigoroso per le cerniere a camma realizzate in lega metallica. Un passe-partout di carattere immediato e lineare dove la presenza dei profili è minima per la massima dimensione di ingresso

The folding doors providing a full opening are an essential feature of the design of this series; they eliminate any barrier even for use with reduced mobility (PMR). Versatility as the primary objective. A series that adapts well to every space and style requirement. Minimal space required and stern design for the cam hinges made of metal alloy. A versatile solution with an immediate and linear character where the presence of profiles is minimal to optimize the space to enter the shower



01



02



03



04



05



06

**01** doppia maniglia cromata con paracolpo interasse 16 cm | **02** maniglia con sistema a sgancio per modelli PMR | **03** cerniera 180° su profilo a muro | **04** cerniera vetro/vetro per apertura ad ala di gabbiano | **05** sostegno di supporto | **06** tappi per profili verticali in finitura cromata |

**01** double chrome handle with shock absorber and interaxe 16 cm | **02** handle with quick realease system for PMR shower enclosures | **03** 180° hinge on wall profile | **04** glass-to-glass hinge for gull-wing opening | **05** support bracket | **06** chrome caps for vertical profiles |



Finiture profili

Profiles finishing

ABITAT

27  
Tcrom®

Vetri

Glasses

30  
Trasparente16  
Satinato

CARATTERISTICHE  
FEATURES



ALTEZZA PARETI DOCCIA 100/200  
SHOWER DOOR HEIGHT 100/200



SPESSORE LASTRA  
GLASS DEPTH



NON REVERSIBILE  
NON-REVERSIBLE

INFO TECNICHE  
TECHNICAL INFORMATION



PMR  
PMR



REGOLAZIONE FUORI SQUADRO  
OFF-SQUARE REGULATION



ESTENSIBILITÀ  
EXTENSIBILITY



CERNIERA +/- 90°  
+/- 90° HINGE



CERNIERA 180°  
180° HINGE



CHIUSURA MAGNETICA  
MAGNETIC CLOSURE



PROFILO DI COMPENSAZIONE  
COMPENSATOR PROFILE



PROFILO TENUTA ACQUA  
LOW SEAL WATER PROFILE



MANIGLIE ESTERNA/INTERNA  
EXTERNAL/INTERNAL HANDLES



TRATTAMENTO NEVERDROP®  
NEVERDROP® TREATMENT



MISURE SPECIALI  
SPECIAL SIZE



DECOGRAFIA  
DECOPRINTING

## in nicchia

VO-PBA

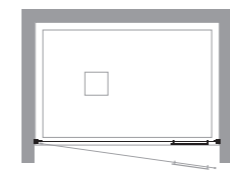

VO-PBA+VO-F

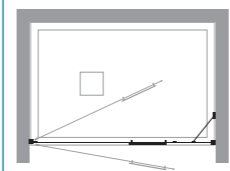

VO-PBA+VO-PBA

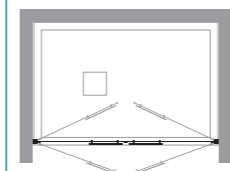

VO-PSO

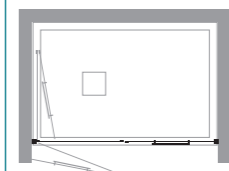

VO-PSO+VO-F

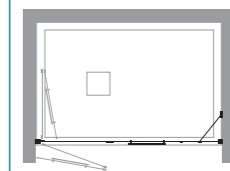

VO-PSO+VO-PSO

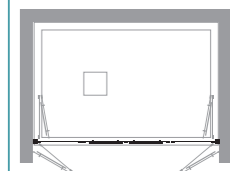

## in nicchia

VO-PFR+VO-PFR

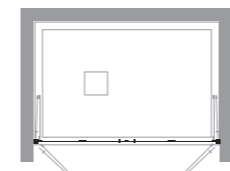

VO-PBS+VO-PBS

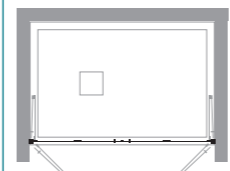

## niche

## ad angolo

VO-PBA+VO-PBA

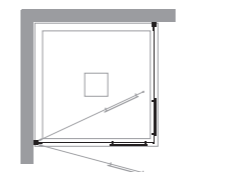

VO-PBA+VO-F

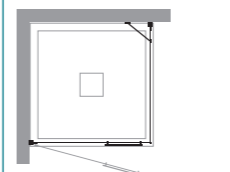

## corner

VO-PSO+VO-PSO

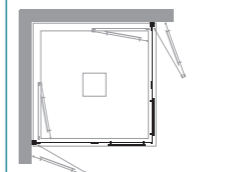

VO-PSO+VO-F

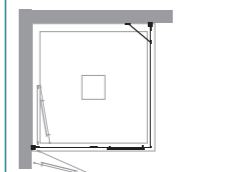

VO-PFR+VO-PFR

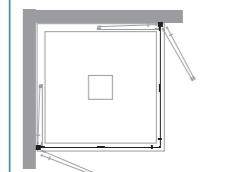

VO-PBS+VO-PBS

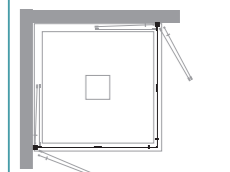

## ad angolo

VO-PFX+VO-PFX

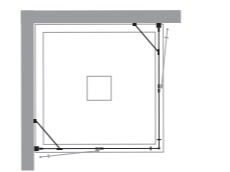

VO-PSO+VO+PBA

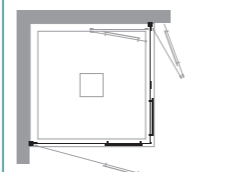

## corner

## profili

## profiles

per/for VO: PSO-PBA-PFX-PFR-PBS

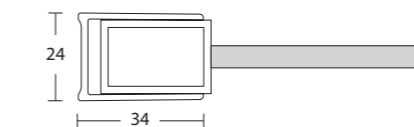

profilo a muro 1125 + schienale 1161

wall profile 1125 + vertical profile 1161

per/for VO-F

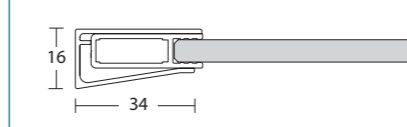

profilo a muro 966 + schienale 261

wall profile 966 + vertical profile 261

per/for VO: PSO-PBA

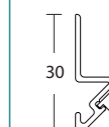

chiusura con magnete 1128

magnetic closing 1128

## importante

## important

ordini per pareti doccia speciali senza relativo disegno  
NON vengono prodotti

orders for special shower walls without related design are  
NOT produced

per installazioni particolari richiedere fattibilità. Alcune  
configurazioni necessitano di elementi aggiuntivi

contact TDA technical office for particular installation. More  
elements could be needed

installazione a 3 lati: VO-F + VO-PSO + parete fissa  
aggiuntiva Pluma PL-FA

three side installation: VO-F + VO-PSO+ additional fixed side  
panel Pluma PL-FA







SX  
LH



DX  
RH



H cm  
200



6 mm



REVO

incluso      included



PMR



2 cm



+/-90°



1,5 cm





NEVERDROP



L/H

disponibile      available





Misure standard

Standard sizes

| Codice SX<br>LH Code | Codice DX<br>RH Code | estensibilità<br>extension | Finiture profili<br>Profiles finishing | 30 | 16 |
|----------------------|----------------------|----------------------------|--|----|----|
| 12P040060            | 12P030060            | 57,5-59,5                  | Tcrom®                                 |    |    |
| 12P040065            | 12P030065            | 62,5-64,5                  | Tcrom®                                 |    |    |
| 12P040070            | 12P030070            | 67,5-69,5                  | Tcrom®                                 |    |    |
| 12P040075            | 12P030075            | 72,5-74,5                  | Tcrom®                                 |    |    |
| 12P040080            | 12P030080            | 77,5-79,5                  | Tcrom®                                 |    |    |
| 12P040085            | 12P030085            | 82,5-84,5                  | Tcrom®                                 |    |    |
| 12P040090            | 12P030090            | 87,5-89,5                  | Tcrom®                                 |    |    |
| 12P040095            | 12P030095            | 92,5-94,5                  | Tcrom®                                 |    |    |
| 12P040100            | 12P030100            | 97,5-99,5                  | Tcrom®                                 |    |    |
| 12P040105            | 12P030105            | 102,5-104,5                | Tcrom®                                 |    |    |
| 12P040110            | 12P030110            | 107,5-109,5                | Tcrom®                                 |    |    |
| 12P040115            | 12P030115            | 112,5-114,5                | Tcrom®                                 |    |    |
| 12P040120            | 12P030120            | 117,5-119,5                | Tcrom®                                 |    |    |

Misure speciali L / H

Special sizes L / H

| Codice SX<br>LH Code | Codice DX<br>RH Code | su misura<br>bespoke | Finiture profili<br>Profiles finishing | 30 | 16 |
|----------------------|----------------------|----------------------|--|----|----|
| 12P049001            | 12P039001            | 56 < L < 65          | Tcrom®                                 |    |    |
| 12P049001            | 12P039001            | 66 < L < 85          | Tcrom®                                 |    |    |
| 12P049001            | 12P039001            | 86 < L < 105         | Tcrom®                                 |    |    |
| 12P049001            | 12P039001            | 106 < L < 140        | Tcrom®                                 |    |    |

installazioni

installations





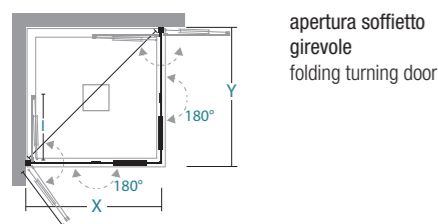

informazioni

informations



apertura soffietto  
girevole  
folding turning door

X/Y lunghezza parete doccia\ shower wall length  
I ingombro interno\ internal dimensions

| X/Y       | I    |  |  | X/Y         | I    |  |  |
|-----------|------|---|---|-------------|------|---|---|
| 57,5-59,5 | 29   | 1   | 25  | 92,5-94,5   | 46,5 | 1   | 37  |
| 62,5-64,5 | 31,5 | 1   | 27  | 97,5-99,5   | 49   | 1   | 39  |
| 67,5-69,5 | 34   | 1   | 29  | 102,5-104,5 | 51,5 | 1   | 40  |
| 72,5-74,5 | 36,5 | 1   | 30  | 107,5-109,5 | 54   | 1   | 42  |
| 77,5-79,5 | 39   | 1   | 32  | 112,5-114,5 | 56,5 | 1   | 43  |
| 82,5-84,5 | 41,5 | 1   | 34  | 117,5-119,5 | 59   | 2   | 44  |
| 87,5-89,5 | 44   | 1   | 36  |             |      |   |   |

attenzione

warning

Il prezzo della H speciale va trovato nella tabella Misure speciali L / H in base alla L della parete doccia

Special price for H is to be found in Special sizes L / H as per L needed size

Il prezzo è inteso per lato

Prices are to be intended for one side

Optical e Terra - decografia per: vetro Trasparente, Misure standard e speciali, max L 135 cm

Optical and Terra - decoprinting for: glass Trasparente, Standard and Special sizes, max L 135 cm

Specificare se installato a pavimento

Specify any floor installation

Nelle installazioni in nicchia o ad angolo VO-PSO+VO-PSO una delle due pareti doccia può essere sostituita con il modello VO-PBA  
Niche or corner VO-PSO+VO-PSO: one of the two sides can be substituted with Volo VO-PBA

Approfondimenti  
Insights



|   |     |
|---|-----|
| Indice<br>Index                           | 3   |
| Legenda simboli<br>Icons legend           | 11  |
| Profili - Vetri<br>Profiles - Glasses     | 21  |
| Ricambi<br>Spare parts                    | 406 |
| Profili speciali<br>Special profiles      | 434 |
| Schede rilievo misure<br>Measurement form | 444 |

Misure speciali  
Special size

|       |        |
|-------|--------|
| H max | 210 cm |
| L min | 56 cm  |
| L max | 140 cm |

supplementi

supplements

|                            |   |  |   |  |  |  |  |  |  |
|----------------------------|---|--|---|--|--|--|--|--|--|
| Decografia<br>Decoprinting | Sigillante SPARTAN®<br>Sealant SPARTAN® |  |   |  |  |  |  |  |  |
|                            | €                                       |  | € |  |  |  |  |  |  |

per codice  
for code 36B010010

|                |       |        |          |       |       |      |      |            |      |             |              |          |            |
|----------------|-------|--------|----------|-------|-------|------|------|------------|------|-------------|--------------|----------|------------|
| 05             | 11    | 12     | 16       | 24    | 25    | 26   | 27   | 28         | 29   | 30          | 31           | 32       | 34         |
| acrilico satin | flack | reflex | satinato | nigol | flute | wave | alon | fumè brown | fumè | trasparente | extrachiario | cincillà | stampato C |

abitat

27 Tcrom®







SX  
LH



DX  
RH



H cm  
200





6 mm





REV

incluso

included

disponibile



available



installazioni

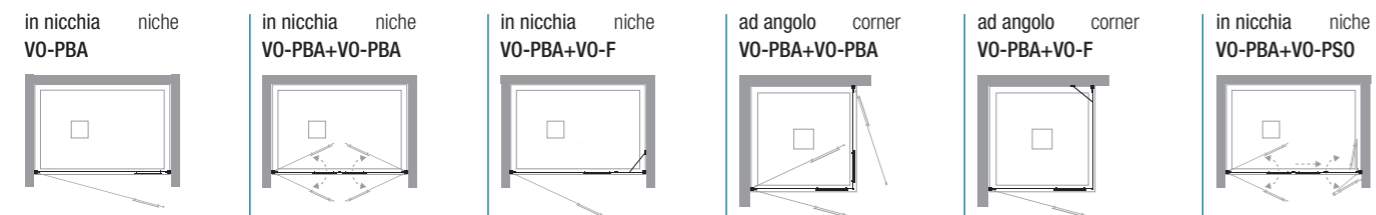

informazioni

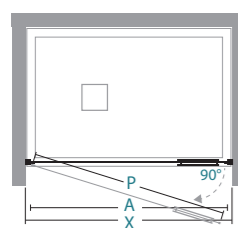

apertura battente  
swing door

informations

|           | X  | A  | P |  |  |  |  |   |    |
|-----------|----|----|---|--|--|--|--|---|----|
| 32,5-34,5 | 24 | 26 |   |  |  |  |  | 1 | 13 |
| 37,5-39,5 | 29 | 31 |   |  |  |  |  | 1 | 15 |
| 42,5-44,5 | 34 | 36 |   |  |  |  |  | 1 | 16 |
| 47,5-49,5 | 39 | 41 |   |  |  |  |  | 1 | 18 |
| 57,5-59,5 | 49 | 51 |   |  |  |  |  | 1 | 21 |
| 67,5-69,5 | 59 | 61 |   |  |  |  |  | 1 | 24 |
| 77,5-79,5 | 69 | 71 |   |  |  |  |  | 1 | 28 |
| 87,5-89,5 | 79 | 81 |   |  |  |  |  | 1 | 31 |

X lunghezza parete doccia \ shower wall length  
A spazio d'entrata \ entrance space  
P lunghezza porta \ door length

Misure standard

| Codice SX<br>LH Code | Codice DX<br>RH Code | estensibilità<br>extension | Finiture profili<br>Profiles finishing | 30 | 16 |
|----------------------|----------------------|----------------------------|--|----|----|
| 12P020035            | 12P010035            | 32,5-34,5                  | Tcrom®                                 |    |    |
| 12P020040            | 12P010040            | 37,5-39,5                  | Tcrom®                                 |    |    |
| 12P020045            | 12P010045            | 42,5-44,5                  | Tcrom®                                 |    |    |
| 12P020050            | 12P010050            | 47,5-49,5                  | Tcrom®                                 |    |    |
| 12P020060            | 12P010060            | 57,5-59,5                  | Tcrom®                                 |    |    |
| 12P020070            | 12P010070            | 67,5-69,5                  | Tcrom®                                 |    |    |
| 12P020080            | 12P010080            | 77,5-79,5                  | Tcrom®                                 |    |    |
| 12P020090            | 12P010090            | 87,5-89,5                  | Tcrom®                                 |    |    |

Standard sizes

Misure speciali L / H

| Codice SX<br>LH Code | Codice DX<br>RH Code | su misura<br>bespoke | Finiture profili<br>Profiles finishing | 30 | 16 |
|----------------------|----------------------|----------------------|--|----|----|
| 12P029001            | 12P019001            | 21 < L < 45          | Tcrom®                                 |    |    |
| 12P029001            | 12P019001            | 46 < L < 65          | Tcrom®                                 |    |    |
| 12P029001            | 12P019001            | 66 < L < 85          | Tcrom®                                 |    |    |
| 12P029001            | 12P019001            | 86 < L < 95          | Tcrom®                                 |    |    |

Special sizes L / H

attenzione

Il prezzo della H speciale va trovato nella tabella Misure speciali L / H in base alla L della parete doccia

Special price for H is to be found in Special sizes L / H as per L needed size

warning

Optical e Terra - decografia per: vetro Trasparente, Misure standard e speciali, max L 135 cm

Optical and Terra - decoprinting for: glass Trasparente, Standard and Special sizes, max L 135 cm

Specificare se installato a pavimento

Specify any floor installation

Nelle installazioni in nicchia o ad angolo VO-PBA+VO-PBA una delle due pareti doccia può essere sostituita con il modello VO-PSO  
Niche or corner VO-PBA+VO-PBA: one of the two sides can be substituted with Volo VO-PSO

Per misure di X < 34 cm la maniglia viene montata verticale  
For X < 34 cm the angle is vertical mounted

Approfondimenti  
Insights



|   |     |
|---|-----|
| Indice<br>Index                           | 3   |
| Legenda simboli<br>Icons legend           | 11  |
| Profili - Vetri<br>Profiles - Glasses     | 21  |
| Ricambi<br>Spare parts                    | 406 |
| Profili speciali<br>Special profiles      | 434 |
| Schede rilievo misure<br>Measurement form | 444 |

Misure speciali  
Special size

|   |     |        |
|---|-----|--------|
| H | max | 210 cm |
| L | min | 21 cm  |
| L | max | 95 cm  |

supplementi

Decografia  
Decoprinting

Sigillante SPARTAN®  
Sealant SPARTAN®

per codice  
for code

36B010010

|                |       |        |          |       |       |      |      |            |      |             |             |          |            |
|----------------|-------|--------|----------|-------|-------|------|------|------------|------|-------------|-------------|----------|------------|
| 05             | 11    | 12     | 16       | 24    | 25    | 26   | 27   | 28         | 29   | 30          | 31          | 32       | 34         |
| acrilico satin | flack | reflex | satinato | nigol | flute | wave | alon | fumè brown | fumè | trasparente | extrachiaro | cincillà | stampato C |

abitat

27 Tcrom®

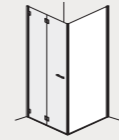

incluso

included



disponibile

available



### installazioni

in nicchia niche  
VO-F+VO-PSO

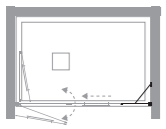

### installations

ad angolo corner  
VO-F+VO-PSO

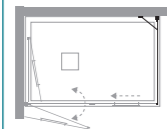

ad angolo corner  
VO-F+VO-PSO+PL-FA

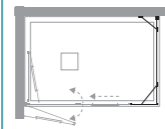

a tre lati three sides  
VO-F+VO-PSO+PL-FA

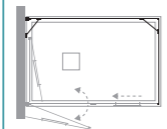

### informazioni

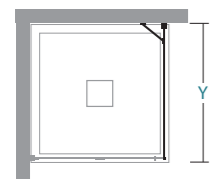

### informations

| Y         |  |  |  |  |  |  |  |   |    |
|-----------|--|--|--|--|--|--|--|---|----|
| 42,5-44,5 |  |  |  |  |  |  |  | 1 | 16 |
| 47,5-49,5 |  |  |  |  |  |  |  | 1 | 17 |
| 57,5-59,5 |  |  |  |  |  |  |  | 1 | 21 |
| 67,5-69,5 |  |  |  |  |  |  |  | 1 | 24 |
| 77,5-79,5 |  |  |  |  |  |  |  | 1 | 27 |
| 87,5-89,5 |  |  |  |  |  |  |  | 1 | 31 |

Y lunghezza parete doccia\ shower wall length

### Misure standard

### Standard sizes

| Codice<br>Code | estensibilità<br>extension | Finiture profili<br>Profiles finishing | 30 | 16 |
|----------------|----------------------------|--|----|----|
| 12F020045      | 42,5-44,5                  | Tcrom®                                 |    |    |
| 12F020050      | 47,5-49,5                  | Tcrom®                                 |    |    |
| 12F020060      | 57,5-59,5                  | Tcrom®                                 |    |    |
| 12F020070      | 67,5-69,5                  | Tcrom®                                 |    |    |
| 12F020080      | 77,5-79,5                  | Tcrom®                                 |    |    |
| 12F020090      | 87,5-89,5                  | Tcrom®                                 |    |    |

### Misure speciali L / H

### Special sizes L / H

| Codice<br>Code | su misura<br>bespoke | Finiture profili<br>Profiles finishing | 30 | 16 |
|----------------|----------------------|--|----|----|
| 12F029001      | 12 < L < 45          | Tcrom®                                 |    |    |
| 12F029001      | 46 < L < 75          | Tcrom®                                 |    |    |
| 12F029001      | 76 < L < 105         | Tcrom®                                 |    |    |
| 12F029001      | 106 < L < 135        | Tcrom®                                 |    |    |
| 12F029001      | 136 < L < 155        | Tcrom®                                 |    |    |
| 12F029001      | 156 < L < 180        | Tcrom®                                 |    |    |

### attenzione

Il prezzo della H speciale va trovato nella tabella Misure speciali L / H in base alla L della parete doccia

Special price for H is to be found in Special sizes L / H as per L needed size

### warning

Optical e Terra - decografia per: vetro Trasparente, Misure standard e speciali, max L 135 cm

Optical and Terra - decoprinting for: glass Trasparente, Standard and Special sizes, max L 135 cm

Incluso: supporto di rinforzo regolabile e snodato

Included: adjustable, articulated supporting bar

Installazione a 3 lati: VO-F + VO-PSO + parete fissa aggiuntiva Pluma PL-FA

Three sides installation: VO-F + VO-PSO + additional fixed side panel Pluma PL-FA

### Misure speciali Special size

|   |     |        |
|---|-----|--------|
| H | max | 210 cm |
| L | min | 12 cm  |
| L | max | 180 cm |

### supplementi

Decografia  
Decoprinting

Sigillante SPARTAN®  
Sealant SPARTAN®

€

### supplements

€

per codice  
for code

36B010010

|                |       |        |          |       |       |      |      |            |      |             |              |          |            |
|----------------|-------|--------|----------|-------|-------|------|------|------------|------|-------------|--------------|----------|------------|
| 05             | 11    | 12     | 16       | 24    | 25    | 26   | 27   | 28         | 29   | 30          | 31           | 32       | 34         |
| acrilico satin | flack | reflex | satinato | nigol | flute | wave | alon | fumè brown | fumè | trasparente | extrachiario | cincillà | stampato C |

abitat

27 Tcrom®

### Approfondimenti Insights



|   |     |
|---|-----|
| Indice<br>Index                           | 3   |
| Legenda simboli<br>Icons legend           | 11  |
| Profili - Vetri<br>Profiles - Glasses     | 21  |
| Ricambi<br>Spare parts                    | 406 |
| Profili speciali<br>Special profiles      | 434 |
| Schede rilievo misure<br>Measurement form | 444 |





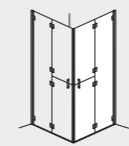

SX  
LH





DX  
RH

incluso

included

disponibile



available



installazioni

in nicchia niche  
VO-PFR+VO-PFR

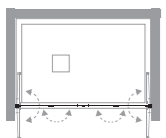

installations

ad angolo corner  
VO-PFR+VO-PFR

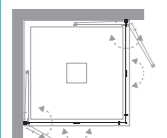

informazioni

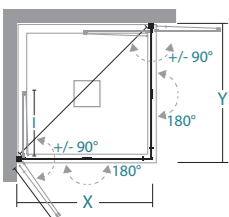

informations

apertura soffietto  
girevole  
folding turning door

X/Y lunghezza parete doccia\ shower wall length  
I ingombro interno\ internal dimensions

| X/Y       | I    |   |    | X/Y         | I    |   |    |
|-----------|------|---|----|-------------|------|---|----|
| 57,5-59,5 | 29   | 1 | 24 | 92,5-94,5   | 46,5 | 1 | 35 |
| 62,5-64,5 | 31,5 | 1 | 25 | 97,5-99,5   | 49   | 1 | 37 |
| 67,5-69,5 | 34   | 1 | 27 | 102,5-104,5 | 51,5 | 1 | 39 |
| 72,5-74,5 | 36,5 | 1 | 29 | 107,5-109,5 | 54   | 1 | 40 |
| 77,5-79,5 | 39   | 1 | 30 | 112,5-114,5 | 56,5 | 1 | 42 |
| 82,5-84,5 | 41,5 | 1 | 32 | 117,5-119,5 | 59   | 2 | 43 |
| 87,5-89,5 | 44   | 1 | 34 |             |      |   |    |

Misure standard

Standard sizes

| Codice SX<br>LH Code | Codice DX<br>RH Code | estensibilità<br>extension | Finiture profili<br>Profiles finishing | 30 | 16 |
|----------------------|----------------------|----------------------------|--|----|----|
| 12P130060            | 12P120060            | 57,5-59,5                  | Tcrom®                                 |    |    |
| 12P130065            | 12P120065            | 62,5-64,5                  | Tcrom®                                 |    |    |
| 12P130070            | 12P120070            | 67,5-69,5                  | Tcrom®                                 |    |    |
| 12P130075            | 12P120075            | 72,5-74,5                  | Tcrom®                                 |    |    |
| 12P130080            | 12P120080            | 77,5-79,5                  | Tcrom®                                 |    |    |
| 12P130085            | 12P120085            | 82,5-84,5                  | Tcrom®                                 |    |    |
| 12P130090            | 12P120090            | 87,5-89,5                  | Tcrom®                                 |    |    |
| 12P130095            | 12P120095            | 92,5-94,5                  | Tcrom®                                 |    |    |
| 12P130100            | 12P120100            | 97,5-99,5                  | Tcrom®                                 |    |    |
| 12P130105            | 12P120105            | 102,5-104,5                | Tcrom®                                 |    |    |
| 12P130110            | 12P120110            | 107,5-109,5                | Tcrom®                                 |    |    |
| 12P130115            | 12P120115            | 112,5-114,5                | Tcrom®                                 |    |    |
| 12P130120            | 12P120120            | 117,5-119,5                | Tcrom®                                 |    |    |

attenzione

Optical e Terra - decografia  
per: vetro Trasparente,  
Misure standard e speciali,  
max L 135 cm

Optical and Terra - decoprinting  
for: glass Trasparente,  
Standard and Special sizes,  
max L 135 cm

warning

Specificare se installato a  
pavimento

Specify any floor installation

supplementi

Decografia  
Decoprinting

Sigillante SPARTAN®  
Sealant SPARTAN®

€ 36B010010

supplements

€

per codice  
for code

- 05 acrilico satin
- 11 flack
- 12 reflex
- 16 satinato
- 24 nigol
- 25 flute
- 26 wave
- 27 aion
- 28 fumè brown
- 29 fumè
- 30 trasparente
- 31 extrachiaro
- 32 cincillà
- 34 stampato C

abitat

27 Tcrom®

Approfondimenti  
Insights



|   |     |
|---|-----|
| Indice<br>Index                           | 3   |
| Legenda simboli<br>Icons legend           | 11  |
| Profili - Vetri<br>Profiles - Glasses     | 21  |
| Ricambi<br>Spare parts                    | 406 |
| Profili speciali<br>Special profiles      | 434 |
| Schede rilievo misure<br>Measurement form | 444 |



SX  
LH

DX  
RH

H cm  
100

6 mm

REVO

incluso

included

disponibile

available

installazioni

in nicchia niche  
VO-PBS+VO-PBS

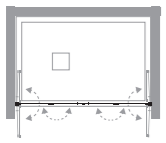

installations

ad angolo corner  
VO-PBS+VO-PBS

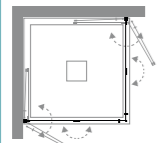

informazioni

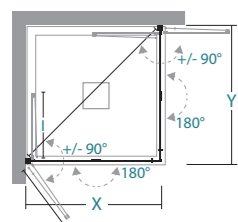

informations

apertura soffietto  
girevole  
folding turning door

X/Y lunghezza parete doccia\ shower wall length  
I ingombro interno\ internal dimensions

| X/Y       | I    |   |    | X/Y         | I    |   |    |
|-----------|------|---|----|-------------|------|---|----|
| 57,5-59,5 | 29   | 1 | 11 | 92,5-94,5   | 46,5 | 1 | 18 |
| 62,5-64,5 | 31,5 | 1 | 12 | 97,5-99,5   | 49   | 1 | 19 |
| 67,5-69,5 | 34   | 1 | 13 | 102,5-104,5 | 51,5 | 1 | 20 |
| 72,5-74,5 | 36,5 | 1 | 14 | 107,5-109,5 | 54   | 1 | 21 |
| 77,5-79,5 | 39   | 1 | 15 | 112,5-114,5 | 56,5 | 1 | 22 |
| 82,5-84,5 | 41,5 | 1 | 16 | 117,5-119,5 | 59   | 1 | 23 |
| 87,5-89,5 | 44   | 1 | 17 |             |      |   |    |

Misure standard

Standard sizes

| Codice SX<br>LH Code | Codice DX<br>RH Code | estensibilità<br>extension | Finiture profili<br>Profiles finishing | 30 | 16 |
|----------------------|----------------------|----------------------------|--|----|----|
| 12P110060            | 12P100060            | 57,5-59,5                  | Tcrom®                                 |    |    |
| 12P110065            | 12P100065            | 62,5-64,5                  | Tcrom®                                 |    |    |
| 12P110070            | 12P100070            | 67,5-69,5                  | Tcrom®                                 |    |    |
| 12P110075            | 12P100075            | 72,5-74,5                  | Tcrom®                                 |    |    |
| 12P110080            | 12P100080            | 77,5-79,5                  | Tcrom®                                 |    |    |
| 12P110085            | 12P100085            | 82,5-84,5                  | Tcrom®                                 |    |    |
| 12P110090            | 12P100090            | 87,5-89,5                  | Tcrom®                                 |    |    |
| 12P110095            | 12P100095            | 92,5-94,5                  | Tcrom®                                 |    |    |
| 12P110100            | 12P100100            | 97,5-99,5                  | Tcrom®                                 |    |    |
| 12P110105            | 12P100105            | 102,5-104,5                | Tcrom®                                 |    |    |
| 12P110110            | 12P100110            | 107,5-109,5                | Tcrom®                                 |    |    |
| 12P110115            | 12P100115            | 112,5-114,5                | Tcrom®                                 |    |    |
| 12P110120            | 12P100120            | 117,5-119,5                | Tcrom®                                 |    |    |

attenzione

Optical e Terra - decografia  
per: vetro Trasparente,  
Misure standard e speciali,  
max L 135 cm

Optical and Terra - decoprinting  
for: glass Trasparente,  
Standard and Special sizes,  
max L 135 cm

warning

Specificare se installato a  
pavimento

Specify any floor installation

supplementi

Decografia  
Decoprinting

supplements

Sigillante SPARTAN®  
Sealant SPARTAN®

per codice  
for code

|                |       |        |          |       |       |      |      |            |      |             |             |          |            |
|----------------|-------|--------|----------|-------|-------|------|------|------------|------|-------------|-------------|----------|------------|
| 05             | 11    | 12     | 16       | 24    | 25    | 26   | 27   | 28         | 29   | 30          | 31          | 32       | 34         |
| acrilico satin | flack | reflex | satinato | nigol | flute | wave | alou | fumè brown | fumè | trasparente | extrachiaro | cincillà | stampato C |

abitat

27 Tcrom®

Approfondimenti  
Insights



|   |     |
|---|-----|
| Indice<br>Index                           | 3   |
| Legenda simboli<br>Icons legend           | 11  |
| Profili - Vetri<br>Profiles - Glasses     | 21  |
| Ricambi<br>Spare parts                    | 406 |
| Profili speciali<br>Special profiles      | 434 |
| Schede rilievo misure<br>Measurement form | 444 |



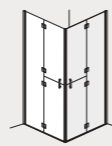

SX  
LH

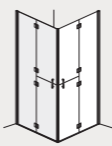

DX  
RH

incluso      included

disponibile      available

installazioni

in nicchia niche  
VO-PFX+VO-PFX

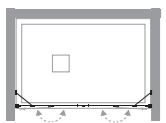

installations

ad angolo corner  
VO-PFX+VO-PFX

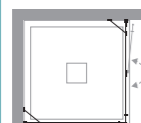

informazioni

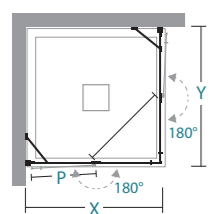

informations

apertura battente  
swing door

X/Y lunghezza parete doccia\ shower wall length  
P lunghezza porta\ door length

| X           | P  |  |  |  |  |  |  |   |    |
|-------------|----|--|--|--|--|--|--|---|----|
| 77,5-79,5   | 39 |  |  |  |  |  |  | 1 | 27 |
| 82,5-84,5   | 42 |  |  |  |  |  |  | 1 | 29 |
| 87,5-89,5   | 44 |  |  |  |  |  |  | 1 | 30 |
| 92,5-94,5   | 47 |  |  |  |  |  |  | 1 | 32 |
| 97,5-99,5   | 49 |  |  |  |  |  |  | 1 | 34 |
| 102,5-104,5 | 52 |  |  |  |  |  |  | 1 | 35 |
| 107,5-109,5 | 54 |  |  |  |  |  |  | 1 | 37 |
| 112,5-114,5 | 57 |  |  |  |  |  |  | 1 | 39 |
| 117,5-119,5 | 59 |  |  |  |  |  |  | 1 | 40 |

Misure standard      Standard sizes

| Codice SX<br>LH Code | Codice DX<br>RH Code | estensibilità<br>extension | Finiture profili<br>Profiles finishing | 30 | 16 |
|----------------------|----------------------|----------------------------|--|----|----|
| 12P150080            | 12P140080            | 77,5-79,5                  | Tcrom®                                 |    |    |
| 12P150085            | 12P140085            | 82,5-84,5                  | Tcrom®                                 |    |    |
| 12P150090            | 12P140090            | 87,5-89,5                  | Tcrom®                                 |    |    |
| 12P150095            | 12P140095            | 92,5-94,5                  | Tcrom®                                 |    |    |
| 12P150100            | 12P140100            | 97,5-99,5                  | Tcrom®                                 |    |    |
| 12P150105            | 12P140105            | 102,5-104,5                | Tcrom®                                 |    |    |
| 12P150110            | 12P140110            | 107,5-109,5                | Tcrom®                                 |    |    |
| 12P150115            | 12P140115            | 112,5-114,5                | Tcrom®                                 |    |    |
| 12P150120            | 12P140120            | 117,5-119,5                | Tcrom®                                 |    |    |

attenzione

Optical e Terra - decografia per: vetro Trasparente, Misure standard e speciali, max L 135 cm

Optical and Terra - decoprinting for: glass Trasparente, Standard and Special sizes, max L 135 cm

warning

Specificare se installato a pavimento

Specify any floor installation

Incluso: supporto di rinforzo regolabile e snodato

Included: adjustable, articulated supporting bar

supplementi

Decografia  
Decoprinting

per codice  
for code

05 acrilico satin  
11 flack

Sigillante SPARTAN®  
Sealant SPARTAN®

€      €

36B010010

abitat

27 Tcrom®

supplements

12 reflex      16 satinato      24 nigol      25 flute      26 wave      27 aion      28 fumè brown      29 fumè      30 trasparente      31 extrachiaro      32 cincià      34 stampato C

Approfondimenti  
Insights



|   |     |
|---|-----|
| Indice<br>Index                           | 3   |
| Legenda simboli<br>Icons legend           | 11  |
| Profili - Vetri<br>Profiles - Glasses     | 21  |
| Ricambi<br>Spare parts                    | 406 |
| Profili speciali<br>Special profiles      | 434 |
| Schede rilievo misure<br>Measurement form | 444 |

## CON PROFILO VERTICALE WITH VERTICAL PROFILE

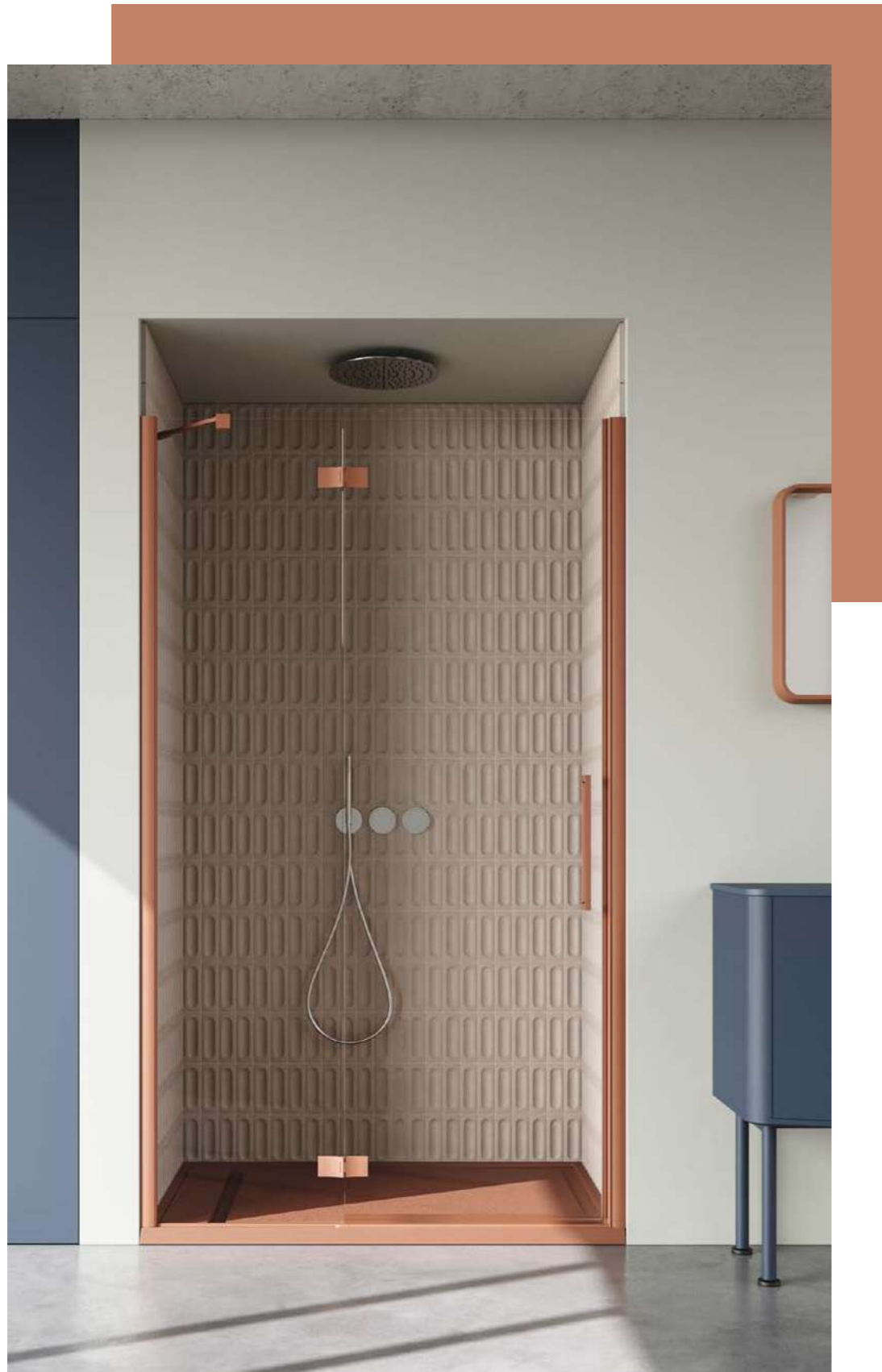

Porta battente installazione in nicchia  
profilo Havana / vetro Trasparente  
Piatto doccia ADELMO

Hinged door niche installation  
Havana profile / Transparent glass  
Shower tray ADELMO

## FONT

Ante a battente e un elevato potenziale di adattabilità grazie all'estensione fino a 6 cm dei profili laterali. Lo stile essenziale e pratico di questa linea è caratterizzato dalla porta a battente e dai profili sottili e personalizzabili nei colori della palette TDA. Il design accurato e l'attenzione produttiva offrono il miglior risultato in termini di regolazione

Swinging doors and a high adaptability - the lateral profiles can be extended up to 6 cm. This line has an essential and practical style, characterized by the swinging hinged door and the slim profiles, which can be customized in the colours of the palette by TDA. The accurate design and the detailed production process offer the best result in terms of regulation and adjustments



01



02

03  
04

01 cerniera in metallo con doppia regolazione su porta e fisso | 02 sistema di estensione tramite profilo compensatore e schienale | 03 maniglia esterna/pomoli interni per FO-ASC | 04 doppia maniglia esterna/interna interasse 32cm |

01 metal hinge, adjustments on swinging and fixed doors possible | 02 adjustment by wall profile and vertical profile | 03 external handle/internal knob for FO-ASC | 04 double handle external/internal, interaxe 32cm |



### CARATTERISTICHE FEATURES

- H cm 200** ALTEZZA PARETI DOCCIA  
SHOWER DOOR HEIGHT
- 6 mm** SPESSORE LASTRA  
GLASS DEPTH
- REV** NON REVERSIBILE  
NON-REVERSIBLE

### INFO TECNICHE TECHNICAL INFORMATION

- L** REGOLAZIONE FUORI SQUADRO  
OFF-SQUARE REGULATION
- EST cm** ESTENSIBILITÀ 3/6  
EXTENSIBILITY 3/6
- U** CHIUSURA MAGNETICA  
MAGNETIC CLOSURE
- W** PROFILO TENUTA ACQUA  
LOW SEAL WATER PROFILE
- H** MANIGLIE ESTERNA/INTERNA  
EXTERNAL/INTERNAL HANDLES
- P** MANIGLIA ESTERNA/POMOLO INTERNO  
EXTERNAL HANDLE/INTERNAL POMMEL
- L/H** MISURE SPECIALI  
SPECIAL SIZES
- NEVERDROP** TRATTAMENTO NEVERDROP®  
NEVERDROP® TREATMENT

### Finiture profili

#### ORIGIN

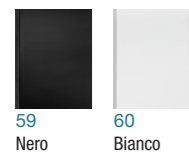

59 Nero  
60 Bianco

### Profiles finishing

#### ABITAT

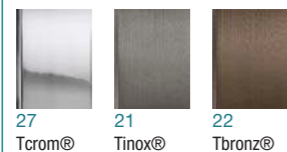

27 T Crom®  
21 Tinox®  
22 T bronz®

#### VOGUE

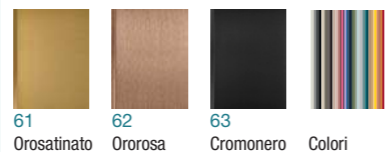

61 Orosatinato  
62 Ororosa  
63 Cromonero  
Colori



64 Franciacorta  
65 Rame  
66 Brownie

### Vetri

### Glasses

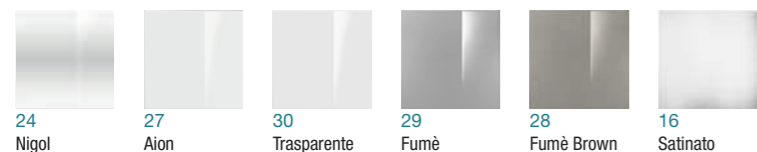

24 Nigol  
27 Aion  
30 Trasparente  
29 Fumè  
28 Fumè Brown  
16 Satinato

### in nicchia

FO-PBA

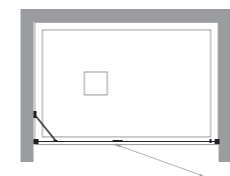

### niche

### ad angolo

FO-ABA+FO-ABA

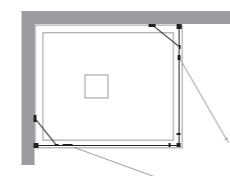

FO-ABA+FO-F

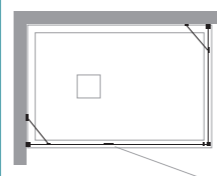

### corner

### profili

### profiles

per/for FO: PBA-ABA-F

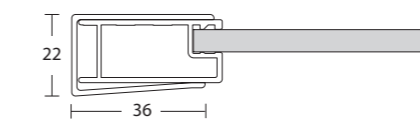

profilo a muro 1327 + schienale 1123  
wall profile 1327 + vertical profile 1123

per/for FO-PBA

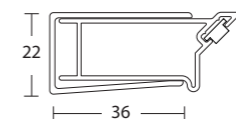

profilo a muro 1327 + chiusura con magnete 888  
wall profile 1327 + magnetic closing 888

per/for

### importante

### important

ordini per pareti doccia speciali senza relativo disegno  
NON vengono prodotti

orders for special shower walls without related design are  
NOT produced



SX  
LH

DX  
RH

H cm  
200

6 mm

REV

incluso

included

NEVERDROP®

L/H

disponibile

3 cm

available

installazioni

in nicchia niche  
FO-PBA

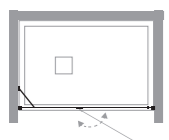

installations

informazioni

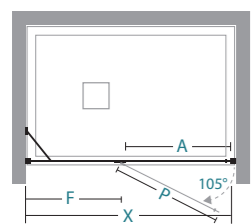

apertura battente  
swing door

informations

|         | X  | A  | P    | F |  |  |  |  |   |    |
|---------|----|----|------|---|--|--|--|--|---|----|
| 76-82   | 53 | 56 | 15,3 |   |  |  |  |  | 1 | 30 |
| 86-92   | 62 | 66 | 15,3 |   |  |  |  |  | 1 | 33 |
| 92-98   | 62 | 66 | 21,3 |   |  |  |  |  | 1 | 34 |
| 96-102  | 62 | 66 | 25,3 |   |  |  |  |  | 1 | 35 |
| 106-112 | 62 | 66 | 35,3 |   |  |  |  |  | 1 | 40 |
| 116-122 | 62 | 66 | 45,3 |   |  |  |  |  | 1 | 43 |

- X lunghezza parete doccia\ shower wall length
- A spazio d'entrata\ entrance space
- P lunghezza porta\ door length
- F lunghezza lato fisso\ fixed side length

Misure standard

Standard sizes

| Codice SX<br>LH Code | Codice DX<br>RH Code | estensibilità<br>extension | Finiture profili<br>Profiles finishing | 30 | 16 | 29 | 28 |
|----------------------|----------------------|----------------------------|--|----|----|----|----|
| 10P030080            | 10P020080            | 76-82                      | origin<br>abiat<br>vogue               |    |    |    |    |
| 10P030090            | 10P020090            | 86-92                      | origin<br>abiat<br>vogue               |    |    |    |    |
| 10P030095            | 10P020095            | 92-98                      | origin<br>abiat<br>vogue               |    |    |    |    |
| 10P030100            | 10P020100            | 96-102                     | origin<br>abiat<br>vogue               |    |    |    |    |
| 10P030110            | 10P020110            | 106-112                    | origin<br>abiat<br>vogue               |    |    |    |    |
| 10P030120            | 10P020120            | 116-122                    | origin<br>abiat<br>vogue               |    |    |    |    |

Misure speciali L / H

Special sizes L / H

| Codice SX<br>LH Code | Codice DX<br>RH Code | su misura<br>bespoke | Finiture profili<br>Profiles finishing | 30 | 16 | 29 | 28 | 24 | 27 |
|----------------------|----------------------|----------------------|--|----|----|----|----|----|----|
| 10P039001            | 10P029001            | 61 < L < 90          | origin<br>abiat<br>vogue               |    |    |    |    |    |    |
| 10P039001            | 10P029001            | 91 < L < 120         | origin<br>abiat<br>vogue               |    |    |    |    |    |    |
| 10P039001            | 10P029001            | 121 < L < 140        | origin<br>abiat<br>vogue               |    |    |    |    |    |    |

attenzione

Il prezzo della H speciale va trovato nella tabella Misure speciali L / H in base alla L della parete doccia

Special price for H is to be found in Special sizes L / H as per L needed size

warning

Incluso: supporto di rinforzo regolabile e snodato

Included: adjustable, articulated supporting bar

Misure speciali  
Special size

|   |     |        |
|---|-----|--------|
| H | max | 210 cm |
| L | min | 61 cm  |
| L | max | 140 cm |

supplementi

Profilo di compensazione 3 cm  
Extension profile 3 cm

€

35A010200

supplements

Sigillante SPARTAN®  
Sealant SPARTAN®

€

36B010010

Approfondimenti  
Insights



|   |     |
|---|-----|
| Indice<br>Index                           | 3   |
| Legenda simboli<br>Icons legend           | 11  |
| Profili - Vetri<br>Profiles - Glasses     | 21  |
| Ricambi<br>Spare parts                    | 406 |
| Profili speciali<br>Special profiles      | 434 |
| Schede rilievo misure<br>Measurement form | 444 |

| 05                  | 11                                 | 12     | 16       | 24   | 25    | 26   | 27   | 28         | 29   | 30          | 31           | 32       | 34         |
|---------------------|------------------------------------|--------|----------|--|-------|------|------|------------|------|-------------|--------------|----------|------------|
| acrilico satin      | flack                              | reflex | satinato | nigol  | flute | wave | alon | fumè brown | fumè | trasparente | extrachiario | cincillà | stampato C |
| origin              | abiat                              |        |          | vogue  |       |      |      |            |      |             |              |          |            |
| 59 Nero / 60 Bianco | 27 Tcrom® / 21 Tinox® / 22 Tbronz® |        |          | 61 Orosatinato / 62 Ororosa / 63 Cromonero / 64 Franciacorta / 65 Rame / 66 Brownie / Colori |       |      |      |            |      |             |              |          |            |

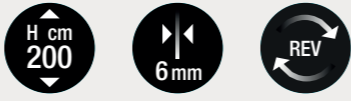

incluso included



disponibile available



installazioni

ad angolo corner  
FO-F+FO-ABA

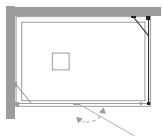

informazioni

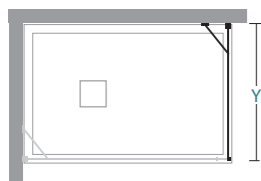

Y lunghezza parete doccia\ shower wall length

installations

informations

| Y       |  |  |  |  |  |  |  |  |  |  |   |    |
|---------|--|--|--|--|--|--|--|--|--|--|---|----|
| 67-70   |  |  |  |  |  |  |  |  |  |  | 1 | 25 |
| 72-75   |  |  |  |  |  |  |  |  |  |  | 1 | 26 |
| 77-80   |  |  |  |  |  |  |  |  |  |  | 1 | 29 |
| 87-90   |  |  |  |  |  |  |  |  |  |  | 1 | 31 |
| 97-100  |  |  |  |  |  |  |  |  |  |  | 1 | 35 |
| 117-120 |  |  |  |  |  |  |  |  |  |  | 1 | 40 |

Misure standard Standard sizes

| Codice Code | estensibilità extension | Finiture profili Profiles finishing | 30 | 16 | 29 | 28 |
|-------------|-------------------------|-------------------------------------|----|----|----|----|
| 10F020070   | 67-70                   | origin                              |    |    |    |    |
|             |                         | abitat                              | ■  |    |    |    |
|             |                         | vogue                               |    |    |    |    |
| 10F020075   | 72-75                   | origin                              |    |    |    |    |
|             |                         | abitat                              |    |    |    |    |
|             |                         | vogue                               |    |    |    |    |
| 10F020080   | 77-80                   | origin                              |    |    |    |    |
|             |                         | abitat                              | ■  |    |    |    |
|             |                         | vogue                               |    |    |    |    |
| 10F020090   | 87-90                   | origin                              |    |    |    |    |
|             |                         | abitat                              | ■  |    |    |    |
|             |                         | vogue                               |    |    |    |    |
| 10F020100   | 97-100                  | origin                              |    |    |    |    |
|             |                         | abitat                              |    |    |    |    |
|             |                         | vogue                               |    |    |    |    |
| 10F020120   | 117-120                 | origin                              |    |    |    |    |
|             |                         | abitat                              |    |    |    |    |
|             |                         | vogue                               |    |    |    |    |

Misure speciali L / H Special sizes L / H

| Codice Code | su misura bespoke | Finiture profili Profiles finishing | 30 | 16 | 29 | 28 | 24 | 27 |
|-------------|-------------------|-------------------------------------|----|----|----|----|----|----|
| 10F029001   | 12 < L < 60       | origin                              |    |    |    |    |    |    |
|             |                   | abitat                              |    |    |    |    |    |    |
|             |                   | vogue                               |    |    |    |    |    |    |
| 10F029001   | 61 < L < 90       | origin                              |    |    |    |    |    |    |
|             |                   | abitat                              |    |    |    |    |    |    |
|             |                   | vogue                               |    |    |    |    |    |    |
| 10F029001   | 91 < L < 120      | origin                              |    |    |    |    |    |    |
|             |                   | abitat                              |    |    |    |    |    |    |
|             |                   | vogue                               |    |    |    |    |    |    |
| 10F029001   | 121 < L < 140     | origin                              |    |    |    |    |    |    |
|             |                   | abitat                              |    |    |    |    |    |    |
|             |                   | vogue                               |    |    |    |    |    |    |

attenzione

Il prezzo della H speciale va trovato nella tabella Misure speciali L / H in base alla L della parete doccia

Special price for H is to be found in Special sizes L / H as per L needed size

warning

Incluso: supporto di rinforzo regolabile e snodato

Included: adjustable, articulated supporting bar

Misure speciali Special size

|       |        |
|-------|--------|
| H max | 210 cm |
| L min | 12 cm  |
| L max | 140 cm |

Disponibilità Availability

■ STOCK Tcrom®

supplementi

Profilo di compensazione 3 cm Extension profile 3 cm

€

05

acrilico satin flack

11

reflex

12

satinato

16

nigol

24

flute

25

wave

26

alon

27

fumè brown

28

fumè

29

trasparente

30

extrachiario

31

cincillà

32

stampato C

34

stampato C

origin

59 Nero / 60 Bianco

abitat

27 Tcrom® / 21 Tinox® / 22 Tbronz®

vogue

61 Orosatinato / 62 Ororosa / 63 Cromonero / 64 Franciacorta / 65 Rame / 66 Brownie / Colori

Approfondimenti Insights



|  |     |
|--|-----|
| Indice Index                           | 3   |
| Legenda simboli Icons legend           | 11  |
| Profili - Vetri Profiles - Glasses     | 21  |
| Ricambi Spare parts                    | 406 |
| Profili speciali Special profiles      | 434 |
| Schede rilievo misure Measurement form | 444 |



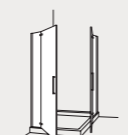

SX  
LH

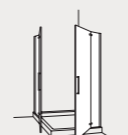

DX  
RH

incluso      included

disponibile      available

| Misure standard      |                      |                            | Standard sizes                         |    |    |    |    |
|----------------------|----------------------|----------------------------|--|----|----|----|----|
| Codice SX<br>LH Code | Codice DX<br>RH Code | estensibilità<br>extension | Finiture profili<br>Profiles finishing | 30 | 16 | 29 | 28 |
| 10A030070            | 10A020070            | 67-70                      | origin<br>abitat<br>vogue              |    |    |    |    |
| 10A030080            | 10A020080            | 77-80                      | origin<br>abitat<br>vogue              |    |    |    |    |
| 10A030090            | 10A020090            | 87-90                      | origin<br>abitat<br>vogue              |    |    |    |    |
| 10A030095            | 10A020095            | 92-95                      | origin<br>abitat<br>vogue              |    |    |    |    |
| 10A030100            | 10A020100            | 97-100                     | origin<br>abitat<br>vogue              |    |    |    |    |
| 10A030110            | 10A020110            | 107-110                    | origin<br>abitat<br>vogue              |    |    |    |    |
| 10A030120            | 10A020120            | 117-120                    | origin<br>abitat<br>vogue              |    |    |    |    |
| 10A030140            | 10A020140            | 137-140                    | origin<br>abitat<br>vogue              |    |    |    |    |

| Misure speciali L / H |                      |                      | Special sizes L / H                    |    |    |    |    |    |    |
|-----------------------|----------------------|----------------------|--|----|----|----|----|----|----|
| Codice SX<br>LH Code  | Codice DX<br>RH Code | su misura<br>bespoke | Finiture profili<br>Profiles finishing | 30 | 16 | 29 | 28 | 24 | 27 |
| 10A039001             | 10A029001            | 61 < L < 90          | origin<br>abitat<br>vogue              |    |    |    |    |    |    |
| 10A039001             | 10A029001            | 91 < L < 120         | origin<br>abitat<br>vogue              |    |    |    |    |    |    |
| 10A039001             | 10A029001            | 121 < L < 140        | origin<br>abitat<br>vogue              |    |    |    |    |    |    |

installazioni      installations

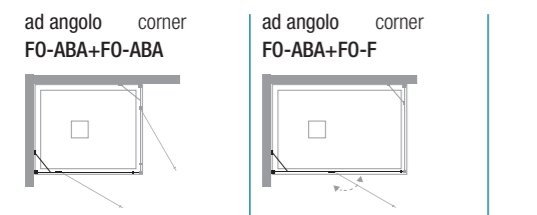

informazioni      informations

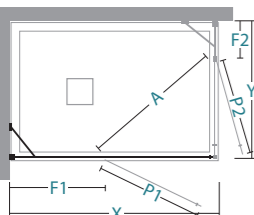

apertura battente  
swing door

| X/Y     | 67-70 | 77-80 | 87-140 | F1/F2 | P1/P2 |  |  |   |
|---------|-------|-------|--------|-------|-------|--|--|---|
| 67-70   | A=65  |       |        | 19,6  | 46    |  |  | 1 |
| 77-80   | A=72  | A=79  |        | 19,6  | 56    |  |  | 1 |
| 87-90   | A=80  | A=85  | A=93   | 19,6  | 66    |  |  | 1 |
| 92-95   | A=80  | A=85  | A=93   | 24,6  | 66    |  |  | 1 |
| 97-100  | A=80  | A=85  | A=93   | 29,6  | 66    |  |  | 1 |
| 107-110 | A=80  | A=85  | A=93   | 39,6  | 66    |  |  | 1 |
| 117-120 | A=80  | A=85  | A=93   | 49,6  | 66    |  |  | 1 |
| 137-140 | A=80  | A=85  | A=93   | 69,6  | 66    |  |  | 2 |

X / Y lunghezza parete doccia \ shower wall length  
A spazio d'entrata \ entrance space  
P1 / P2 lunghezza porta \ door length  
F1 / F2 lunghezza lato fisso \ fixed side length

attenzione      warning

Il prezzo della H speciale va trovato nella tabella Misure speciali L / H in base alla L della parete doccia

Special price for H is to be found in **Special sizes L / H** as per L needed size

Il prezzo è inteso per lato

Prices are to be intended for one side

Incluso: supporto di rinforzo regolabile e snodato

Included: adjustable, articulated supporting bar

Specificare se installato a pavimento

Specify any floor installation

FO-ABA+FO-ABA montato ad angolo su piatto doccia: considerare la misura L appena inferiore di entrambi i lati

FO-ABA+FO-ABA corner installation on tray: consider the lower sizes for both sides

| Misure speciali<br>Special size                         | Disponibilità<br>Availability |   |   |  |
|---|-------------------------------|---|---|--|
| H max 210 cm<br>L min 61 cm<br>L max 140 cm             | STOCK                         | Tcrom®                                  |   |  |
| Profilo di compensazione 3 cm<br>Extension profile 3 cm |                               | Sigillante SPARTAN®<br>Sealant SPARTAN® |   |  |
| 35A010200   | €                             | 36B010010                               | € |  |

| 05             | 11    | 12     | 16       | 24    | 25    | 26   | 27    | 28         | 29   | 30          | 31           | 32       | 34         |
|----------------|-------|--------|----------|-------|-------|------|-------|------------|------|-------------|--------------|----------|------------|
| acrilico satin | flack | reflex | satinato | nigol | flute | wave | alon  | fumè brown | fumè | trasparente | extrachiario | cincillà | stampato C |
| origin         |       |        | abitat   |       |       |      | vogue |            |      |             |              |          |            |

59 Nero / 60 Bianco      27 Tcrom® / 21 Tinox® / 22 Tbronz®      61 Orosatinato / 62 Ororosa / 63 Cromonero / 64 Franciacorta / 65 Rame / 66 Brownie / Colori

Approfondimenti  
Insights



|   |     |
|---|-----|
| Indice<br>Index                           | 3   |
| Legenda simboli<br>Icons legend           | 11  |
| Profili - Vetri<br>Profiles - Glasses     | 21  |
| Ricambi<br>Spare parts                    | 406 |
| Profili speciali<br>Special profiles      | 434 |
| Schede rilievo misure<br>Measurement form | 444 |

## CON TELAIO WITH FRAME



Porta saloon installazione in nicchia  
profilo Brownie / vetro Trasparente  
Piatto doccia ARTURO

Saloon door niche installation  
Brownie profile / Transparent glass  
Shower tray ARTURO

## ELIO

Sistema ad ante scorrevoli e pivot, dai profili sottilissimi e dal gusto sofisticato. Design leggero ma struttura resistente. L'installazione risulta semplice, il vetro da 6 mm conferisce a Elio la giusta facilità di trasporto e montaggio garantendo al contempo sicurezza e durata. Il sistema a singolo profilo a muro per le ante scorrevoli consente di compensare gli eventuali fuori squadra direttamente sulla lastra.

Sliding and hinged door system with extra-slim profiles and sophisticated taste. A lightweight design with a sturdy structure. Installation is simple, the 6mm glass provides the right ease of transportation and assembly while ensuring safety and durability. The single wall profile system for sliding doors makes it possible to compensate for any out-of-squareness directly on the pane.



01



02



03

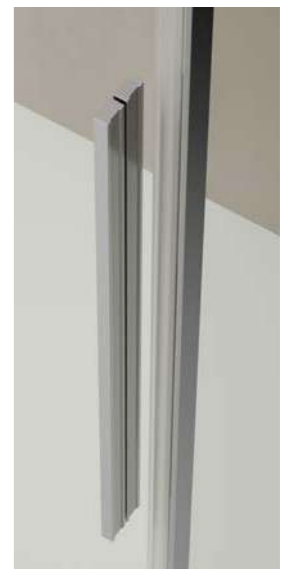

04



05

**01** giunzione binari a 45° | **02** congiunzione binario e profilo verticale diretta senza raccordi | **03** sgancio facilitato dell'anta con sistema a pulsante | **04** maniglia piena interna/esterna, lunghezza 50cm, interasse 32cm | **05** cerniera in lega metallica con apertura 150°

**01** 45° track junction | **02** direct track and vertical profile connection without connectors | **03** simplified door release system with button | **04** full 50cm internal/external, handle interaxe 32cm | **05** metal alloy hinge with 150° opening



### CARATTERISTICHE FEATURES

- H cm 200** ALTEZZA PARETI DOCCIA  
SHOWER DOOR HEIGHT
- 6 mm** SPESSORE LASTRA  
GLASS DEPTH
- NON REVERSIBILE**  
NON-REVERSIBLE

### INFO TECNICHE TECHNICAL INFORMATION

- REGOLAZIONE FUORI SQUADRO**  
OFF-SQUARE REGULATION
- EST cm** ESTENSIBILITÀ 1/1,5/3  
EXSTENSIBILITY 1/1,5/3
- SGANCIO RAPIDO**  
QUICK-RELEASE
- CHIUSURA MAGNETICA**  
MAGNETIC CLOSURE
- PROFILO MAGNETICO**  
MAGNETIC PROFILE
- PROFILO TENUTA ACQUA**  
SEAL WATER PROFILE
- MANIGLIE ESTERNA/INTERNA**  
EXTERNAL/INTERNAL HANDLES
- TRATTAMENTO NEVERDROP®**  
NEVERDROP® TREATMENT
- MISURE SPECIALI**  
SPECIAL SIZES

### Finiture profili

#### ORIGIN

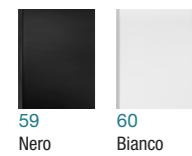

### Profiles finishing

#### ABITAT



#### VOGUE

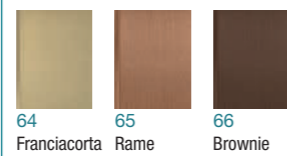
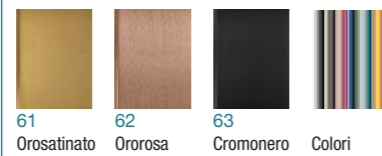

### Vetri

### Glasses

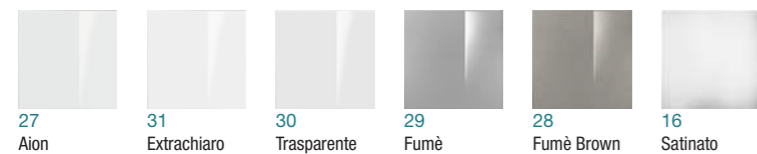

### in nicchia

EL-PSC

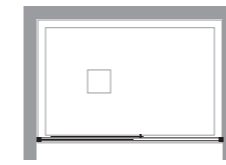

EL-PSCC

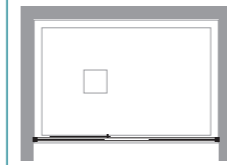

### niche

EL-PBA

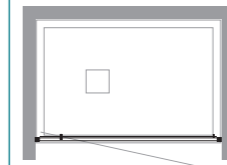

EL-PBAL

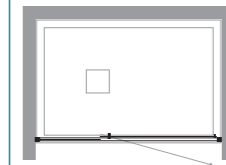

EL-PSA2

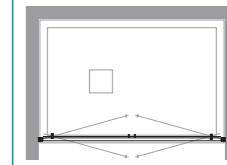

### ad angolo

EL-PSCF+EL-F

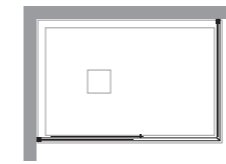

2xEL-ASC

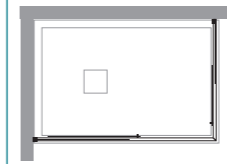

### corner

EL-PBAF+EL-FB

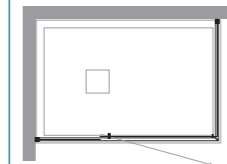

EL-PBA+EL-FA

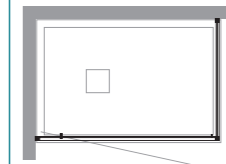

EL-PBAL+EL-FA

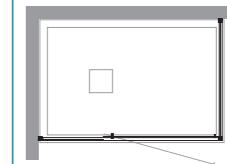

EL-PSA2+EL-FA

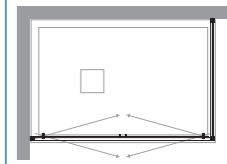

### ad angolo

EL-PBAL+2xEL-FA

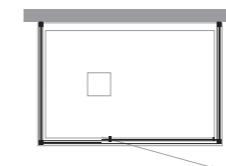

### corner

### profili

### profiles

per/for **EL: PSC-PSCF-ASC-F**



profilo a muro 1681

wall profile 1681

per/for **EL-PSCC**



profilo a muro 1681 + profilo allungamento 1682

wall profile 1681 + extension profile 1682

per/for **EL: PBA-PSA2-PBAL**

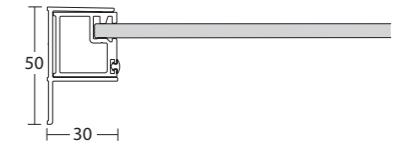

profilo a muro 1748

wall profile 1748

### importante

### important

ordini per pareti doccia speciali senza relativo disegno  
**NON** vengono prodotti

orders for special shower walls without related design are  
**NOT** produced







SX  
LH





DX  
RH



incluso



included

disponibile

available

installazioni

ad angolo corner  
EL-PSCF+EL-F



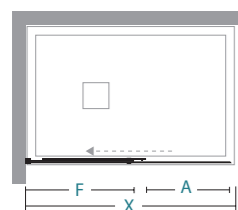

installations

informazioni



apertura scorrevole  
sliding door

informations

|             | X  | A  | F |  |  |  |  |  |  |  |
|-------------|----|----|---|--|--|--|--|--|---|---|
| 98,5-99,5   | 41 | 49 |   |  |  |  |  |  | 1   | 37  |
| 108,5-109,5 | 44 | 56 |   |  |  |  |  |  | 1   | 41  |
| 118,5-119,5 | 49 | 61 |   |  |  |  |  |  | 1   | 44  |
| 128,5-129,5 | 54 | 66 |   |  |  |  |  |  | 2   | 47  |
| 138,5-139,5 | 54 | 76 |   |  |  |  |  |  | 2   | 50  |
| 148,5-149,5 | 64 | 76 |   |  |  |  |  |  | 2   | 53  |
| 158,5-159,5 | 64 | 86 |   |  |  |  |  |  | 2   | 55  |

X lunghezza parete doccia\ shower wall length  
A spazio d'entrata\ entrance space  
F lunghezza lato fisso\ fixed side length

Misure standard

| Codice SX<br>LH Code | Codice DX<br>RH Code | estensibilità<br>extension | Finiture profili<br>Profiles finishing | 30 | 16 | 29 | 28 | 31 |
|----------------------|----------------------|----------------------------|--|----|----|----|----|----|
| 03P250100            | 03P240100            | 98,5-99,5                  | origin<br>abitat<br>vogue              |    |    |    |    |    |
| 03P250110            | 03P240110            | 108,5-109,5                | origin<br>abitat<br>vogue              |    |    |    |    |    |
| 03P250120            | 03P240120            | 118,5-119,5                | origin<br>abitat<br>vogue              |    |    |    |    |    |
| 03P250130            | 03P240130            | 128,5-129,5                | origin<br>abitat<br>vogue              |    |    |    |    |    |
| 03P250140            | 03P240140            | 138,5-139,5                | origin<br>abitat<br>vogue              |    |    |    |    |    |
| 03P250150            | 03P240150            | 148,5-149,5                | origin<br>abitat<br>vogue              |    |    |    |    |    |
| 03P250160            | 03P240160            | 158,5-159,5                | origin<br>abitat<br>vogue              |    |    |    |    |    |

Misure speciali L

| Codice SX<br>LH Code | Codice DX<br>RH Code | su misura<br>bespoke | Finiture profili<br>Profiles finishing | 30 | 16 | 29 | 28 | 27 | 31 |
|----------------------|----------------------|----------------------|--|----|----|----|----|----|----|
| 03P259001            | 03P249001            | 90 < L < 98          | origin<br>abitat<br>vogue              |    |    |    |    |    |    |
| 03P259001            | 03P249001            | 99 < L < 118         | origin<br>abitat<br>vogue              |    |    |    |    |    |    |
| 03P259001            | 03P249001            | 119 < L < 138        | origin<br>abitat<br>vogue              |    |    |    |    |    |    |
| 03P259001            | 03P249001            | 139 < L < 159        | origin<br>abitat<br>vogue              |    |    |    |    |    |    |

attenzione

Il prezzo della L speciale va trovato nella tabella Misure speciali L in base alla L della parete doccia

Special price for L is to be found in Special sizes L as per L needed size

warning

Misure speciali

Special size  
L min 90 cm  
L max 159 cm

Disponibilità

Availability  
STOCK Tcrom®+Tinox®

supplementi

Profilo di compensazione 1 cm  
Extension profile 1 cm

€ 35A020200

supplements

Sigillante SPARTAN®  
Sealant SPARTAN®

€ 36B010010

Approfondimenti  
Insights



|   |     |
|---|-----|
| Indice<br>Index                           | 3   |
| Legenda simboli<br>Icons legend           | 11  |
| Profili - Vetri<br>Profiles - Glasses     | 21  |
| Ricambi<br>Spare parts                    | 406 |
| Profili speciali<br>Special profiles      | 434 |
| Schede rilievo misure<br>Measurement form | 444 |

|                               |                                    |                |  |             |            |            |                  |            |                   |                    |                |                  |    |
|-------------------------------|------------------------------------|----------------|--|-------------|------------|------------|------------------|------------|-------------------|--------------------|----------------|------------------|----|
| 05<br>acrilico satin<br>flack | 11<br>reflex                       | 12<br>satinato | 16<br>nigol  | 24<br>flute | 25<br>wave | 26<br>aion | 27<br>fumè brown | 28<br>fumè | 29<br>trasparente | 30<br>extrachiario | 31<br>cincillà | 32<br>stampato C | 34 |
| origin                        | abitat                             |                | vogue  |             |            |            |                  |            |                   |                    |                |                  |    |
| 59 Nero / 60 Bianco           | 27 Tcrom® / 21 Tinox® / 22 Tbronz® |                | 61 Orosatinato / 62 Ororosa / 63 Cromonero / 64 Franciacorta / 65 Rame / 66 Brownie / Colori |             |            |            |                  |            |                   |                    |                |                  |    |





SX  
LH



DX  
RH

incluso      included

disponibile      available

installazioni

ad angolo      corner  
EL-F+EL-PSCF



informazioni

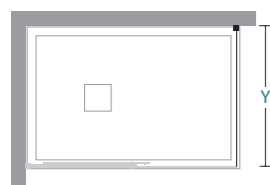

Y      lunghezza parete doccia\ shower wall length

installations

informations

| Y         |  |  |  |  |  |   |    |
|-----------|--|--|--|--|--|---|----|
| 68,5-69,5 |  |  |  |  |  | 1 | 29 |
| 73,5-74,5 |  |  |  |  |  | 1 | 30 |
| 78,5-79,5 |  |  |  |  |  | 1 | 32 |
| 83,5-84,5 |  |  |  |  |  | 1 | 33 |
| 88,5-89,5 |  |  |  |  |  | 1 | 35 |
| 98,5-99,5 |  |  |  |  |  | 1 | 38 |

Misure standard

Standard sizes

| Codice SX<br>LH Code | Codice DX<br>RH Code | estensibilità<br>extension | Finiture profili<br>Profiles finishing | 30 | 16 | 29 | 28 | 31 |
|----------------------|----------------------|----------------------------|--|----|----|----|----|----|
| 03F250070            | 03F240070            | 68,5-69,5                  | origin<br>abitat<br>vogue              |    |    |    |    |    |
| 03F250075            | 03F240075            | 73,5-74,5                  | origin<br>abitat<br>vogue              |    |    |    |    |    |
| 03F250080            | 03F240080            | 78,5-79,5                  | origin<br>abitat<br>vogue              |    |    |    |    |    |
| 03F250085            | 03F240085            | 83,5-84,5                  | origin<br>abitat<br>vogue              |    |    |    |    |    |
| 03F250090            | 03F240090            | 88,5-89,5                  | origin<br>abitat<br>vogue              |    |    |    |    |    |
| 03F250100            | 03F240100            | 98,5-99,5                  | origin<br>abitat<br>vogue              |    |    |    |    |    |

Misure speciali L

Special sizes L

| Codice SX<br>LH Code | Codice DX<br>RH Code | su misura<br>bespoke | Finiture profili<br>Profiles finishing | 30 | 16 | 29 | 28 | 27 | 31 | 12 |
|----------------------|----------------------|----------------------|--|----|----|----|----|----|----|----|
| 03F259001            | 03F249001            | 20 < L < 40          | origin<br>abitat<br>vogue              |    |    |    |    |    |    |    |
| 03F259001            | 03F249001            | 41 < L < 60          | origin<br>abitat<br>vogue              |    |    |    |    |    |    |    |
| 03F259001            | 03F249001            | 61 < L < 80          | origin<br>abitat<br>vogue              |    |    |    |    |    |    |    |
| 03F259001            | 03F249001            | 81 < L < 100         | origin<br>abitat<br>vogue              |    |    |    |    |    |    |    |

attenzione

Il prezzo della L speciale va trovato nella tabella Misure speciali L in base alla L della parete doccia

Special price for L is to be found in Special sizes L as per L needed size

warning

Il profilo di battuta è contenuto nell'imballo di EL-PSCF

The rebate profile is contained in the EL-PSCF packaging

Misure speciali  
Special size

L min 20 cm  
L max 100 cm

Disponibilità  
Availability

STOCK Tcrom®  
STOCK Tcrom®+Tinox®

supplementi

Profilo di compensazione 1 cm  
Extension profile 1 cm

€

35A020200

supplements

Sigillante SPARTAN®  
Sealant SPARTAN®

€

36B010010

Approfondimenti  
Insights



|   |     |
|---|-----|
| Indice<br>Index                           | 3   |
| Legenda simboli<br>Icons legend           | 11  |
| Profili - Vetri<br>Profiles - Glasses     | 21  |
| Ricambi<br>Spare parts                    | 406 |
| Profili speciali<br>Special profiles      | 434 |
| Schede rilievo misure<br>Measurement form | 444 |

|                               |              |              |                |             |             |            |            |                  |            |                   |                    |                |                  |
|-------------------------------|--------------|--------------|----------------|-------------|-------------|------------|------------|------------------|------------|-------------------|--------------------|----------------|------------------|
| 05<br>acrilico satin<br>flack | 11<br>reflex | 12<br>reflex | 16<br>satinato | 24<br>nigol | 25<br>flute | 26<br>wave | 27<br>alou | 28<br>fumè brown | 29<br>fumè | 30<br>trasparente | 31<br>extrachiario | 32<br>cincillà | 34<br>stampato C |
|-------------------------------|--------------|--------------|----------------|-------------|-------------|------------|------------|------------------|------------|-------------------|--------------------|----------------|------------------|

|                               |  |   |
|-------------------------------|--|---|
| origin<br>59 Nero / 60 Bianco | abitat<br>27 Tcrom® / 21 Tinox® / 22 Tbronz® | vogue<br>61 Orosatinato / 62 Ororosa / 63 Cromonero / 64 Franciacorta / 65 Rame / 66 Brownie / Colori |
|-------------------------------|--|---|



SX  
LH

DX  
RH

H cm  
200

6 mm

REV

incluso

1,5 cm

included

1 cm

disponibile

1 cm

available

1 cm

**installazioni**  
in nicchia  
EL-PSC

**installations**  
niche

**informazioni**

apertura scorrevole  
sliding door

**informations**

|           | X  | A  | F |  |  |  |  |  |   |    |
|-----------|----|----|---|--|--|--|--|--|---|----|
| 97,5-99   | 43 | 48 |   |  |  |  |  |  | 1 | 38 |
| 107,5-109 | 43 | 58 |   |  |  |  |  |  | 1 | 42 |
| 117,5-119 | 53 | 58 |   |  |  |  |  |  | 1 | 45 |
| 127,5-129 | 53 | 68 |   |  |  |  |  |  | 2 | 48 |
| 137,5-139 | 63 | 68 |   |  |  |  |  |  | 2 | 51 |
| 147,5-149 | 63 | 78 |   |  |  |  |  |  | 2 | 54 |
| 157,5-159 | 63 | 88 |   |  |  |  |  |  | 2 | 57 |

X lunghezza parete doccia\ shower wall length  
A spazio d'entrata\ entrance space  
F lunghezza lato fisso\ fixed side length

**Misure standard**

Standard sizes

| Codice SX<br>LH Code | Codice DX<br>RH Code | estensibilità<br>extension | Finiture profili<br>Profiles finishing | 30 | 16 | 29 | 28 | 31 |
|----------------------|----------------------|----------------------------|--|----|----|----|----|----|
| 03P210100            | 03P200100            | 97,5-99                    | origin<br>abitat<br>vogue              |    |    |    |    |    |
| 03P210110            | 03P200110            | 107,5-109                  | origin<br>abitat<br>vogue              |    |    |    |    |    |
| 03P210120            | 03P200120            | 117,5-119                  | origin<br>abitat<br>vogue              |    |    |    |    |    |
| 03P210130            | 03P200130            | 127,5-129                  | origin<br>abitat<br>vogue              |    |    |    |    |    |
| 03P210140            | 03P200140            | 137,5-139                  | origin<br>abitat<br>vogue              |    |    |    |    |    |
| 03P210150            | 03P200150            | 147,5-149                  | origin<br>abitat<br>vogue              |    |    |    |    |    |
| 03P210160            | 03P200160            | 157,5-159                  | origin<br>abitat<br>vogue              |    |    |    |    |    |

**Misure speciali L**

Special sizes L

| Codice SX<br>LH Code | Codice DX<br>RH Code | su misura<br>bespoke | Finiture profili<br>Profiles finishing | 30 | 16 | 29 | 28 | 27 | 31 |
|----------------------|----------------------|----------------------|--|----|----|----|----|----|----|
| 03P219001            | 03P209001            | 90 < L < 99          | origin<br>abitat<br>vogue              |    |    |    |    |    |    |
| 03P219001            | 03P209001            | 100 < L < 119        | origin<br>abitat<br>vogue              |    |    |    |    |    |    |
| 03P219001            | 03P209001            | 120 < L < 139        | origin<br>abitat<br>vogue              |    |    |    |    |    |    |
| 03P219001            | 03P209001            | 140 < L < 159        | origin<br>abitat<br>vogue              |    |    |    |    |    |    |

**attenzione**

warning

Il prezzo della L speciale va trovato nella tabella Misure speciali L in base alla L della parete doccia

Special price for L is to be found in Special sizes L as per L needed size

Misure speciali  
Special size

|       |        |
|-------|--------|
| L min | 90 cm  |
| L max | 159 cm |

**supplementi**

supplements

|   |   |   |   |
|---|---|---|---|
| Profilo di compensazione 1 cm<br>Extension profile 1 cm | Sigillante SPARTAN®<br>Sealant SPARTAN® | € | € |
| 35A020200   | 36B010010                               |   |   |

|                |       |        |          |       |       |      |      |            |      |             |              |          |            |
|----------------|-------|--------|----------|-------|-------|------|------|------------|------|-------------|--------------|----------|------------|
| 05             | 11    | 12     | 16       | 24    | 25    | 26   | 27   | 28         | 29   | 30          | 31           | 32       | 34         |
| acrilico satin | flack | reflex | satinato | nigol | flute | wave | alon | fumè brown | fumè | trasparente | extrachiario | cincillà | stampato C |

|                     |                                    |  |
|---------------------|------------------------------------|--|
| origin              | abitat                             | vogue  |
| 59 Nero / 60 Bianco | 27 Tcrom® / 21 Tinox® / 22 Tbronz® | 61 Orosatinato / 62 Ororosa / 63 Cromonero / 64 Franciacorta / 65 Rame / 66 Brownie / Colori |

Approfondimenti  
Insights



|   |     |
|---|-----|
| Indice<br>Index                           | 3   |
| Legenda simboli<br>Icons legend           | 11  |
| Profili - Vetri<br>Profiles - Glasses     | 21  |
| Ricambi<br>Spare parts                    | 406 |
| Profili speciali<br>Special profiles      | 434 |
| Schede rilievo misure<br>Measurement form | 444 |







SX  
LH





DX  
RH



incluso



included

disponibile

available

installazioni

ad angolo corner  
EL-ASC+EL-ASC



installations

informazioni

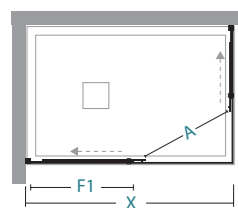

apertura scorrevole  
sliding door

informations

| X/Y         | 68,5-69,5 | 73,5-74,5 | 78,5-79,5 | 88,5-89,5 | 98,5-99,5 | 118,5 +1 | F1/F2 |   |    |
|-------------|-----------|-----------|-----------|-----------|-----------|----------|-------|---|----|
| 68,5-69,5   | A=39      |           |           |           |           |          | 32    | 1 | 28 |
| 73,5-74,5   | A=39      | A=39      |           |           |           |          | 36    | 1 | 29 |
| 78,5-79,5   | A=41      | A=41      | A=46      |           |           |          | 36    | 1 | 31 |
| 88,5-89,5   | A=41      | A=41      | A=46      | A=46      |           |          | 47    | 1 | 34 |
| 98,5-99,5   | A=41      | A=41      | A=46      | A=46      | A=44,5    |          | 56    | 1 | 37 |
| 118,5-119,5 | A=41      | A=41      | A=46      | A=46      | A=44,5    | A=44,5   | 76    | 1 | 43 |

X / Y lunghezza parete doccia \ shower wall length  
A spazio d'entrata \ entrance space  
F1 / F2 lunghezza lato fisso \ fixed side length

Misure standard

| Codice SX<br>LH Code | Codice DX<br>RH Code | estensibilità<br>extension | Finiture profili<br>Profiles finishing | 30 | 16 | 29 | 28 | 31 |
|----------------------|----------------------|----------------------------|--|----|----|----|----|----|
| 03A210070            | 03A200070            | 68,5-69,5                  | origin<br>abitat<br>vogue              |    |    |    |    |    |
| 03A210075            | 03A200075            | 73,5-74,5                  | origin<br>abitat<br>vogue              |    |    |    |    |    |
| 03A210080            | 03A200080            | 78,5-79,5                  | origin<br>abitat<br>vogue              |    |    |    |    |    |
| 03A210090            | 03A200090            | 88,5-89,5                  | origin<br>abitat<br>vogue              |    |    |    |    |    |
| 03A210100            | 03A200100            | 98,5-99,5                  | origin<br>abitat<br>vogue              |    |    |    |    |    |
| 03A210120            | 03A200120            | 118,5-119,5                | origin<br>abitat<br>vogue              |    |    |    |    |    |

Misure speciali L

| Codice SX<br>LH Code | Codice DX<br>RH Code | su misura<br>bespoke | Finiture profili<br>Profiles finishing | 30 | 16 | 29 | 28 | 27 | 31 |
|----------------------|----------------------|----------------------|--|----|----|----|----|----|----|
| 03A219001            | 03A209001            | 50 < L < 80          | origin<br>abitat<br>vogue              |    |    |    |    |    |    |
| 03A219001            | 03A209001            | 81 < L < 110         | origin<br>abitat<br>vogue              |    |    |    |    |    |    |
| 03A219001            | 03A209001            | 111 < L < 140        | origin<br>abitat<br>vogue              |    |    |    |    |    |    |

attenzione

Il prezzo della L speciale va trovato nella tabella Misure speciali L in base alla L della parete doccia

Special price for L is to be found in Special sizes L as per L needed size

warning

Il prezzo è inteso per lato

Prices are to be intended for one side

Misure speciali

|       |        |
|-------|--------|
| L min | 50 cm  |
| L max | 140 cm |

Disponibilità

|       |        |
|-------|--------|
| STOCK | Tcrom® |
|-------|--------|

supplementi

Profilo di compensazione 1 cm  
Extension profile 1 cm

|   |           |
|---|-----------|
| € | 35A020200 |
|---|-----------|

supplements

Sigillante SPARTAN®  
Sealant SPARTAN®

|   |           |
|---|-----------|
| € | 36B010010 |
|---|-----------|

Approfondimenti  
Insights



|   |     |
|---|-----|
| Indice<br>Index                           | 3   |
| Legenda simboli<br>Icons legend           | 11  |
| Profili - Vetri<br>Profiles - Glasses     | 21  |
| Ricambi<br>Spare parts                    | 406 |
| Profili speciali<br>Special profiles      | 434 |
| Schede rilievo misure<br>Measurement form | 444 |

| 05                  | 11                                 | 12     | 16       | 24   | 25    | 26   | 27   | 28         | 29   | 30          | 31           | 32       | 34         |
|---------------------|------------------------------------|--------|----------|--|-------|------|------|------------|------|-------------|--------------|----------|------------|
| acrilico satin      | flack                              | reflex | satinato | nigol  | flute | wave | alon | fumè brown | fumè | trasparente | extrachiario | cincillà | stampato C |
| origin              | abitat                             |        |          | vogue  |       |      |      |            |      |             |              |          |            |
| 59 Nero / 60 Bianco | 27 Tcrom® / 21 Tinox® / 22 Tbronz® |        |          | 61 Orosatinato / 62 Ororosa / 63 Cromonero / 64 Franciacorta / 65 Rame / 66 Brownie / Colori |       |      |      |            |      |             |              |          |            |

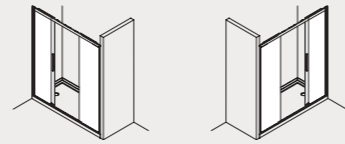

SX LH      DX RH

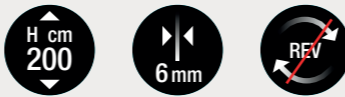

incluso      included



disponibile      available



installazioni

in nicchia      niche  
EL-PSCC

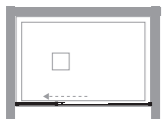

installations

informazioni

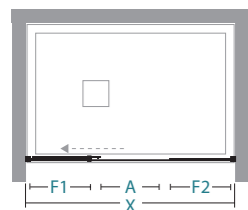

scorrevole centrale  
central sliding door

informations

|           | X  | A  | F1 | F2 |  |  |  |   |    |
|-----------|----|----|----|----|--|--|--|---|----|
| 146,5-150 | 42 | 49 | 49 |    |  |  |  | 2 | 60 |
| 156,5-160 | 47 | 52 | 52 |    |  |  |  | 2 | 63 |
| 166,5-170 | 47 | 57 | 57 |    |  |  |  | 2 | 66 |
| 176,5-180 | 51 | 60 | 60 |    |  |  |  | 2 | 70 |
| 186,5-190 | 57 | 62 | 62 |    |  |  |  | 2 | 72 |
| 196,5-200 | 57 | 67 | 67 |    |  |  |  | 2 | 75 |

X lunghezza parete doccia\ shower wall length  
A spazio d'entrata\ entrance space  
F1 / F2 lunghezza lato fisso\ fixed side length

Misure standard

Standard sizes

| Codice SX<br>LH Code | Codice DX<br>RH Code | estensibilità<br>extension | Finiture profili<br>Profiles finishing | 30 | 16 | 29 | 28 | 31 |
|----------------------|----------------------|----------------------------|--|----|----|----|----|----|
| 03P270150            | 03P260150            | 146,5-150                  | origin<br>abitat<br>vogue              |    |    |    |    |    |
| 03P270160            | 03P260160            | 156,5-160                  | origin<br>abitat<br>vogue              |    |    |    |    |    |
| 03P270170            | 03P260170            | 166,5-170                  | origin<br>abitat<br>vogue              |    |    |    |    |    |
| 03P270180            | 03P260180            | 176,5-180                  | origin<br>abitat<br>vogue              |    |    |    |    |    |
| 03P270190            | 03P260190            | 186,5-190                  | origin<br>abitat<br>vogue              |    |    |    |    |    |
| 03P270200            | 03P260200            | 196,5-200                  | origin<br>abitat<br>vogue              |    |    |    |    |    |

Misure speciali L

Special sizes L

| Codice SX<br>LH Code | Codice DX<br>RH Code | su misura<br>bespoke | Finiture profili<br>Profiles finishing | 30 | 16 | 29 | 28 | 27 | 31 |
|----------------------|----------------------|----------------------|--|----|----|----|----|----|----|
| 03P279001            | 03P269001            | 150 < L < 169        | origin<br>abitat<br>vogue              |    |    |    |    |    |    |
| 03P279001            | 03P269001            | 170 < L < 189        | origin<br>abitat<br>vogue              |    |    |    |    |    |    |
| 03P279001            | 03P269001            | 190 < L < 200        | origin<br>abitat<br>vogue              |    |    |    |    |    |    |

attenzione

Il prezzo della L speciale va trovato nella tabella Misure speciali L in base alla L della parete doccia

Special price for L is to be found in Special sizes L as per L needed size

warning

Misure speciali  
Special size

L min 150 cm  
L max 200 cm

supplementi

Profilo di compensazione 1 cm  
Extension profile 1 cm

€ 35A020200

supplements

Sigillante SPARTAN®  
Sealant SPARTAN®

€ 36B010010

Approfondimenti  
Insights



|   |     |
|---|-----|
| Indice<br>Index                           | 3   |
| Legenda simboli<br>Icons legend           | 11  |
| Profili - Vetri<br>Profiles - Glasses     | 21  |
| Ricambi<br>Spare parts                    | 406 |
| Profili speciali<br>Special profiles      | 434 |
| Schede rilievo misure<br>Measurement form | 444 |

|                     |                                    |        |          |  |       |      |      |            |      |             |              |          |            |
|---------------------|------------------------------------|--------|----------|--|-------|------|------|------------|------|-------------|--------------|----------|------------|
| 05                  | 11                                 | 12     | 16       | 24   | 25    | 26   | 27   | 28         | 29   | 30          | 31           | 32       | 34         |
| acrilico satin      | flack                              | reflex | satinato | nigol  | flute | wave | alon | fumè brown | fumè | trasparente | extrachiario | cincillà | stampato C |
| origin              | abitat                             |        |          | vogue  |       |      |      |            |      |             |              |          |            |
| 59 Nero / 60 Bianco | 27 Tcrom® / 21 Tinox® / 22 Tbronz® |        |          | 61 Orosatinato / 62 Ororosa / 63 Cromonero / 64 Franciacorta / 65 Rame / 66 Brownie / Colori |       |      |      |            |      |             |              |          |            |



SX  
LH

DX  
RH

H cm  
200

6 mm

REVO

incluso

included

1 cm

U

NEVERDROP

L

disponibile

available

1 cm

screws

## installazioni

ad angolo corner  
EL-PBAF+EL-FB

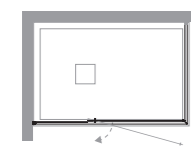

## informazioni

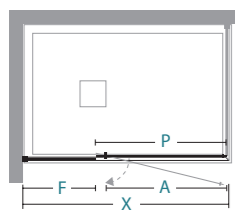

Y lunghezza parete doccia\ shower wall length

## installations

## informations

|             | X  | A  | F  | P |  |  |  |  |  |   |    |
|-------------|----|----|----|---|--|--|--|--|--|---|----|
| 98,5-99,5   | 49 | 39 | 60 |   |  |  |  |  |  | 1 | 37 |
| 108,5-109,5 | 49 | 49 | 60 |   |  |  |  |  |  | 1 | 41 |
| 118,5-119,5 | 59 | 49 | 70 |   |  |  |  |  |  | 1 | 44 |
| 128,5-129,5 | 59 | 59 | 70 |   |  |  |  |  |  | 2 | 47 |
| 138,5-139,5 | 69 | 59 | 80 |   |  |  |  |  |  | 2 | 50 |
| 148,5-149,5 | 69 | 69 | 80 |   |  |  |  |  |  | 2 | 53 |
| 158,5-159,5 | 69 | 79 | 80 |   |  |  |  |  |  | 2 | 55 |

## EL-PBAF

INSTALLAZIONE AD ANGOLO  
CORNER INSTALLATION

## Misure standard

| Codice SX<br>LH Code |  | Codice DX<br>RH Code |  | estensibilità<br>extension | Finiture profili<br>Profiles finishing | 30 | 16 | 29 | 28 | 31 |
|----------------------|--|----------------------|--|----------------------------|--|----|----|----|----|----|
| 03P330100            |  | 03P320100            |  | 98,5-99,5                  | origin<br>abitat<br>vogue              |    |    |    |    |    |
| 03P330110            |  | 03P320110            |  | 108,5-109,5                | origin<br>abitat<br>vogue              |    |    |    |    |    |
| 03P330120            |  | 03P320120            |  | 118,5-119,5                | origin<br>abitat<br>vogue              |    |    |    |    |    |
| 03P330130            |  | 03P320130            |  | 128,5-129,5                | origin<br>abitat<br>vogue              |    |    |    |    |    |
| 03P330140            |  | 03P320140            |  | 138,5-139,5                | origin<br>abitat<br>vogue              |    |    |    |    |    |
| 03P330150            |  | 03P320150            |  | 148,5-149,5                | origin<br>abitat<br>vogue              |    |    |    |    |    |
| 03P330160            |  | 03P320160            |  | 158,5-159,5                | origin<br>abitat<br>vogue              |    |    |    |    |    |

## Standard sizes

## Misure speciali L

| Codice SX<br>LH Code |  | Codice DX<br>RH Code |  | su misura<br>bespoke | Finiture profili<br>Profiles finishing | 30 | 16 | 29 | 28 | 27 | 31 |
|----------------------|--|----------------------|--|----------------------|--|----|----|----|----|----|----|
| 03P339001            |  | 03P329001            |  | 90 < L < 98          | origin<br>abitat<br>vogue              |    |    |    |    |    |    |
| 03P339001            |  | 03P329001            |  | 99 < L < 118         | origin<br>abitat<br>vogue              |    |    |    |    |    |    |
| 03P339001            |  | 03P329001            |  | 119 < L < 138        | origin<br>abitat<br>vogue              |    |    |    |    |    |    |
| 03P339001            |  | 03P329001            |  | 139 < L < 160        | origin<br>abitat<br>vogue              |    |    |    |    |    |    |

## Special sizes L

## attenzione

Il prezzo della L speciale va trovato nella tabella Misure speciali L in base alla L della parete doccia

Special price for L is to be found in Special sizes L as per L needed size

## warning

Misure speciali  
Special size

L min 90 cm  
L max 160 cm

## supplementi

Profilo di compensazione 1 cm  
Extension profile 1 cm

35A020200 €

## supplements

Sigillante SPARTAN®  
Sealant SPARTAN®

36B010010 €

Approfondimenti  
Insights

|   |     |
|---|-----|
| Indice<br>Index                           | 3   |
| Legenda simboli<br>Icons legend           | 11  |
| Profili - Vetri<br>Profiles - Glasses     | 21  |
| Ricambi<br>Spare parts                    | 406 |
| Profili speciali<br>Special profiles      | 434 |
| Schede rilievo misure<br>Measurement form | 444 |

|                               |              |                |             |             |            |            |                  |            |                   |                   |                |                  |    |
|-------------------------------|--------------|----------------|-------------|-------------|------------|------------|------------------|------------|-------------------|-------------------|----------------|------------------|----|
| 05<br>acrilico satin<br>flack | 11<br>reflex | 12<br>satinato | 16<br>nigol | 24<br>flute | 25<br>wave | 26<br>aion | 27<br>fumè brown | 28<br>fumè | 29<br>trasparente | 30<br>extrachiaro | 31<br>cincillà | 32<br>stampato C | 34 |
| origin                        | abitat       |                |             |             |            | vogue      |                  |            |                   |                   |                |                  |    |

59 Nero / 60 Bianco

27 Tcrom® / 21 Tinox® / 22 Tbronz®

61 Orosatinato / 62 Ororosa / 63 Cromonero / 64 Franciacorta / 65 Rame / 66 Brownie / Colori



SX  
LH

DX  
RH

incluso

included

disponibile

available

installazioni

ad angolo corner  
EL-FB+EL-PBAF

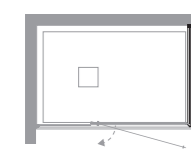

informazioni

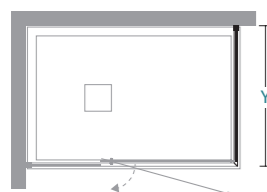

Y lunghezza parete doccia\ shower wall length

installations

informations

| Y         |  |  |  |  |  |  |  |   |    |
|-----------|--|--|--|--|--|--|--|---|----|
| 68,5-69,5 |  |  |  |  |  |  |  | 1 | 29 |
| 73,5-74,5 |  |  |  |  |  |  |  | 1 | 30 |
| 78,5-79,5 |  |  |  |  |  |  |  | 1 | 32 |
| 83,5-84,5 |  |  |  |  |  |  |  | 1 | 33 |
| 88,5-89,5 |  |  |  |  |  |  |  | 1 | 35 |
| 98,5-99,5 |  |  |  |  |  |  |  | 1 | 38 |

Misure standard

Standard sizes

| Codice SX<br>LH Code | Codice DX<br>RH Code | estensibilità<br>extension | Finiture profili<br>Profiles finishing | 30 | 16 | 29 | 28 | 31 |
|----------------------|----------------------|----------------------------|--|----|----|----|----|----|
| 03F250070            | 03F240070            | 68,5-69,5                  | origin<br>abibat<br>vogue              |    |    |    |    |    |
| 03F250075            | 03F240075            | 73,5-74,5                  | origin<br>abibat<br>vogue              |    |    |    |    |    |
| 03F250080            | 03F240080            | 78,5-79,5                  | origin<br>abibat<br>vogue              |    |    |    |    |    |
| 03F250085            | 03F240085            | 83,5-84,5                  | origin<br>abibat<br>vogue              |    |    |    |    |    |
| 03F250090            | 03F240090            | 88,5-89,5                  | origin<br>abibat<br>vogue              |    |    |    |    |    |
| 03F250100            | 03F240100            | 98,5-99,5                  | origin<br>abibat<br>vogue              |    |    |    |    |    |

Misure speciali L

Special sizes L

| Codice SX<br>LH Code | Codice DX<br>RH Code | su misura<br>bespoke | Finiture profili<br>Profiles finishing | 30 | 16 | 29 | 28 | 27 | 31 | 12 |
|----------------------|----------------------|----------------------|--|----|----|----|----|----|----|----|
| 03F259001            | 03F249001            | 20 < L < 40          | origin<br>abibat<br>vogue              |    |    |    |    |    |    |    |
| 03F259001            | 03F249001            | 41 < L < 60          | origin<br>abibat<br>vogue              |    |    |    |    |    |    |    |
| 03F259001            | 03F249001            | 61 < L < 80          | origin<br>abibat<br>vogue              |    |    |    |    |    |    |    |
| 03F259001            | 03F249001            | 81 < L < 100         | origin<br>abibat<br>vogue              |    |    |    |    |    |    |    |

attenzione

Il prezzo della L speciale va trovato nella tabella Misure speciali L in base alla L della parete doccia

Special price for L is to be found in Special sizes L as per L needed size

warning

Il profilo di battuta è contenuto nell'imballo di EL-PBAF

The rebate profile is contained in the EL-PBAF packaging

Misure speciali

|       |        |
|-------|--------|
| L min | 20 cm  |
| L max | 100 cm |

Disponibilità

|       |               |
|-------|---------------|
| STOCK | Tcrom®        |
| STOCK | Tcrom®+Tinox® |

supplementi

Profilo di compensazione 1 cm  
Extension profile 1 cm

€

35A020200

supplements

Sigillante SPARTAN®  
Sealant SPARTAN®

€

36B010010

Approfondimenti  
Insights



|   |     |
|---|-----|
| Indice<br>Index                           | 3   |
| Legenda simboli<br>Icons legend           | 11  |
| Profili - Vetri<br>Profiles - Glasses     | 21  |
| Ricambi<br>Spare parts                    | 406 |
| Profili speciali<br>Special profiles      | 434 |
| Schede rilievo misure<br>Measurement form | 444 |

|                |       |        |          |       |       |      |      |            |      |             |              |          |            |
|----------------|-------|--------|----------|-------|-------|------|------|------------|------|-------------|--------------|----------|------------|
| 05             | 11    | 12     | 16       | 24    | 25    | 26   | 27   | 28         | 29   | 30          | 31           | 32       | 34         |
| acrilico satin | flack | reflex | satinato | nigol | flute | wave | alon | fumè brown | fumè | trasparente | extrachiario | cincillà | stampato C |

|                     |                                    |  |
|---------------------|------------------------------------|--|
| origin              | abibat                             | vogue  |
| 59 Nero / 60 Bianco | 27 Tcrom® / 21 Tinox® / 22 Tbronz® | 61 Orosatinato / 62 Ororosa / 63 Cromonero / 64 Franciacorta / 65 Rame / 66 Brownie / Colori |



SX  
LH

DX  
RH

H cm  
200

6 mm

REV

incluso

included

disponibile

available

installazioni

in nicchia niche  
EL-PBA

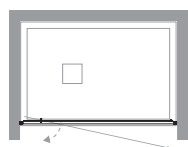

installations

ad angolo corner  
EL-PBA+EL-FA

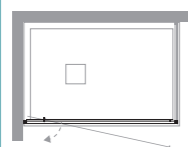

informazioni

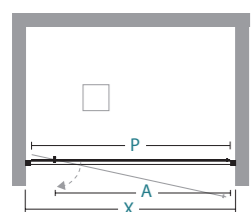

apertura battente  
swing door

informations

|        | X  | A  | P |  |  |  |  |  |   |    |
|--------|----|----|---|--|--|--|--|--|---|----|
| 67-70  | 49 | 60 |   |  |  |  |  |  | 1 | 21 |
| 72-75  | 54 | 65 |   |  |  |  |  |  | 1 | 25 |
| 77-80  | 59 | 71 |   |  |  |  |  |  | 1 | 25 |
| 87-90  | 69 | 81 |   |  |  |  |  |  | 1 | 30 |
| 97-100 | 69 | 91 |   |  |  |  |  |  | 1 | 35 |

X lunghezza parete doccia \ shower wall length  
A spazio d'entrata \ entrance space  
P lunghezza porta \ door length

Misure standard

| Codice SX<br>LH Code | Codice DX<br>RH Code | estensibilità<br>extension | Finiture profili<br>Profiles finishing | 30 | 16 | 29 | 28 | 31 |
|----------------------|----------------------|----------------------------|--|----|----|----|----|----|
| 03P310070            | 03P300070            | 67-70                      | origin<br>abitat<br>vogue              |    |    |    |    |    |
| 03P310075            | 03P300075            | 72-75                      | origin<br>abitat<br>vogue              |    |    |    |    |    |
| 03P310080            | 03P300080            | 77-80                      | origin<br>abitat<br>vogue              |    |    |    |    |    |
| 03P310090            | 03P300090            | 87-90                      | origin<br>abitat<br>vogue              |    |    |    |    |    |
| 03P310100            | 03P300100            | 97-100                     | origin<br>abitat<br>vogue              |    |    |    |    |    |

Misure speciali L

| Codice SX<br>LH Code | Codice DX<br>RH Code | su misura<br>bespoke | Finiture profili<br>Profiles finishing | 30 | 16 | 29 | 28 | 27 | 31 |
|----------------------|----------------------|----------------------|--|----|----|----|----|----|----|
| 03P319001            | 03P309001            | 60 < L < 80          | origin<br>abitat<br>vogue              |    |    |    |    |    |    |
| 03P319001            | 03P309001            | 81 < L < 100         | origin<br>abitat<br>vogue              |    |    |    |    |    |    |

attenzione

Il prezzo della L speciale va trovato nella tabella Misure speciali L in base alla L della parete doccia

Special price for L is to be found in Special sizes L as per L needed size

warning

Misure speciali  
Special size

L min 60 cm  
L max 100 cm

supplementi

Profilo di compensazione 1 cm  
Extension profile 1 cm

35A030200

Sigillante SPARTAN®  
Sealant SPARTAN®

36B010010

| 05                  | 11                                 | 12     | 16       | 24   | 25    | 26   | 27   | 28         | 29   | 30          | 31          | 32       | 34         |
|---------------------|------------------------------------|--------|----------|--|-------|------|------|------------|------|-------------|-------------|----------|------------|
| acrilico satin      | flack                              | reflex | satinato | nigol  | flute | wave | alon | fumè brown | fumè | trasparente | extrachiaro | cincillà | stampato C |
| origin              | abitat                             |        |          | vogue  |       |      |      |            |      |             |             |          |            |
| 59 Nero / 60 Bianco | 27 Tcrom® / 21 Tinox® / 22 Tbronz® |        |          | 61 Orosatinato / 62 Ororosa / 63 Cromonero / 64 Franciacorta / 65 Rame / 66 Brownie / Colori |       |      |      |            |      |             |             |          |            |

Approfondimenti  
Insights



|   |     |
|---|-----|
| Indice<br>Index                           | 3   |
| Legenda simboli<br>Icons legend           | 11  |
| Profili - Vetri<br>Profiles - Glasses     | 21  |
| Ricambi<br>Spare parts                    | 406 |
| Profili speciali<br>Special profiles      | 434 |
| Schede rilievo misure<br>Measurement form | 444 |



SX  
LH

DX  
RH

incluso      included

disponibile      available

### Misure standard

| Codice SX<br>LH Code | Codice DX<br>RH Code | estensibilità<br>extension | Finiture profili<br>Profiles finishing | 30 | 16 | 29 | 28 | 31 |
|----------------------|----------------------|----------------------------|--|----|----|----|----|----|
| 03P370100            | 03P360100            | 97-100                     | origin<br>abitat<br>vogue              |    |    |    |    |    |
| 03P370110            | 03P360110            | 107-110                    | origin<br>abitat<br>vogue              |    |    |    |    |    |
| 03P370120            | 03P360120            | 117-120                    | origin<br>abitat<br>vogue              |    |    |    |    |    |
| 03P370130            | 03P360130            | 127-130                    | origin<br>abitat<br>vogue              |    |    |    |    |    |
| 03P370140            | 03P360140            | 137-140                    | origin<br>abitat<br>vogue              |    |    |    |    |    |

### Misure speciali L

| Codice SX<br>LH Code | Codice DX<br>RH Code | su misura<br>bespoke | Finiture profili<br>Profiles finishing | 30 | 16 | 29 | 28 | 27 | 31 |
|----------------------|----------------------|----------------------|--|----|----|----|----|----|----|
| 03P379001            | 03P369001            | 90 < L < 98          | origin<br>abitat<br>vogue              |    |    |    |    |    |    |
| 03P379001            | 03P369001            | 99 < L < 118         | origin<br>abitat<br>vogue              |    |    |    |    |    |    |
| 03P379001            | 03P369001            | 119 < L < 140        | origin<br>abitat<br>vogue              |    |    |    |    |    |    |

### installazioni

in nicchia    niche  
**EL-PBAL**

ad angolo    corner  
**EL-PBAL+EL-FA**

a tre lati    three sides  
**EL-PBAL+2\*EL-FA**

### informazioni

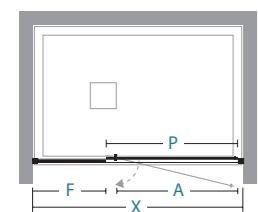

### informations

apertura scorrevole  
sliding door

|         | X  | A  | F    | P |  |  |  |  |   |    |
|---------|----|----|------|---|--|--|--|--|---|----|
| 97-100  | 49 | 34 | 59,5 |   |  |  |  |  | 1 | 35 |
| 107-110 | 49 | 44 | 59,5 |   |  |  |  |  | 1 | 38 |
| 117-120 | 59 | 44 | 69,5 |   |  |  |  |  | 1 | 40 |
| 127-130 | 59 | 54 | 69,5 |   |  |  |  |  | 2 | 45 |
| 137-140 | 59 | 64 | 69,5 |   |  |  |  |  | 2 | 48 |

- X** lunghezza parete doccia\ shower wall length
- A** spazio d'entrata\ entrance space
- F** lunghezza lato fisso\ fixed side length
- P** lunghezza porta\ door length

### attenzione

Il prezzo della **L** speciale va trovato nella tabella **Misure speciali L** in base alla **L** della parete doccia

Special price for **L** is to be found in **Special sizes L** as per **L** needed size

### warning

#### Misure speciali Special size

|              |        |
|--------------|--------|
| <b>L</b> min | 90 cm  |
| <b>L</b> max | 140 cm |

### supplementi

|   |   |           |  |  |  |  |  |  |  |
|---|---|-----------|--|--|--|--|--|--|--|
| Profilo di compensazione 1 cm<br>Extension profile 1 cm | Sigillante SPARTAN®<br>Sealant SPARTAN® |           |  |  |  |  |  |  |  |
|   | €                                       | €         |  |  |  |  |  |  |  |
| 35A030200   |   | 36B010010 |  |  |  |  |  |  |  |

| 05             | 11    | 12     | 16            | 24    | 25    | 26   | 27           | 28         | 29   | 30          | 31           | 32       | 34         |
|----------------|-------|--------|---------------|-------|-------|------|--------------|------------|------|-------------|--------------|----------|------------|
| acrilico satin | flack | reflex | satinato      | nigol | flute | wave | alon         | fumè brown | fumè | trasparente | extrachiario | cincillà | stampato C |
| <b>origin</b>  |       |        |               |       |       |      |              |            |      |             |              |          |            |
|                |       |        | <b>abitat</b> |       |       |      |              |            |      |             |              |          |            |
|                |       |        |               |       |       |      | <b>vogue</b> |            |      |             |              |          |            |

59 Nero / 60 Bianco      27 Tcrom® / 21 Tinox® / 22 Tbronz®      61 Orosatinato / 62 Ororosa / 63 Cromonero / 64 Franciacorta / 65 Rame / 66 Brownie / Colori

### Approfondimenti Insights





|   |     |
|---|-----|
| Indice<br>Index                           | 3   |
| Legenda simboli<br>Icons legend           | 11  |
| Profili - Vetri<br>Profiles - Glasses     | 21  |
| Ricambi<br>Spare parts                    | 406 |
| Profili speciali<br>Special profiles      | 434 |
| Schede rilievo misure<br>Measurement form | 444 |















incluso





included











disponibile



available



Misure standard

Standard sizes

| Codice<br>Code | estensibilità<br>extension | Finiture profili<br>Profiles finishing | 30 | 16 | 29 | 28 | 31 |
|----------------|----------------------------|--|----|----|----|----|----|
| 03P340070      | 67-70                      | origin<br>abitat<br>vogue              |    |    |    |    |    |
| 03P340075      | 72-75                      | origin<br>abitat<br>vogue              |    |    |    |    |    |
| 03P340080      | 77-80                      | origin<br>abitat<br>vogue              |    |    |    |    |    |
| 03P340090      | 87-90                      | origin<br>abitat<br>vogue              |    |    |    |    |    |
| 03P340100      | 97-100                     | origin<br>abitat<br>vogue              |    |    |    |    |    |
| 03P340110      | 107-110                    | origin<br>abitat<br>vogue              |    |    |    |    |    |
| 03P340120      | 117-120                    | origin<br>abitat<br>vogue              |    |    |    |    |    |

Misure speciali L

Special sizes L

| Codice<br>Code | su misura<br>bespoke | Finiture profili<br>Profiles finishing | 30 | 16 | 29 | 28 | 27 | 31 |
|----------------|----------------------|--|----|----|----|----|----|----|
| 03P349001      | 60 < L < 80          | origin<br>abitat<br>vogue              |    |    |    |    |    |    |
| 03P349001      | 81 < L < 100         | origin<br>abitat<br>vogue              |    |    |    |    |    |    |
| 03P349001      | 101 < L < 120        | origin<br>abitat<br>vogue              |    |    |    |    |    |    |

installazioni

installations

in nicchia  
niche  
EL-PSA2

ad angolo  
corner  
EL-PSA2+EL-FA

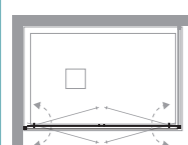
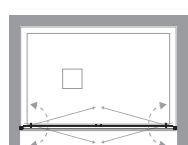

informazioni

informations

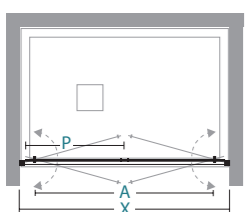

apertura saloon  
saloon door

| X       | A  | P    |  |  |  |  |  |  |   |    |
|---------|----|------|--|--|--|--|--|--|---|----|
| 67-70   | 49 | 30   |  |  |  |  |  |  | 1 | 21 |
| 72-75   | 54 | 32,5 |  |  |  |  |  |  | 1 | 25 |
| 77-80   | 59 | 35   |  |  |  |  |  |  | 1 | 25 |
| 87-90   | 58 | 40   |  |  |  |  |  |  | 1 | 30 |
| 97-100  | 68 | 45   |  |  |  |  |  |  | 1 | 32 |
| 107-110 | 78 | 50   |  |  |  |  |  |  | 1 | 35 |
| 117-120 | 88 | 55   |  |  |  |  |  |  | 1 | 40 |

X lunghezza parete doccia\ shower wall length  
A spazio d'entrata\ entrance space  
P lunghezza porta\ door length

attenzione

warning

Il prezzo della L speciale va trovato nella tabella Misure speciali L in base alla L della parete doccia

Special price for L is to be found in Special sizes L as per L needed size

Misure speciali  
Special size

L min 60 cm  
L max 120 cm

supplementi

supplements

Profilo di compensazione 3 cm  
Extension profile 3 cm

Sigillante SPARTAN®  
Sealant SPARTAN®

35A030200 €

36B010010 €

Approfondimenti  
Insights



|   |     |
|---|-----|
| Indice<br>Index                           | 3   |
| Legenda simboli<br>Icons legend           | 11  |
| Profili - Vetri<br>Profiles - Glasses     | 21  |
| Ricambi<br>Spare parts                    | 406 |
| Profili speciali<br>Special profiles      | 434 |
| Schede rilievo misure<br>Measurement form | 444 |

| 05                      | 11     | 12       | 16    | 24    | 25   | 26   | 27                 | 28          | 29           | 30       | 31         | 32 | 34 |
|-------------------------|--------|----------|-------|-------|------|------|--------------------|-------------|--------------|----------|------------|----|----|
| acrilico satin<br>flack | reflex | satinato | nigol | flute | wave | alon | fumè brown<br>fumè | trasparente | extrachiario | cincillà | stampato C |    |    |
| origin                  | abitat |          | vogue |       |      |      |                    |             |              |          |            |    |    |

59 Nero / 60 Bianco 27 Tcrom® / 21 Tinox® / 22 Tbronz® 61 Orosatinato / 62 Ororosa / 63 Cromonero / 64 Franciacorta / 65 Rame / 66 Brownie / Colori





Porta scorrevole installazione a tre lati  
 profilo Nero / vetro Trasparente  
 Piatto doccia ARTURO

Sliding door three sides installation  
 Nero profile / Transparent glass  
 Shower tray ARTURO

## OTTAVIO

Il vetro spessore 8 mm e i profili dal design essenziale e pulito, rendono questa serie concreta e armoniosa. Una serie per chi ama sentirsi protetto. Vetri incorniciati da profili a sezione rettangolare dall'aspetto moderno e accattivante. Lo studio attento delle varie componenti lo rendono esteticamente euritmico, ma anche solido e concreto. La maniglia dalla forma semplice e allungata ne sottolinea la linearità

The 8mm thick glass and the linear and clean profiles make this series an example of harmony and balance. A series for those who wish to feel protected. The glasses are framed by profiles with a rectangular section, with a modern and captivating look. The attentive studies of all the components of this shower wall make it eurythmic, aesthetically balanced, but also sturdy and solid. The handle has a simple shape and its length enhances the linearity of this elongated shape

**01** giunto con angolo di fissaggio a 45° | **02** fermo dell'anta con fine corsa e tappi di chiusura profili | **03** profilo di tenuta acqua | **04** sistema di sgancio anta facilitato | **05** maniglia esterna/pomoli interni per OT-ASC | **06** doppia maniglia esterna/interna, interasse 32cm |

**01** connection with 45° fixing angle | **02** door bumper with endblock and profile caps | **03** water sealing profile | **04** easy door release system | **05** external handle/internal knobs for OT-ASC | **06** double external/internal handle, interaxe 32cm |



**01**



**02**



**03**



**04**



**05**

**06**



### CARATTERISTICHE FEATURES

- H cm 200** ALTEZZA PARETI DOCCIA  
SHOWER DOOR HEIGHT
- 8 mm** SPESSORE LASTRA  
GLASS DEPTH
- NON REVERSIBILE**  
NON-REVERSIBLE

### INFO TECNICHE TECHNICAL INFORMATION

- REGOLAZIONE FUORI SQUADRO**  
OFF-SQUARE REGULATION
- EST cm** ESTENSIBILITÀ 2/4  
EXSTENSIBILITY 2/4
- SGANCIO RAPIDO**  
QUICK-RELEASE
- CHIUSURA MAGNETICA**  
MAGNETIC CLOSURE
- PROFILO MAGNETICO**  
MAGNETIC PROFILE
- PROFILO TENUTA ACQUA**  
SEAL WATER PROFILE
- MANIGLIE ESTERNA/INTERNA**  
EXTERNAL/INTERNAL HANDLES
- TRATTAMENTO NEVERDROP®**  
NEVERDROP® TREATMENT
- MISURE SPECIALI**  
SPECIAL SIZES

### Finiture profili

#### ORIGIN

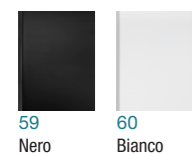

### Profiles finishing

#### ABITAT

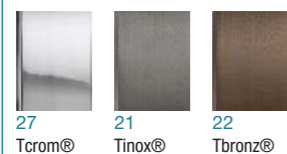

#### VOGUE

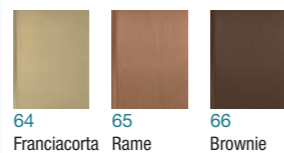
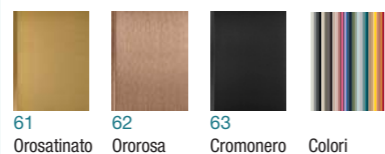

### Vetri

### Glasses

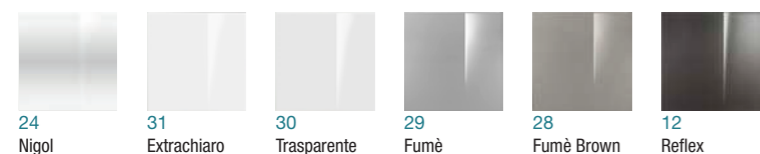

### in nicchia

OT-PSC

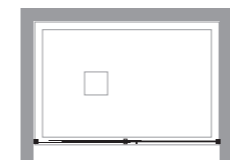

OT-PSC2

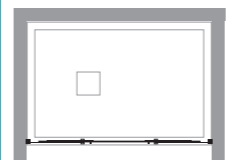

OT-PBA

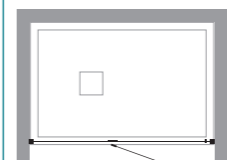

### niche

### ad angolo

OT-PSCF+OT-F

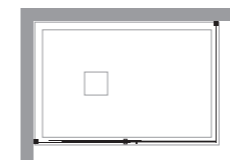

OT-PSC+OT-FA

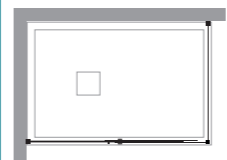

### corner

OT-PSC2 + OT-FA

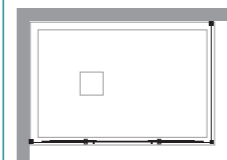

2xOT-ASC

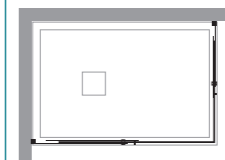

OT-PBAF+OT-FB

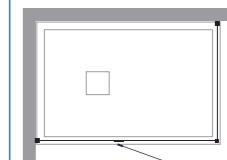

### a tre lati

OT-PSCF+OT-F+OT-FA

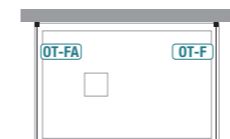

OT-PSC+2xOT-FA

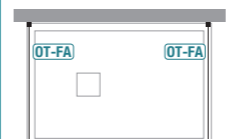

### three sides

OT-PSC2+2xOT-FA

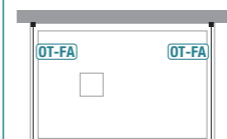

2xOT-ASC+OT-FA

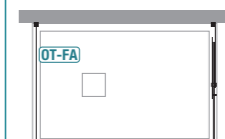

### profili

### profiles

per/for **OT: PSC-PSCF-PSC2-ASC-F-FA-PBA-PBAF-FB**

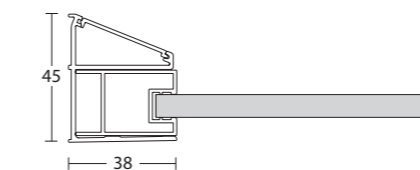

profilo a muro 1501 + schienale 1502

wall profile 1501 + vertical profile 1502

per/for **OT-PBA**

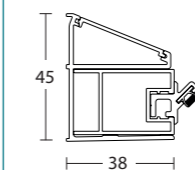

profilo a muro 1501 + chiusura con magnete 1502/1570

wall profile 1501 + magnetic closing 1502/1570

per/for **OT-PSC**

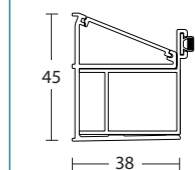

profilo a muro 1501 + schienale 1504

wall profile 1501 + vertical profile 1504

### importante

### important

ordini per pareti doccia speciali senza relativo disegno **NON** vengono prodotti

orders for special shower walls without related design are **NOT** produced

per installazioni particolari richiedere fattibilità. Alcune configurazioni necessitano di elementi aggiuntivi

contact TDA technical office for particular installation. More elements could be needed







SX  
LH



DX  
RH



H cm  
200





8 mm





REV

incluso      included





















disponibile      available



installazioni

ad angolo      corner  
OT-PSCF+OT-F



installations

a tre lati      three sides  
OT-PSCF+OT-F+OT-FA

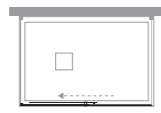

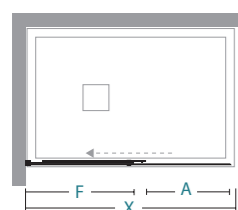

informazioni



apertura scorrevole  
sliding door

informations

|         | X  | A  | F |  |  |  |  |  |  |  |  |
|---------|----|----|---|--|--|--|--|--|--|---|---|
| 98-100  | 41 | 47 |   |  |  |  |  |  |  | 2   | 49  |
| 118-120 | 51 | 57 |   |  |  |  |  |  |  | 2   | 59  |
| 128-130 | 56 | 62 |   |  |  |  |  |  |  | 2   | 61  |
| 138-140 | 61 | 67 |   |  |  |  |  |  |  | 2   | 66  |
| 148-150 | 66 | 72 |   |  |  |  |  |  |  | 2   | 70  |
| 158-160 | 71 | 77 |   |  |  |  |  |  |  | 2   | 74  |

X lunghezza parete doccia\ shower wall length  
A spazio d'entrata\ entrance space  
F lunghezza lato fisso\ fixed side length

Misure standard

| Codice SX<br>LH Code | Codice DX<br>RH Code | estensibilità<br>extension | Finiture profili<br>Profiles finishing | 30 | 29 | 28 | 31 | 12 |
|----------------------|----------------------|----------------------------|--|----|----|----|----|----|
| 04P210100            | 04P200100            | 98-100                     | origin<br>abitat<br>vogue              |    |    |    |    |    |
| 04P210120            | 04P200120            | 118-120                    | origin<br>abitat<br>vogue              |    |    |    |    |    |
| 04P210130            | 04P200130            | 128-130                    | origin<br>abitat<br>vogue              |    |    |    |    |    |
| 04P210140            | 04P200140            | 138-140                    | origin<br>abitat<br>vogue              |    |    |    |    |    |
| 04P210150            | 04P200150            | 148-150                    | origin<br>abitat<br>vogue              |    |    |    |    |    |
| 04P210160            | 04P200160            | 158-160                    | origin<br>abitat<br>vogue              |    |    |    |    |    |

Misure speciali L / H

| Codice SX<br>LH Code | Codice DX<br>RH Code | su misura<br>bespoke | Finiture profili<br>Profiles finishing | 30 | 29 | 28 | 24 | 31 | 12 |
|----------------------|----------------------|----------------------|--|----|----|----|----|----|----|
| 04P219001            | 04P209001            | 60 < L < 100         | origin<br>abitat<br>vogue              |    |    |    |    |    |    |
| 04P219001            | 04P209001            | 101 < L < 120        | origin<br>abitat<br>vogue              |    |    |    |    |    |    |
| 04P219001            | 04P209001            | 121 < L < 140        | origin<br>abitat<br>vogue              |    |    |    |    |    |    |
| 04P219001            | 04P209001            | 141 < L < 160        | origin<br>abitat<br>vogue              |    |    |    |    |    |    |
| 04P219001            | 04P209001            | 161 < L < 180        | origin<br>abitat<br>vogue              |    |    |    |    |    |    |

attenzione

Il prezzo della H speciale va trovato nella tabella Misure speciali L / H in base alla L della parete doccia

Special price for H is to be found in Special sizes L / H as per L needed size

warning

Misure speciali  
Special size

|   |     |        |
|---|-----|--------|
| H | max | 210 cm |
| L | min | 60 cm  |
| L | max | 180 cm |

Disponibilità  
Availability

 STOCK Tcrom®

supplementi

Sigillante SPARTAN®  
Sealant SPARTAN®

supplements

€

36B010010

|                |       |        |          |       |       |      |      |            |      |             |              |          |            |
|----------------|-------|--------|----------|-------|-------|------|------|------------|------|-------------|--------------|----------|------------|
| 05             | 11    | 12     | 16       | 24    | 25    | 26   | 27   | 28         | 29   | 30          | 31           | 32       | 34         |
| acrilico satin | flack | reflex | satinato | nigol | flute | wave | alon | fumè brown | fumè | trasparente | extrachiario | cincillà | stampato C |

|                     |                                    |  |
|---------------------|------------------------------------|--|
| origin              | abitat                             | vogue  |
| 59 Nero / 60 Bianco | 27 Tcrom® / 21 Tinox® / 22 Tbronz® | 61 Orosatinato / 62 Ororosa / 63 Cromonero / 64 Franciacorta / 65 Rame / 66 Brownie / Colori |

Approfondimenti  
Insights



|   |     |
|---|-----|
| Indice<br>Index                           | 3   |
| Legenda simboli<br>Icons legend           | 11  |
| Profili - Vetri<br>Profiles - Glasses     | 21  |
| Ricambi<br>Spare parts                    | 406 |
| Profili speciali<br>Special profiles      | 434 |
| Schede rilievo misure<br>Measurement form | 444 |







SX  
LH





DX  
RH

incluso

included

disponibile



available

installazioni

ad angolo corner  
OT-F+OT-PSCF



informazioni

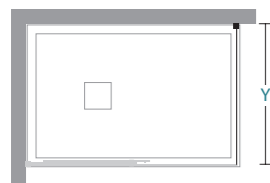

Y lunghezza parete doccia\ shower wall length

installations

informations

| Y      |  |  |  |  |  |  |  |   |    |
|--------|--|--|--|--|--|--|--|---|----|
| 68-70  |  |  |  |  |  |  |  | 1 | 34 |
| 73-75  |  |  |  |  |  |  |  | 1 | 36 |
| 78-80  |  |  |  |  |  |  |  | 1 | 39 |
| 83-85  |  |  |  |  |  |  |  | 1 | 39 |
| 88-90  |  |  |  |  |  |  |  | 1 | 41 |
| 98-100 |  |  |  |  |  |  |  | 1 | 46 |

| Misure standard      |                      |                            | Standard sizes                         |    |    |    |    |    |
|----------------------|----------------------|----------------------------|--|----|----|----|----|----|
| Codice SX<br>LH Code | Codice DX<br>RH Code | estensibilità<br>extension | Finiture profili<br>Profiles finishing | 30 | 29 | 28 | 31 | 12 |
| 04F110070            | 04F100070            | 68-70                      | origin<br>abitat<br>vogue              |    |    |    |    |    |
| 04F110075            | 04F100075            | 73-75                      | origin<br>abitat<br>vogue              |    |    |    |    |    |
| 04F110080            | 04F100080            | 78-80                      | origin<br>abitat<br>vogue              |    |    |    |    |    |
| 04F110085            | 04F100085            | 83-85                      | origin<br>abitat<br>vogue              |    |    |    |    |    |
| 04F110090            | 04F100090            | 88-90                      | origin<br>abitat<br>vogue              |    |    |    |    |    |
| 04F110100            | 04F100100            | 98-100                     | origin<br>abitat<br>vogue              |    |    |    |    |    |

| Misure speciali L / H |                      |                      | Special sizes L / H                    |    |    |    |    |    |    |
|-----------------------|----------------------|----------------------|--|----|----|----|----|----|----|
| Codice SX<br>LH Code  | Codice DX<br>RH Code | su misura<br>bespoke | Finiture profili<br>Profiles finishing | 30 | 29 | 28 | 24 | 31 | 12 |
| 04F119001             | 04F109001            | 19 < L < 40          | origin<br>abitat<br>vogue              |    |    |    |    |    |    |
| 04F119001             | 04F109001            | 41 < L < 60          | origin<br>abitat<br>vogue              |    |    |    |    |    |    |
| 04F119001             | 04F109001            | 61 < L < 80          | origin<br>abitat<br>vogue              |    |    |    |    |    |    |
| 04F119001             | 04F109001            | 81 < L < 100         | origin<br>abitat<br>vogue              |    |    |    |    |    |    |
| 04F119001             | 04F109001            | 101 < L < 120        | origin<br>abitat<br>vogue              |    |    |    |    |    |    |

attenzione

Il prezzo della H speciale va trovato nella tabella Misure speciali L / H in base alla L della parete doccia

Special price for H is to be found in Special sizes L / H as per L needed size

warning

Specificare se installato a pavimento

Specify any floor installation

| Misure speciali<br>Special size             | Disponibilità<br>Availability |        |
|---|-------------------------------|--------|
| H max 210 cm<br>L min 19 cm<br>L max 120 cm | STOCK                         | Tcrom® |

supplementi

Sigillante SPARTAN®  
Sealant SPARTAN®

36B010010

| 05             | 11    | 12     | 16       | 24    | 25    | 26   | 27   | 28         | 29   | 30          | 31           | 32       | 34         |
|----------------|-------|--------|----------|-------|-------|------|------|------------|------|-------------|--------------|----------|------------|
| acrilico satin | flack | reflex | satinato | nigol | flute | wave | alon | fumè brown | fumè | trasparente | extrachiario | cincillà | stampato C |

| origin              | abitat                             | vogue  |
|---------------------|------------------------------------|--|
| 59 Nero / 60 Bianco | 27 Tcrom® / 21 Tinox® / 22 Tbronz® | 61 Orosatinato / 62 Ororosa / 63 Cromonero / 64 Franciacorta / 65 Rame / 66 Brownie / Colori |

Approfondimenti  
Insights



|   |     |
|---|-----|
| Indice<br>Index                           | 3   |
| Legenda simboli<br>Icons legend           | 11  |
| Profili - Vetri<br>Profiles - Glasses     | 21  |
| Ricambi<br>Spare parts                    | 406 |
| Profili speciali<br>Special profiles      | 434 |
| Schede rilievo misure<br>Measurement form | 444 |







SX  
LH



DX  
RH

incluso





included





disponibile

available



installazioni

in nicchia niche  
OT-PSC



installations

ad angolo corner  
OT-PSC+OT-FA



a tre lati three sides  
OT-PSC+OT-FA+OT-FA

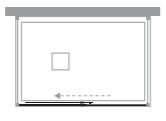

informazioni

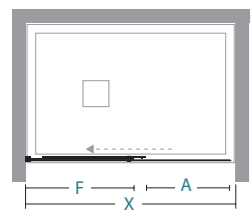

apertura scorrevole  
sliding door

informations

|         | X    | A    | F |  |  |  |  |  |  |   |    |
|---------|------|------|---|--|--|--|--|--|--|---|----|
| 96-100  | 39,5 | 45,5 |   |  |  |  |  |  |  | 2 | 49 |
| 106-110 | 44,5 | 50,5 |   |  |  |  |  |  |  | 2 | 56 |
| 116-120 | 49,5 | 55,5 |   |  |  |  |  |  |  | 2 | 59 |
| 126-130 | 54,5 | 60,5 |   |  |  |  |  |  |  | 2 | 63 |
| 136-140 | 59,5 | 65,5 |   |  |  |  |  |  |  | 2 | 66 |
| 146-150 | 64,5 | 70,5 |   |  |  |  |  |  |  | 2 | 74 |
| 156-160 | 69,5 | 75,5 |   |  |  |  |  |  |  | 2 | 75 |
| 166-170 | 69,5 | 85,5 |   |  |  |  |  |  |  | 2 | 79 |
| 176-180 | 69,5 | 95,5 |   |  |  |  |  |  |  | 2 | 84 |

X lunghezza parete doccia\ shower wall length  
A spazio d'entrata\ entrance space  
F lunghezza lato fisso\ fixed side length

Misure standard

| Codice SX<br>LH Code | Codice DX<br>RH Code | estensibilità<br>extension | Finiture profili<br>Profiles finishing | 30 | 29 | 28 | 31 | 12 |
|----------------------|----------------------|----------------------------|--|----|----|----|----|----|
| 04P110100            | 04P100100            | 96-100                     | origin<br>abitat<br>vogue              |    |    |    |    |    |
| 04P110110            | 04P100110            | 106-110                    | origin<br>abitat<br>vogue              |    |    |    |    |    |
| 04P110120            | 04P100120            | 116-120                    | origin<br>abitat<br>vogue              |    |    |    |    |    |
| 04P110130            | 04P100130            | 126-130                    | origin<br>abitat<br>vogue              |    |    |    |    |    |
| 04P110140            | 04P100140            | 136-140                    | origin<br>abitat<br>vogue              |    |    |    |    |    |
| 04P110150            | 04P100150            | 146-150                    | origin<br>abitat<br>vogue              |    |    |    |    |    |
| 04P110160            | 04P100160            | 156-160                    | origin<br>abitat<br>vogue              |    |    |    |    |    |
| 04P110170            | 04P100170            | 166-170                    | origin<br>abitat<br>vogue              |    |    |    |    |    |
| 04P110180            | 04P100180            | 176-180                    | origin<br>abitat<br>vogue              |    |    |    |    |    |

Misure speciali L / H

| Codice SX<br>LH Code | Codice DX<br>RH Code | su misura<br>bespoke | Finiture profili<br>Profiles finishing | 30 | 29 | 28 | 24 | 31 | 12 |
|----------------------|----------------------|----------------------|--|----|----|----|----|----|----|
| 04P119001            | 04P109001            | 80 < L < 100         | origin<br>abitat<br>vogue              |    |    |    |    |    |    |
| 04P119001            | 04P109001            | 101 < L < 120        | origin<br>abitat<br>vogue              |    |    |    |    |    |    |
| 04P119001            | 04P109001            | 121 < L < 140        | origin<br>abitat<br>vogue              |    |    |    |    |    |    |
| 04P119001            | 04P109001            | 141 < L < 160        | origin<br>abitat<br>vogue              |    |    |    |    |    |    |
| 04P119001            | 04P109001            | 161 < L < 180        | origin<br>abitat<br>vogue              |    |    |    |    |    |    |

attenzione

Il prezzo della H speciale va trovato nella tabella Misure speciali L / H in base alla L della parete doccia

Special price for H is to be found in Special sizes L / H as per L needed size

warning

Misure speciali  
Special size

|   |     |        |
|---|-----|--------|
| H | max | 210 cm |
| L | min | 80 cm  |
| L | max | 180 cm |

supplementi

Sigillante SPARTAN®  
Sealant SPARTAN®

36B010010

| 05             | 11    | 12     | 16       | 24    | 25    | 26   | 27   | 28         | 29   | 30          | 31           | 32       | 34         |
|----------------|-------|--------|----------|-------|-------|------|------|------------|------|-------------|--------------|----------|------------|
| acrilico satin | flack | reflex | satinato | nigol | flute | wave | alon | fumè brown | fumè | trasparente | extrachiario | cincillà | stampato C |

| origin              | abitat                             | vogue  |
|---------------------|------------------------------------|--|
| 59 Nero / 60 Bianco | 27 Tcrom® / 21 Tinox® / 22 Tbronz® | 61 Orosatinato / 62 Ororosa / 63 Cromonero / 64 Franciacorta / 65 Rame / 66 Brownie / Colori |

Approfondimenti  
Insights



|   |     |
|---|-----|
| Indice<br>Index                           | 3   |
| Legenda simboli<br>Icons legend           | 11  |
| Profili - Vetri<br>Profiles - Glasses     | 21  |
| Ricambi<br>Spare parts                    | 406 |
| Profili speciali<br>Special profiles      | 434 |
| Schede rilievo misure<br>Measurement form | 444 |

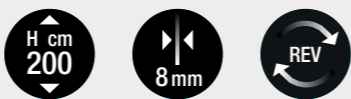
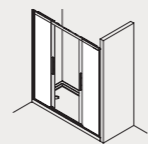

incluso included

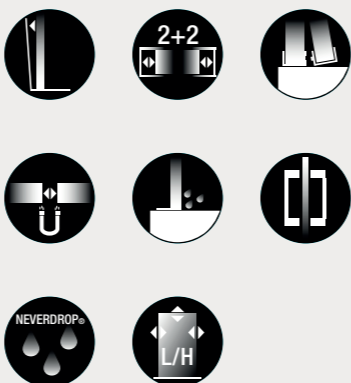

disponibile available



installazioni

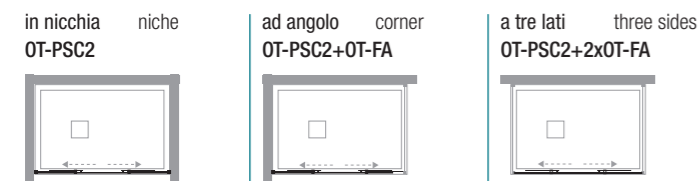

informazioni

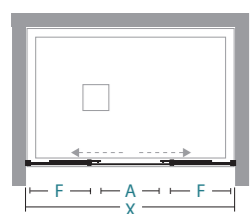

informations

apertura scorrevole  
sliding door

|         | X  | A    | F |  |  |  |  |  |   |    |
|---------|----|------|---|--|--|--|--|--|---|----|
| 136-140 | 55 | 33,5 |   |  |  |  |  |  | 2 | 69 |
| 146-150 | 60 | 36   |   |  |  |  |  |  | 2 | 75 |
| 156-160 | 65 | 38,5 |   |  |  |  |  |  | 2 | 78 |
| 166-170 | 70 | 41   |   |  |  |  |  |  | 2 | 82 |
| 176-180 | 75 | 43,5 |   |  |  |  |  |  | 2 | 87 |

X lunghezza parete doccia\ shower wall length  
A spazio d'entrata\ entrance space  
F1 / F2 lunghezza lato fisso\ fixed side length

Misure standard Standard sizes

| Codice Code | estensibilità extension | Finiture profili Profiles finishing | 30 | 29 | 28 | 31 | 12 |
|-------------|-------------------------|-------------------------------------|----|----|----|----|----|
| 04P120140   | 136-140                 | origin<br>abitat<br>vogue           |    |    |    |    |    |
| 04P120150   | 146-150                 | origin<br>abitat<br>vogue           |    |    |    |    |    |
| 04P120160   | 156-160                 | origin<br>abitat<br>vogue           |    |    |    |    |    |
| 04P120170   | 166-170                 | origin<br>abitat<br>vogue           |    |    |    |    |    |
| 04P120180   | 176-180                 | origin<br>abitat<br>vogue           |    |    |    |    |    |

Misure speciali L / H Special sizes L / H

| Codice Code | su misura bespoke | Finiture profili Profiles finishing | 30 | 29 | 28 | 24 | 31 | 12 |
|-------------|-------------------|-------------------------------------|----|----|----|----|----|----|
| 04P129001   | 120 < L < 140     | origin<br>abitat<br>vogue           |    |    |    |    |    |    |
| 04P129001   | 141 < L < 160     | origin<br>abitat<br>vogue           |    |    |    |    |    |    |
| 04P129001   | 161 < L < 180     | origin<br>abitat<br>vogue           |    |    |    |    |    |    |

attenzione

Il prezzo della H speciale va trovato nella tabella Misure speciali L / H in base alla L della parete doccia

Special price for H is to be found in Special sizes L / H as per L needed size

warning

Misure speciali  
Special size

|   |     |        |
|---|-----|--------|
| H | max | 210 cm |
| L | min | 120 cm |
| L | max | 180 cm |

supplementi

Sigillante SPARTAN®  
Sealant SPARTAN®

€

36B010010

|                |       |        |          |       |       |      |      |            |      |             |              |          |            |
|----------------|-------|--------|----------|-------|-------|------|------|------------|------|-------------|--------------|----------|------------|
| 05             | 11    | 12     | 16       | 24    | 25    | 26   | 27   | 28         | 29   | 30          | 31           | 32       | 34         |
| acrilico satin | flack | reflex | satinato | nigol | flute | wave | alon | fumè brown | fumè | trasparente | extrachiario | cincillà | stampato C |

|                     |                                    |  |
|---------------------|------------------------------------|--|
| origin              | abitat                             | vogue  |
| 59 Nero / 60 Bianco | 27 Tcrom® / 21 Tinox® / 22 Tbronz® | 61 Orosatinato / 62 Ororosa / 63 Cromonero / 64 Franciacorta / 65 Rame / 66 Brownie / Colori |

Approfondimenti  
Insights



|  |     |
|--|-----|
| Indice Index                           | 3   |
| Legenda simboli Icons legend           | 11  |
| Profili - Vetri Profiles - Glasses     | 21  |
| Ricambi Spare parts                    | 406 |
| Profili speciali Special profiles      | 434 |
| Schede rilievo misure Measurement form | 444 |

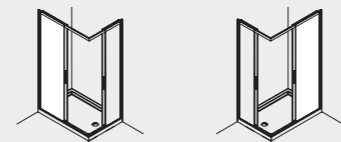

SX LH      DX RH



incluso      included

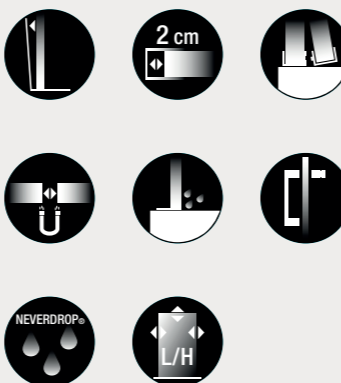

disponibile      available



installazioni      installations

ad angolo      corner  
OT-ASC+OT-ASC



a tre lati      three sides  
2xOT-ASC+OT-FA

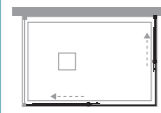

informazioni      informations

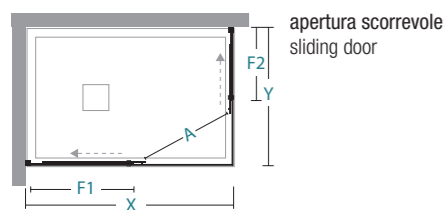

X / Y      lunghezza parete doccia \ shower wall length  
A      spazio d'entrata \ entrance space  
F1 / F2      lunghezza lato fisso \ fixed side length

| X/Y     | 68-70  | 73-75  | 78-80  | 88-90  | 98-100 | 118-120 | F1/F2 |   |    |
|---------|--------|--------|--------|--------|--------|---------|-------|---|----|
| 68-70   | A=36,5 |        |        |        |        |         | 32    | 1 | 35 |
| 73-75   | A=38,5 | A=40   |        |        |        |         | 34,5  | 1 | 37 |
| 78-80   | A=40   | A=42   | A=43,5 |        |        |         | 37    | 2 | 42 |
| 88-90   | A=44   | A=45,5 | A=47   | A=50,5 |        |         | 41    | 2 | 44 |
| 98-100  | A=47   | A=49   | A=50   | A=53,5 | A=56   |         | 47    | 2 | 49 |
| 118-120 | A=56   | A=57   | A=58,5 | A=61   | A=63,5 | A=70    | 57    | 2 | 57 |

Misure standard      Standard sizes

| Codice SX<br>LH Code | Codice DX<br>RH Code | estensibilità<br>extension | Finiture profili<br>Profiles finishing | 30 | 29 | 28 | 31 | 12 |
|----------------------|----------------------|----------------------------|--|----|----|----|----|----|
| 04A110070            | 04A100070            | 68-70                      | origin<br>abitat<br>vogue              |    |    |    |    |    |
| 04A110075            | 04A100075            | 73-75                      | origin<br>abitat<br>vogue              |    |    |    |    |    |
| 04A110080            | 04A100080            | 78-80                      | origin<br>abitat<br>vogue              |    |    |    |    |    |
| 04A110090            | 04A100090            | 88-90                      | origin<br>abitat<br>vogue              |    |    |    |    |    |
| 04A110100            | 04A100100            | 98-100                     | origin<br>abitat<br>vogue              |    |    |    |    |    |
| 04A110120            | 04A100120            | 118-120                    | origin<br>abitat<br>vogue              |    |    |    |    |    |

Misure speciali L / H      Special sizes L / H

| Codice SX<br>LH Code | Codice DX<br>RH Code | su misura<br>bespoke | Finiture profili<br>Profiles finishing | 30 | 29 | 28 | 24 | 31 | 12 |
|----------------------|----------------------|----------------------|--|----|----|----|----|----|----|
| 04A119001            | 04A109001            | 60 < L < 80          | origin<br>abitat<br>vogue              |    |    |    |    |    |    |
| 04A119001            | 04A109001            | 81 < L < 100         | origin<br>abitat<br>vogue              |    |    |    |    |    |    |
| 04A119001            | 04A109001            | 101 < L < 120        | origin<br>abitat<br>vogue              |    |    |    |    |    |    |
| 04A119001            | 04A109001            | 121 < L < 140        | origin<br>abitat<br>vogue              |    |    |    |    |    |    |

attenzione      warning

Il prezzo della H speciale va trovato nella tabella Misure speciali L / H in base alla L della parete doccia

Special price for H is to be found in Special sizes L / H as per L needed size

Il prezzo è inteso per lato

Prices are to be intended for one side

Misure speciali  
Special size

|   |     |        |
|---|-----|--------|
| H | max | 210 cm |
| L | min | 60 cm  |
| L | max | 140 cm |

supplementi      supplements

Sigillante SPARTAN®  
Sealant SPARTAN®

€

36B010010

|                |       |        |          |       |       |      |      |            |      |             |              |          |            |
|----------------|-------|--------|----------|-------|-------|------|------|------------|------|-------------|--------------|----------|------------|
| 05             | 11    | 12     | 16       | 24    | 25    | 26   | 27   | 28         | 29   | 30          | 31           | 32       | 34         |
| acrilico satin | flack | reflex | satinato | nigol | flute | wave | alon | fumè brown | fumè | trasparente | extrachiario | cincillà | stampato C |

|                     |                                    |  |
|---------------------|------------------------------------|--|
| origin              | abitat                             | vogue  |
| 59 Nero / 60 Bianco | 27 Tcrom® / 21 Tinox® / 22 Tbronz® | 61 Orosatinato / 62 Ororosa / 63 Cromonero / 64 Franciacorta / 65 Rame / 66 Brownie / Colori |

Approfondimenti  
Insights



|   |     |
|---|-----|
| Indice<br>Index                           | 3   |
| Legenda simboli<br>Icons legend           | 11  |
| Profili - Vetri<br>Profiles - Glasses     | 21  |
| Ricambi<br>Spare parts                    | 406 |
| Profili speciali<br>Special profiles      | 434 |
| Schede rilievo misure<br>Measurement form | 444 |



incluso

included

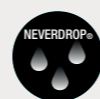

disponibile

available



#### installazioni

#### installations

ad angolo corner



a tre lati three sides



a tre lati three sides

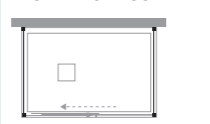

a tre lati three sides

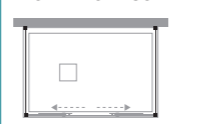

a tre lati three sides



#### informazioni

#### informations

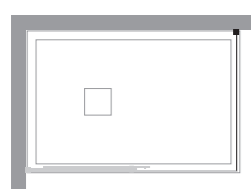

| Y      |  |  |  |  |   |    |
|--------|--|--|--|--|---|----|
| 68-70  |  |  |  |  | 1 | 35 |
| 73-75  |  |  |  |  | 1 | 37 |
| 78-80  |  |  |  |  | 1 | 38 |
| 83-85  |  |  |  |  | 1 | 39 |
| 88-90  |  |  |  |  | 1 | 41 |
| 98-100 |  |  |  |  | 1 | 45 |

Y lunghezza parete doccia \ shower wall length

#### Misure standard

#### Standard sizes

| Codice Code | estensibilità extension | Finiture profili Profiles finishing | 30 | 29 | 28 | 31 | 12 |
|-------------|-------------------------|-------------------------------------|----|----|----|----|----|
| 04F120070   | 68-70                   | origin<br>abitat<br>vogue           |    |    |    |    |    |
| 04F120075   | 73-75                   | origin<br>abitat<br>vogue           |    |    |    |    |    |
| 04F120080   | 78-80                   | origin<br>abitat<br>vogue           |    |    |    |    |    |
| 04F120085   | 83-85                   | origin<br>abitat<br>vogue           |    |    |    |    |    |
| 04F120090   | 88-90                   | origin<br>abitat<br>vogue           |    |    |    |    |    |
| 04F120100   | 98-100                  | origin<br>abitat<br>vogue           |    |    |    |    |    |

#### Misure speciali L / H

#### Special sizes L / H

| Codice Code | su misura bespoke | Finiture profili Profiles finishing | 30 | 29 | 28 | 24 | 31 | 12 |
|-------------|-------------------|-------------------------------------|----|----|----|----|----|----|
| 04F129001   | 20 < L < 40       | origin<br>abitat<br>vogue           |    |    |    |    |    |    |
| 04F129001   | 41 < L < 60       | origin<br>abitat<br>vogue           |    |    |    |    |    |    |
| 04F129001   | 61 < L < 80       | origin<br>abitat<br>vogue           |    |    |    |    |    |    |
| 04F129001   | 81 < L < 100      | origin<br>abitat<br>vogue           |    |    |    |    |    |    |
| 04F129001   | 101 < L < 120     | origin<br>abitat<br>vogue           |    |    |    |    |    |    |

#### attenzione

#### warning

Il prezzo della H speciale va trovato nella tabella Misure speciali L / H in base alla L della parete doccia

Special price for H is to be found in Special sizes L / H as per L needed size

Specificare se installato a pavimento

Specify any floor installation

#### Misure speciali

| Special size | H max  | L min | L max  |
|--------------|--------|-------|--------|
|              | 210 cm | 20 cm | 120 cm |

#### supplementi

#### supplements

Sigillante SPARTAN®  
Sealant SPARTAN®

36B010010

| 05             | 11    | 12     | 16       | 24    | 25    | 26   | 27   | 28         | 29   | 30          | 31          | 32       | 34         |
|----------------|-------|--------|----------|-------|-------|------|------|------------|------|-------------|-------------|----------|------------|
| acrilico satin | flack | reflex | satinato | nigol | flute | wave | alon | fumè brown | fumè | trasparente | extrachiara | cincillà | stampato C |

| origin              | abitat                             | vogue  |
|---------------------|------------------------------------|--|
| 59 Nero / 60 Bianco | 27 Tcrom® / 21 Tinox® / 22 Tbronz® | 61 Orosatinato / 62 Ororosa / 63 Cromonero / 64 Franciacorta / 65 Rame / 66 Brownie / Colori |

#### Approfondimenti

Insights



|  |     |
|--|-----|
| Indice Index                           | 3   |
| Legenda simboli Icons legend           | 11  |
| Profili - Vetri Profiles - Glasses     | 21  |
| Ricambi Spare parts                    | 406 |
| Profili speciali Special profiles      | 434 |
| Schede rilievo misure Measurement form | 444 |



SX  
LH

DX  
RH

incluso

included

disponibile

available

installazioni

in nicchia niche  
OT-PBA

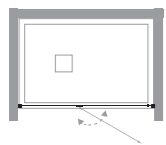

informazioni

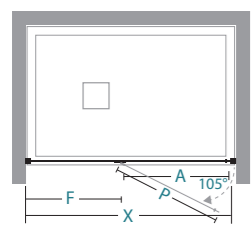

- X lunghezza parete doccia\ shower wall length
- A spazio d'entrata\ entrance space
- P lunghezza porta\ door length
- F lunghezza lato fisso\ fixed side length

installations

informations

apertura battente  
swing door

|         | X  | A    | F  | P |  |  |   |    |
|---------|----|------|----|---|--|--|---|----|
| 96-100  | 45 | 45,5 | 46 |   |  |  | 2 | 49 |
| 106-110 | 49 | 50,5 | 50 |   |  |  | 2 | 52 |
| 116-120 | 55 | 55,5 | 56 |   |  |  | 2 | 56 |
| 126-130 | 59 | 60,5 | 60 |   |  |  | 2 | 60 |
| 136-140 | 65 | 65,5 | 66 |   |  |  | 2 | 65 |
| 146-150 | 69 | 70,5 | 70 |   |  |  | 2 | 68 |
| 156-160 | 75 | 75,5 | 76 |   |  |  | 2 | 72 |
| 166-170 | 75 | 85,5 | 76 |   |  |  | 2 | 76 |
| 176-180 | 75 | 95,5 | 76 |   |  |  | 2 | 80 |

Misure standard

| Codice SX<br>LH Code | Codice DX<br>RH Code | estensibilità<br>extension | Finiture profili<br>Profiles finishing | 30 | 29 | 28 | 31 | 12 |
|----------------------|----------------------|----------------------------|--|----|----|----|----|----|
| 04P410100            | 04P400100            | 96-100                     | origin<br>abitat<br>vogue              |    |    |    |    |    |
| 04P410110            | 04P400110            | 106-110                    | origin<br>abitat<br>vogue              |    |    |    |    |    |
| 04P410120            | 04P400120            | 116-120                    | origin<br>abitat<br>vogue              |    |    |    |    |    |
| 04P410130            | 04P400130            | 126-130                    | origin<br>abitat<br>vogue              |    |    |    |    |    |
| 04P410140            | 04P400140            | 136-140                    | origin<br>abitat<br>vogue              |    |    |    |    |    |
| 04P410150            | 04P400150            | 146-150                    | origin<br>abitat<br>vogue              |    |    |    |    |    |
| 04P410160            | 04P400160            | 156-160                    | origin<br>abitat<br>vogue              |    |    |    |    |    |
| 04P410170            | 04P400170            | 166-170                    | origin<br>abitat<br>vogue              |    |    |    |    |    |
| 04P410180            | 04P400180            | 176-180                    | origin<br>abitat<br>vogue              |    |    |    |    |    |

Misure speciali L / H

| Codice SX<br>LH Code | Codice DX<br>RH Code | su misura<br>bespoke | Finiture profili<br>Profiles finishing | 30 | 29 | 28 | 24 | 31 | 12 |
|----------------------|----------------------|----------------------|--|----|----|----|----|----|----|
| 04P419001            | 04P409001            | 80 < L < 100         | origin<br>abitat<br>vogue              |    |    |    |    |    |    |
| 04P419001            | 04P409001            | 101 < L < 120        | origin<br>abitat<br>vogue              |    |    |    |    |    |    |
| 04P419001            | 04P409001            | 121 < L < 140        | origin<br>abitat<br>vogue              |    |    |    |    |    |    |
| 04P419001            | 04P409001            | 141 < L < 160        | origin<br>abitat<br>vogue              |    |    |    |    |    |    |
| 04P419001            | 04P409001            | 161 < L < 180        | origin<br>abitat<br>vogue              |    |    |    |    |    |    |

attenzione

Il prezzo della H speciale va trovato nella tabella Misure speciali L / H in base alla L della parete doccia

Special price for H is to be found in Special sizes L / H as per L needed size

Misure speciali  
Special size

|   |     |        |
|---|-----|--------|
| H | max | 210 cm |
| L | min | 80 cm  |
| L | max | 180 cm |

supplementi

Sigillante SPARTAN®  
Sealant SPARTAN®

36B010010

|                |       |        |          |       |       |      |      |            |      |             |              |          |            |
|----------------|-------|--------|----------|-------|-------|------|------|------------|------|-------------|--------------|----------|------------|
| 05             | 11    | 12     | 16       | 24    | 25    | 26   | 27   | 28         | 29   | 30          | 31           | 32       | 34         |
| acrilico satin | flack | reflex | satinato | nigol | flute | wave | alon | fumè brown | fumè | trasparente | extrachiario | cincillà | stampato C |

|                     |                                    |  |
|---------------------|------------------------------------|--|
| origin              | abitat                             | vogue  |
| 59 Nero / 60 Bianco | 27 Tcrom® / 21 Tinox® / 22 Tbronz® | 61 Orosatinato / 62 Ororosa / 63 Cromonero / 64 Franciacorta / 65 Rame / 66 Brownie / Colori |

Approfondimenti  
Insights



|   |     |
|---|-----|
| Indice<br>Index                           | 3   |
| Legenda simboli<br>Icons legend           | 11  |
| Profili - Vetri<br>Profiles - Glasses     | 21  |
| Ricambi<br>Spare parts                    | 406 |
| Profili speciali<br>Special profiles      | 434 |
| Schede rilievo misure<br>Measurement form | 444 |



SX  
LH

DX  
RH

H cm  
200

8 mm

REV

incluso      included

disponibile      available

installazioni

ad angolo      corner  
OT-PBAF+OT-FB

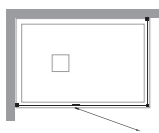

informazioni

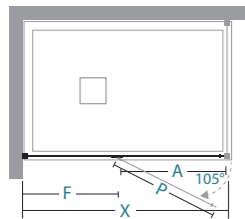

X lunghezza parete doccia\ shower wall length  
A spazio d'entrata\ entrance space  
P lunghezza porta\ door length  
F lunghezza lato fisso\ fixed side length

installations

informations

| X       | A  | F  | P  |  |  |  |  |   |    |
|---------|----|----|----|--|--|--|--|---|----|
| 98-100  | 47 | 47 | 50 |  |  |  |  | 2 | 48 |
| 118-120 | 57 | 57 | 60 |  |  |  |  | 2 | 56 |
| 128-130 | 62 | 62 | 65 |  |  |  |  | 2 | 60 |
| 138-140 | 67 | 67 | 70 |  |  |  |  | 2 | 64 |
| 148-150 | 72 | 72 | 75 |  |  |  |  | 2 | 67 |
| 158-160 | 72 | 82 | 75 |  |  |  |  | 2 | 71 |

Misure standard

| Codice SX<br>LH Code | Codice DX<br>RH Code | estensibilità<br>extension | Finiture profili<br>Profiles finishing | 30 | 29 | 28 | 31 | 12 |
|----------------------|----------------------|----------------------------|--|----|----|----|----|----|
| 04P470100            | 04P460100            | 98-100                     | origin<br>abitat<br>vogue              |    |    |    |    |    |
| 04P470120            | 04P460120            | 118-120                    | origin<br>abitat<br>vogue              |    |    |    |    |    |
| 04P470130            | 04P460130            | 128-130                    | origin<br>abitat<br>vogue              |    |    |    |    |    |
| 04P470140            | 04P460140            | 138-140                    | origin<br>abitat<br>vogue              |    |    |    |    |    |
| 04P470150            | 04P460150            | 148-150                    | origin<br>abitat<br>vogue              |    |    |    |    |    |
| 04P470160            | 04P460160            | 158-160                    | origin<br>abitat<br>vogue              |    |    |    |    |    |

Misure speciali L / H

| Codice SX<br>LH Code | Codice DX<br>RH Code | su misura<br>bespoke | Finiture profili<br>Profiles finishing | 30 | 29 | 28 | 24 | 31 | 12 |
|----------------------|----------------------|----------------------|--|----|----|----|----|----|----|
| 04P479001            | 04P469001            | 60 < L < 100         | origin<br>abitat<br>vogue              |    |    |    |    |    |    |
| 04P479001            | 04P469001            | 101 < L < 120        | origin<br>abitat<br>vogue              |    |    |    |    |    |    |
| 04P479001            | 04P469001            | 121 < L < 140        | origin<br>abitat<br>vogue              |    |    |    |    |    |    |
| 04P479001            | 04P469001            | 141 < L < 160        | origin<br>abitat<br>vogue              |    |    |    |    |    |    |
| 04P479001            | 04P469001            | 161 < L < 180        | origin<br>abitat<br>vogue              |    |    |    |    |    |    |

attenzione

Il prezzo della H speciale va trovato nella tabella Misure speciali L / H in base alla L della parete doccia

Special price for H is to be found in Special sizes L / H as per L needed size

warning

Misure speciali  
Special size

|   |     |        |
|---|-----|--------|
| H | max | 210 cm |
| L | min | 60 cm  |
| L | max | 180 cm |

supplementi

Sigillante SPARTAN®  
Sealant SPARTAN®

36B010010

|                |       |        |          |       |       |      |      |            |      |             |              |          |            |
|----------------|-------|--------|----------|-------|-------|------|------|------------|------|-------------|--------------|----------|------------|
| 05             | 11    | 12     | 16       | 24    | 25    | 26   | 27   | 28         | 29   | 30          | 31           | 32       | 34         |
| acrilico satin | flack | reflex | satinato | nigol | flute | wave | alon | fumè brown | fumè | trasparente | extrachiario | cincillà | stampato C |

|                     |                                    |  |
|---------------------|------------------------------------|--|
| origin              | abitat                             | vogue  |
| 59 Nero / 60 Bianco | 27 Tcrom® / 21 Tinox® / 22 Tbronz® | 61 Orosatinato / 62 Ororosa / 63 Cromonero / 64 Franciacorta / 65 Rame / 66 Brownie / Colori |

Approfondimenti  
Insights



|   |     |
|---|-----|
| Indice<br>Index                           | 3   |
| Legenda simboli<br>Icons legend           | 11  |
| Profili - Vetri<br>Profiles - Glasses     | 21  |
| Ricambi<br>Spare parts                    | 406 |
| Profili speciali<br>Special profiles      | 434 |
| Schede rilievo misure<br>Measurement form | 444 |



SX  
LH

DX  
RH

incluso

included

disponibile

available

installazioni

ad angolo corner  
OT-FB+OT-PBAF

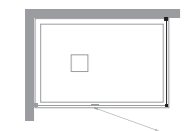

informazioni

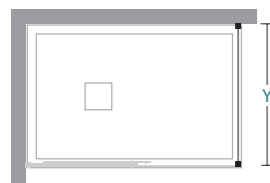

Y lunghezza parete doccia\ shower wall length

installations

informations

| Y      |  |  |  |  |  |  |  |   |    |
|--------|--|--|--|--|--|--|--|---|----|
| 68-70  |  |  |  |  |  |  |  | 1 | 32 |
| 73-75  |  |  |  |  |  |  |  | 1 | 35 |
| 78-80  |  |  |  |  |  |  |  | 1 | 38 |
| 83-85  |  |  |  |  |  |  |  | 1 | 41 |
| 88-90  |  |  |  |  |  |  |  | 1 | 44 |
| 98-100 |  |  |  |  |  |  |  | 1 | 46 |

Misure standard

| Codice SX<br>LH Code | Codice DX<br>RH Code | estensibilità<br>extension | Finiture profili<br>Profiles finishing | 30 | 29 | 28 | 31 | 12 |
|----------------------|----------------------|----------------------------|--|----|----|----|----|----|
| 04F210070            | 04F200070            | 68-70                      | origin<br>abitat<br>vogue              |    |    |    |    |    |
| 04F210075            | 04F200075            | 73-75                      | origin<br>abitat<br>vogue              |    |    |    |    |    |
| 04F210080            | 04F200080            | 78-80                      | origin<br>abitat<br>vogue              |    |    |    |    |    |
| 04F210085            | 04F200085            | 83-85                      | origin<br>abitat<br>vogue              |    |    |    |    |    |
| 04F210090            | 04F200090            | 88-90                      | origin<br>abitat<br>vogue              |    |    |    |    |    |
| 04F210100            | 04F200100            | 98-100                     | origin<br>abitat<br>vogue              |    |    |    |    |    |

Misure speciali L / H

| Codice SX<br>LH Code | Codice DX<br>RH Code | su misura<br>bespoke | Finiture profili<br>Profiles finishing | 30 | 29 | 28 | 24 | 31 | 12 |
|----------------------|----------------------|----------------------|--|----|----|----|----|----|----|
| 04F219001            | 04F209001            | 20 < L < 40          | origin<br>abitat<br>vogue              |    |    |    |    |    |    |
| 04F219001            | 04F209001            | 41 < L < 60          | origin<br>abitat<br>vogue              |    |    |    |    |    |    |
| 04F219001            | 04F209001            | 61 < L < 80          | origin<br>abitat<br>vogue              |    |    |    |    |    |    |
| 04F219001            | 04F209001            | 81 < L < 100         | origin<br>abitat<br>vogue              |    |    |    |    |    |    |
| 04F219001            | 04F209001            | 101 < L < 120        | origin<br>abitat<br>vogue              |    |    |    |    |    |    |

attenzione

Il prezzo della H speciale va trovato nella tabella Misure speciali L / H in base alla L della parete doccia

Special price for H is to be found in Special sizes L / H as per L needed size

warning

Specificare se installato a pavimento

Specify any floor installation

Misure speciali  
Special size

|   |     |        |
|---|-----|--------|
| H | max | 210 cm |
| L | min | 20 cm  |
| L | max | 120 cm |

supplementi

Sigillante SPARTAN®  
Sealant SPARTAN®

€

36B010010

|                |       |        |          |       |       |      |      |            |      |             |              |          |            |
|----------------|-------|--------|----------|-------|-------|------|------|------------|------|-------------|--------------|----------|------------|
| 05             | 11    | 12     | 16       | 24    | 25    | 26   | 27   | 28         | 29   | 30          | 31           | 32       | 34         |
| acrilico satin | flack | reflex | satinato | nigol | flute | wave | alon | fumè brown | fumè | trasparente | extrachiario | cincillà | stampato C |

|                     |                                    |  |
|---------------------|------------------------------------|--|
| origin              | abitat                             | vogue  |
| 59 Nero / 60 Bianco | 27 Tcrom® / 21 Tinox® / 22 Tbronz® | 61 Orosatinato / 62 Ororosa / 63 Cromonero / 64 Franciacorta / 65 Rame / 66 Brownie / Colori |

Approfondimenti  
Insights



|   |     |
|---|-----|
| Indice<br>Index                           | 3   |
| Legenda simboli<br>Icons legend           | 11  |
| Profili - Vetri<br>Profiles - Glasses     | 21  |
| Ricambi<br>Spare parts                    | 406 |
| Profili speciali<br>Special profiles      | 434 |
| Schede rilievo misure<br>Measurement form | 444 |



Porta scorrevole installazione ad angolo  
 profilo Soft Golden / vetro Trasparente  
 Piatto doccia AMBROGIO

Sliding door corner installation  
 Soft Golden profile / Transparent glass  
 Shower tray AMBROGIO

## DADO MAXI

Porte scorrevoli rigorose evidenziate dallo spessore dei profili. Lo sgancio rapido magnetico con sistema antipánico e il profilo magnetico di chiusura in finitura esaltano la contemporaneità della serie. Geometria ed eleganza caratterizzano la sua anatomia, la maniglia segue le linee scientifiche della parete doccia in misure perfettamente proporzionali. La serie si declina in diverse tipologie ognuna con accorgimenti attenti e precisi per garantire la massima versatilità di installazione

Sliding doors with a rigorous look, enhanced by the thickness of the profiles. The quick magnetic panic release system with matching finish, underline the contemporaneity of this series. A geometric elegance is the main feature of its anatomy, with the handle following the scientific lines of this perfectly balanced and harmonious shower wall. The series comes in many different styles, each with its own careful and precise adjustments to ensure maximum installation versatility



01



02



03



04



05

01 doppia maniglia esterna / interna interasse 32 cm | 02 sblocco magnetico antipánico per ante modello DM-PSM | 03 fermo centrale per modello apertura saloon | 04 cerniera con apertura a 90° | 05 profilo a due vie |

01 double handle external / internal, interaxe 32 cm | 02 safety magnetic unlock system | 03 central stop for saloon doors | 04 hinge with 90° opening | 05 two-way profile |

# Dado Maxi

Telaio - apertura scorrevole / battente / soffietto  
Frame panel - sliding / hinged / folding door



## CARATTERISTICHE FEATURES

- H cm 200** ALTEZZA PARETI DOCCIA  
SHOWER DOOR HEIGHT
- 6 mm** SPESSORE LASTRA  
GLASS DEPTH
- REV** REVERSIBILE  
REVERSIBLE

## INFO TECNICHE TECHNICAL INFORMATION

- REGOLAZIONE FUORI SQUADRO**  
OFF-SQUARE REGULATION
- EST cm** ESTENSIBILITÀ 3/6  
EXSTENSIBILITY 3/6
- SGANCIO RAPIDO**  
QUICK-RELEASE
- PROFILO MAGNETICO**  
MAGNETIC PROFILE
- MANIGLIA ESTERNA/POMOLO INTERNO**  
EXTERNAL HANDLE/INTERNAL POMMEL
- MANIGLIE ESTERNA/INTERNA**  
EXTERNAL/INTERNAL HANDLES
- NEVERDROP®** TRATTAMENTO NEVERDROP®  
NEVERDROP® TREATMENT
- MISURE SPECIALI**  
SPECIAL SIZES

### Finiture profili

#### ORIGIN

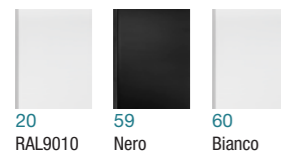

### Profiles finishing

#### ABITAT



#### VOGUE

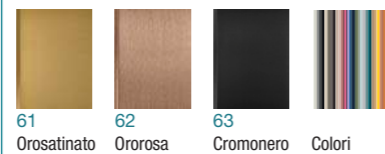

### Vetri

### Glasses



## installazioni previste allowed installations

### in nicchia

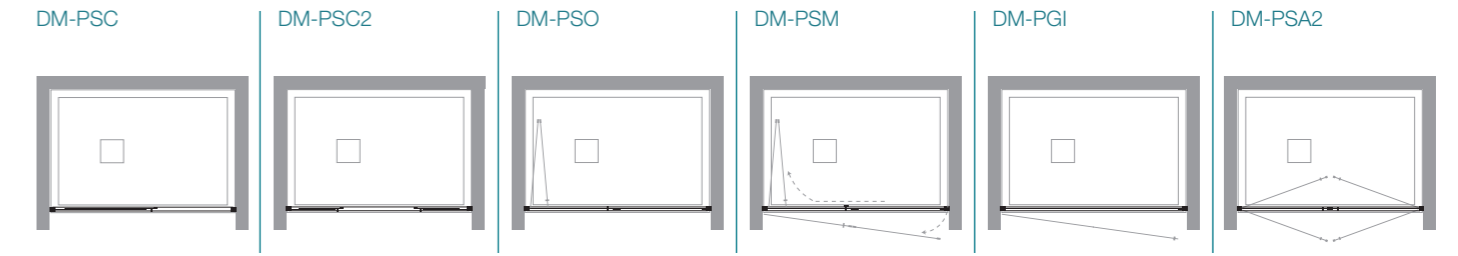

### ad angolo

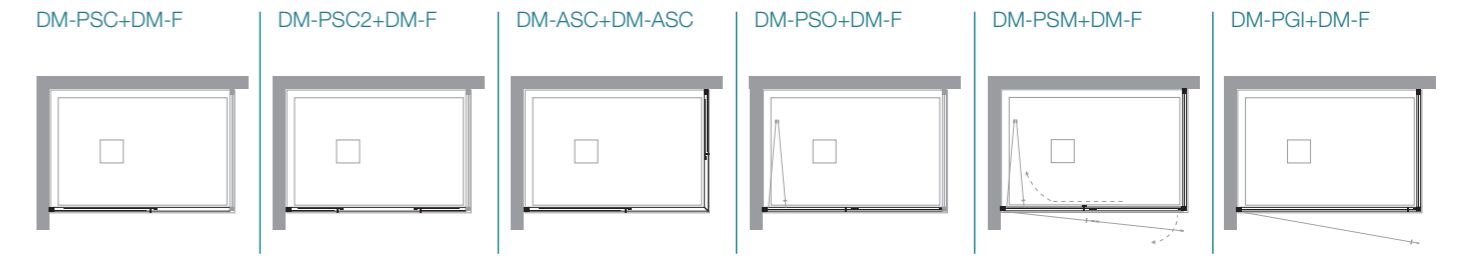

### a tre lati

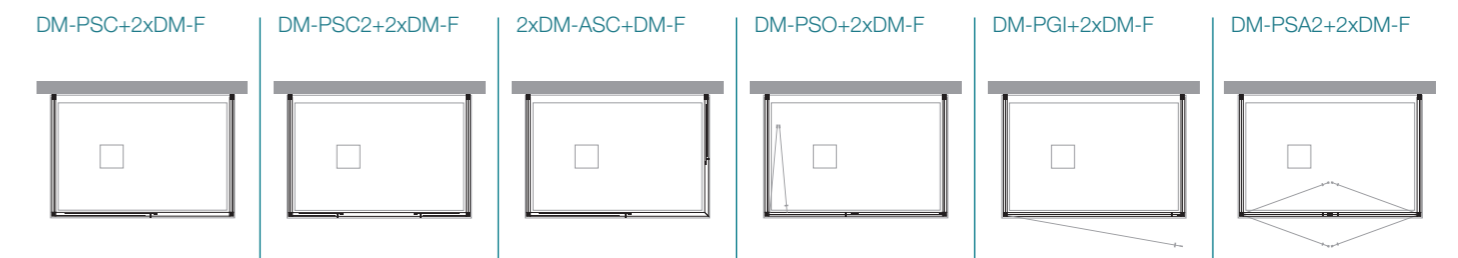

### semicircolari

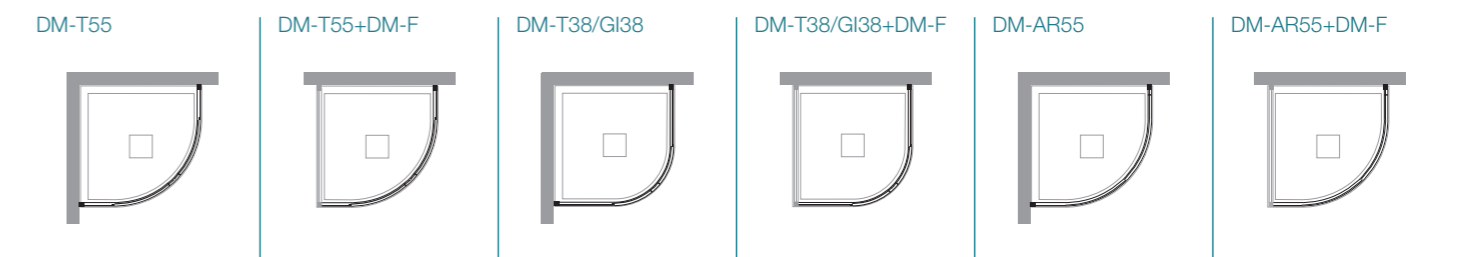

### profili

### profiles

per/for **DM: ASC-T55-T38-AR-GI**

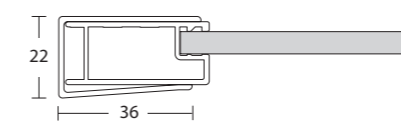

profilo a muro 1327 + schienale 1123  
wall profile 1327 + vertical profile 1123

per/for **DM: PSC-PSC2-PSO-PSM-PGI-PSA2**

per/for

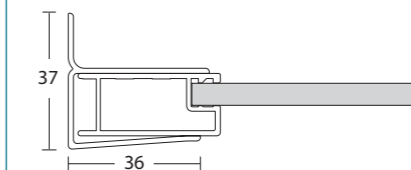

profilo a muro 1119 + schienale 1123  
wall profile 1119 + vertical profile 1123

### importante

### important

ordini per pareti doccia speciali senza relativo disegno **NON** vengono prodotti

orders for special shower walls without related design are **NOT** produced

per installazioni a tre lati richiedere fattibilità. Alcune configurazioni necessitano di elementi aggiuntivi

contact TDA technical office for three side installation. Some configurations require additional elements

# Dado Maxi

Parete doccia con porta scorrevole  
Sliding door



















incluso



included





disponibile

available

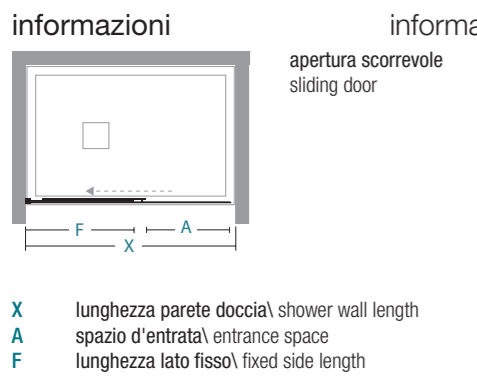
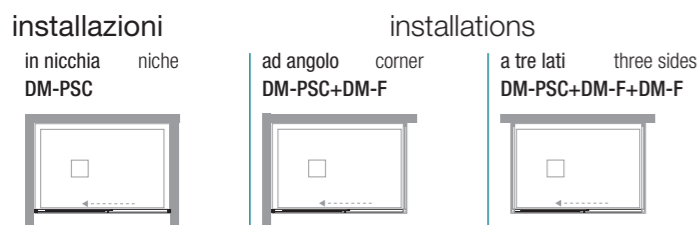

|         | X  | A    | F |  |  |  |  |   |    |
|---------|----|------|---|--|--|--|--|---|----|
| 96-102  | 40 | 43,5 |   |  |  |  |  | 1 | 40 |
| 106-112 | 45 | 48,5 |   |  |  |  |  | 1 | 44 |
| 116-122 | 50 | 53,5 |   |  |  |  |  | 1 | 48 |
| 126-132 | 55 | 58,5 |   |  |  |  |  | 2 | 52 |
| 136-142 | 60 | 63,5 |   |  |  |  |  | 2 | 56 |
| 146-152 | 65 | 68,5 |   |  |  |  |  | 2 | 59 |
| 156-162 | 65 | 78,5 |   |  |  |  |  | 2 | 62 |
| 166-172 | 65 | 88,5 |   |  |  |  |  | 2 | 65 |
| 176-182 | 65 | 98,5 |   |  |  |  |  | 2 | 68 |

# DM-PSC

INSTALLAZIONE IN NICCHIA, AD ANGOLO O A TRE LATI  
NICHE, CORNER OR THREE SIDES INSTALLATION

| Misure standard |                         | Standard sizes                      |    |    |    |    |    |
|-----------------|-------------------------|-------------------------------------|----|----|----|----|----|
| Codice Code     | estensibilità extension | Finiture profili Profiles finishing | 30 | 32 | 29 | 28 | 11 |
| 11P120100       | 96-102                  | origin                              |    |    |    |    |    |
|                 |                         | abitat                              | ■  |    |    |    |    |
|                 |                         | vogue                               |    |    |    |    |    |
| 11P120110       | 106-112                 | origin                              |    |    |    |    |    |
|                 |                         | abitat                              | ■  |    |    |    |    |
|                 |                         | vogue                               |    |    |    |    |    |
| 11P120120       | 116-122                 | origin                              |    |    |    |    |    |
|                 |                         | abitat                              | ■  |    |    |    |    |
|                 |                         | vogue                               |    |    |    |    |    |
| 11P120130       | 126-132                 | origin                              |    |    |    |    |    |
|                 |                         | abitat                              | ■  |    |    |    |    |
|                 |                         | vogue                               |    |    |    |    |    |
| 11P120140       | 136-142                 | origin                              |    |    |    |    |    |
|                 |                         | abitat                              | ■  |    |    |    |    |
|                 |                         | vogue                               |    |    |    |    |    |
| 11P120150       | 146-152                 | origin                              |    |    |    |    |    |
|                 |                         | abitat                              | ■  |    |    |    |    |
|                 |                         | vogue                               |    |    |    |    |    |
| 11P120160       | 156-162                 | origin                              |    |    |    |    |    |
|                 |                         | abitat                              | ■  |    |    |    |    |
|                 |                         | vogue                               |    |    |    |    |    |
| 11P120170       | 166-172                 | origin                              |    |    |    |    |    |
|                 |                         | abitat                              |    |    |    |    |    |
|                 |                         | vogue                               |    |    |    |    |    |
| 11P120180       | 176-182                 | origin                              |    |    |    |    |    |
|                 |                         | abitat                              |    |    |    |    |    |
|                 |                         | vogue                               |    |    |    |    |    |

| Misure speciali L / H |                   | Special sizes L / H                 |    |    |    |    |    |
|-----------------------|-------------------|-------------------------------------|----|----|----|----|----|
| Codice Code           | su misura bespoke | Finiture profili Profiles finishing | 30 | 32 | 16 | 29 | 28 |
| 11P129001             | 80 < L < 100      | origin                              |    |    |    |    |    |
|                       |                   | abitat                              |    |    |    |    |    |
|                       |                   | vogue                               |    |    |    |    |    |
| 11P129001             | 101 < L < 120     | origin                              |    |    |    |    |    |
|                       |                   | abitat                              |    |    |    |    |    |
|                       |                   | vogue                               |    |    |    |    |    |
| 11P129001             | 121 < L < 140     | origin                              |    |    |    |    |    |
|                       |                   | abitat                              |    |    |    |    |    |
|                       |                   | vogue                               |    |    |    |    |    |
| 11P129001             | 141 < L < 160     | origin                              |    |    |    |    |    |
|                       |                   | abitat                              |    |    |    |    |    |
|                       |                   | vogue                               |    |    |    |    |    |
| 11P129001             | 161 < L < 180     | origin                              |    |    |    |    |    |
|                       |                   | abitat                              |    |    |    |    |    |
|                       |                   | vogue                               |    |    |    |    |    |

**attenzione**

Il prezzo della H speciale va trovato nella tabella Misure speciali L / H in base alla L della parete doccia

Special price for H is to be found in Special sizes L / H as per L needed size

**warning**

| Misure speciali Special size | Disponibilità Availability |        |  |  |  |  |  |
|------------------------------|----------------------------|--------|--|--|--|--|--|
| H max 210 cm                 | ■ STOCK                    | Tcrom® |  |  |  |  |  |
| L min 80 cm                  |                            |        |  |  |  |  |  |
| L max 180 cm                 |                            |        |  |  |  |  |  |

**supplementi**

| Profilo di compensazione 3 cm Extension profile 3 cm | Sigillante SPARTAN® Sealant SPARTAN® |   |   |  |  |  |  |
|--|--------------------------------------|---|---|--|--|--|--|
| 35A010200  | 36B010010                            | € | € |  |  |  |  |

**Approfondimenti Insights**





|  |     |
|--|-----|
| Indice Index                           | 3   |
| Legenda simboli Icons legend           | 11  |
| Profili - Vetri Profiles - Glasses     | 21  |
| Ricambi Spare parts                    | 406 |
| Profili speciali Special profiles      | 434 |
| Schede rilievo misure Measurement form | 444 |

| 05                               | 11                                 | 12     | 16       | 24  | 25    | 26   | 27   | 28         | 29   | 30          | 31           | 32       | 34         |
|----------------------------------|------------------------------------|--------|----------|---|-------|------|------|------------|------|-------------|--------------|----------|------------|
| acrilico satin                   | flack                              | reflex | satinato | nigol   | flute | wave | alon | fumè brown | fumè | trasparente | extrachiario | cincillà | stampato C |
| origin                           | abitat                             |        |          | vogue   |       |      |      |            |      |             |              |          |            |
| 20 RAL9010 / 59 Nero / 60 Bianco | 27 Tcrom® / 21 Tinox® / 22 Tbronz® |        |          | 61 Orosatinato / 62 Ororosa / 63 Cromonero / Colori |       |      |      |            |      |             |              |          |            |

# Dado Maxi

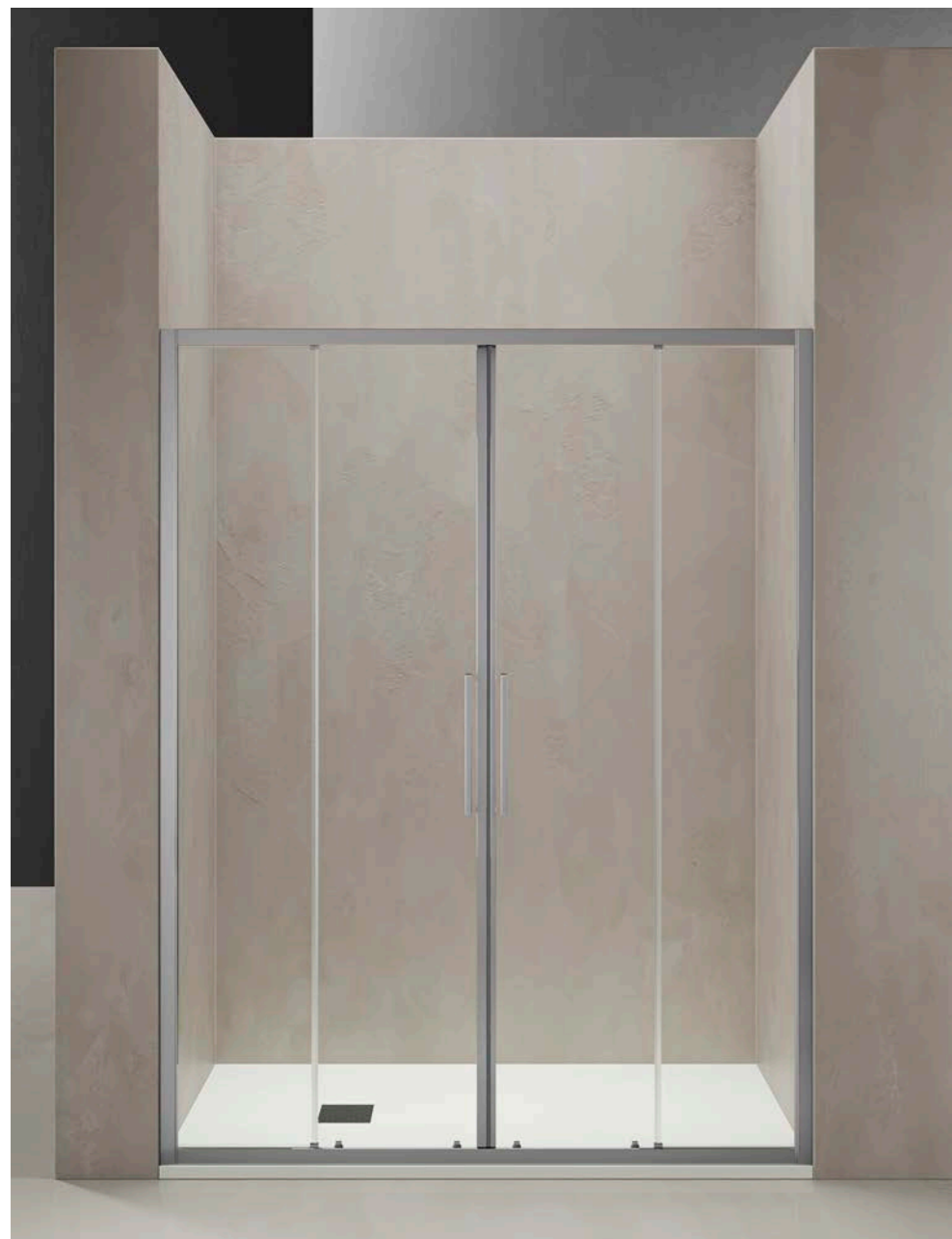
Parete doccia con doppia porta scorrevole  
Double sliding door



















incluso

included





disponibile

available

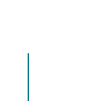

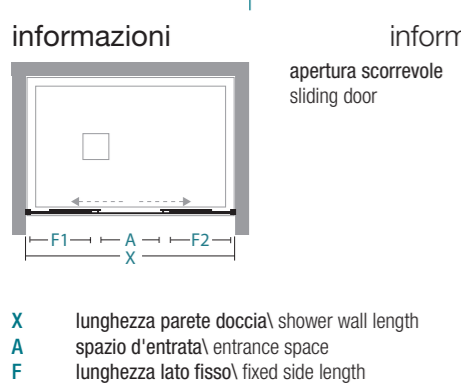
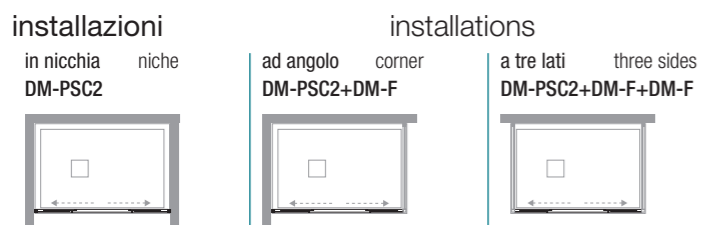
|         | X  | A    | F |  |  |  |  |  |      |
|---------|----|------|---|--|--|--|--|--|------|
| 106-112 | 43 | 25   |   |  |  |  |  |  | 2 48 |
| 116-122 | 48 | 27,5 |   |  |  |  |  |  | 2 52 |
| 126-132 | 53 | 30   |   |  |  |  |  |  | 2 56 |
| 136-142 | 58 | 32,5 |   |  |  |  |  |  | 2 60 |
| 146-152 | 63 | 35   |   |  |  |  |  |  | 2 63 |
| 156-162 | 68 | 37,5 |   |  |  |  |  |  | 2 66 |
| 166-172 | 73 | 40   |   |  |  |  |  |  | 2 69 |
| 176-182 | 78 | 42,5 |   |  |  |  |  |  | 2 72 |

# DM-PSC2

INSTALLAZIONE IN NICCHIA, AD ANGOLO O A TRE LATI  
NICHE, CORNER OR THREE SIDES INSTALLATION

| Misure standard |                         | Standard sizes                      |    |    |    |    |
|-----------------|-------------------------|-------------------------------------|----|----|----|----|
| Codice Code     | estensibilità extension | Finiture profili Profiles finishing | 30 | 32 | 29 | 28 |
| 11P130110       | 106-112                 | origin<br>abitat<br>vogue           |    |    |    |    |
| 11P130120       | 116-122                 | origin<br>abitat<br>vogue           |    |    |    |    |
| 11P130130       | 126-132                 | origin<br>abitat<br>vogue           |    |    |    |    |
| 11P130140       | 136-142                 | origin<br>abitat<br>vogue           |    |    |    |    |
| 11P130150       | 146-152                 | origin<br>abitat<br>vogue           |    |    |    |    |
| 11P130160       | 156-162                 | origin<br>abitat<br>vogue           |    |    |    |    |
| 11P130170       | 166-172                 | origin<br>abitat<br>vogue           |    |    |    |    |
| 11P130180       | 176-182                 | origin<br>abitat<br>vogue           |    |    |    |    |

| Misure speciali L / H |                   | Special sizes L / H                 |    |    |    |    |    |
|-----------------------|-------------------|-------------------------------------|----|----|----|----|----|
| Codice Code           | su misura bespoke | Finiture profili Profiles finishing | 30 | 32 | 16 | 29 | 28 |
| 11P139001             | 100 < L < 120     | origin<br>abitat<br>vogue           |    |    |    |    |    |
| 11P139001             | 121 < L < 140     | origin<br>abitat<br>vogue           |    |    |    |    |    |
| 11P139001             | 141 < L < 160     | origin<br>abitat<br>vogue           |    |    |    |    |    |
| 11P139001             | 161 < L < 180     | origin<br>abitat<br>vogue           |    |    |    |    |    |
| 11P139001             | 181 < L < 200     | origin<br>abitat<br>vogue           |    |    |    |    |    |

**attenzione**

Il prezzo della H speciale va trovato nella tabella Misure speciali L / H in base alla L della parete doccia

Special price for H is to be found in Special sizes L / H as per L needed size

**warning**

| Misure speciali Special size                         |        |                                      |   |  |  |  |  |  |  |
|--|--------|--------------------------------------|---|--|--|--|--|--|--|
| H max  | 210 cm |                                      |   |  |  |  |  |  |  |
| L min  | 100 cm |                                      |   |  |  |  |  |  |  |
| L max  | 200 cm |                                      |   |  |  |  |  |  |  |
| Profilo di compensazione 3 cm Extension profile 3 cm |        | Sigillante SPARTAN® Sealant SPARTAN® |   |  |  |  |  |  |  |
| 35A010200  | €      | 36B010010                            | € |  |  |  |  |  |  |

| 05                               | 11    | 12     | 16                                 | 24    | 25    | 26   | 27  | 28         | 29   | 30          | 31           | 32       | 34         |
|----------------------------------|-------|--------|------------------------------------|-------|-------|------|---|------------|------|-------------|--------------|----------|------------|
| acrilico satin                   | flack | reflex | satinato                           | nigol | flute | wave | alon  | fumè brown | fumè | trasparente | extrachiario | cincillà | stampato C |
| origin                           |       |        | abitat                             |       |       |      | vogue   |            |      |             |              |          |            |
| 20 RAL9010 / 59 Nero / 60 Bianco |       |        | 27 Tcrom® / 21 Tinox® / 22 Tbronz® |       |       |      | 61 Orosatinato / 62 Ororosa / 63 Cromonero / Colori |            |      |             |              |          |            |

**Approfondimenti Insights**





- Indice Index 3
- Legenda simboli Icons legend 11
- Profili - Vetri Profiles - Glasses 21
- Ricambi Spare parts 406
- Profili speciali Special profiles 434
- Schede rilievo misure Measurement form 444

# Dado Maxi

Parete doccia con porta scorrevole per angolo  
Shower enclosure with sliding door for corner







H cm  
200



6 mm



REV

incluso      included



3 cm



NEVERDROP



L/H



3 cm



3 cm

disponibile      available

installazioni      installations

ad angolo      corner  
DM-ASC+DM-ASC

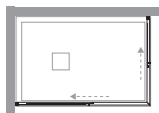

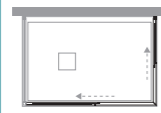

a tre lati      three sides  
DM-ASC+DM-ASC+DM-F

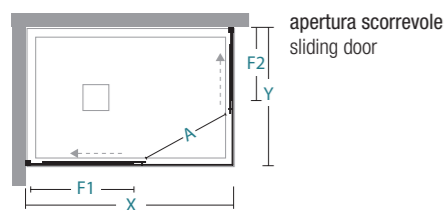

informazioni      informations



X/Y      lunghezza parete doccia\ shower wall length  
A      spazio d'entrata\ entrance space  
F1 / F2      lunghezza lato fisso\ fixed side length

| X/Y     | 67-70 | 72-75 | 77-80 | 87-90 | 97-100 | 117-120 | F1/F2 |  |  |
|---------|-------|-------|-------|-------|--------|---------|-------|---|---|
| 67-70   | A=38  |       |       |       |        |         | 29    | 1   | 27  |
| 72-75   | A=40  | A=41  |       |       |        |         | 32    | 1   | 29  |
| 77-80   | A=42  | A=43  | A=45  |       |        |         | 34    | 1   | 31  |
| 87-90   | A=46  | A=47  | A=49  | A=52  |        |         | 39    | 1   | 34  |
| 97-100  | A=50  | A=51  | A=53  | A=56  | A=59   |         | 44    | 1   | 39  |
| 117-120 | A=58  | A=60  | A=61  | A=64  | A=67   | A=73    | 54,5  | 1   | 46  |

# DM-ASC

INSTALLAZIONE AD ANGOLO O A TRE LATI  
CORNER OR THREE SIDES INSTALLATION

Misure standard      Standard sizes

| Codice Code | estensibilità extension | Finiture profili Profiles finishing | 30 | 32 | 29 | 28 | 11 |
|-------------|-------------------------|-------------------------------------|----|----|----|----|----|
| 11A100070   | 67-70                   | origin                              |    |    |    |    |    |
|             |                         | abitat                              |    |    |    |    |    |
|             |                         | vogue                               |    |    |    |    |    |
| 11A100075   | 72-75                   | origin                              |    |    |    |    |    |
|             |                         | abitat                              |    |    |    |    |    |
|             |                         | vogue                               |    |    |    |    |    |
| 11A100080   | 77-80                   | origin                              |    |    |    |    |    |
|             |                         | abitat                              |    |    |    |    |    |
|             |                         | vogue                               |    |    |    |    |    |
| 11A100090   | 87-90                   | origin                              |    |    |    |    |    |
|             |                         | abitat                              |    |    |    |    |    |
|             |                         | vogue                               |    |    |    |    |    |
| 11A100100   | 97-100                  | origin                              |    |    |    |    |    |
|             |                         | abitat                              |    |    |    |    |    |
|             |                         | vogue                               |    |    |    |    |    |
| 11A100120   | 117-120                 | origin                              |    |    |    |    |    |
|             |                         | abitat                              |    |    |    |    |    |
|             |                         | vogue                               |    |    |    |    |    |

Misure speciali L / H      Special sizes L / H

| Codice Code | su misura bespoke | Finiture profili Profiles finishing | 30 | 32 | 16 | 29 | 28 |
|-------------|-------------------|-------------------------------------|----|----|----|----|----|
| 11A109001   | 45 < L < 60       | origin                              |    |    |    |    |    |
|             |                   | abitat                              |    |    |    |    |    |
|             |                   | vogue                               |    |    |    |    |    |
| 11A109001   | 61 < L < 90       | origin                              |    |    |    |    |    |
|             |                   | abitat                              |    |    |    |    |    |
|             |                   | vogue                               |    |    |    |    |    |
| 11A109001   | 91 < L < 120      | origin                              |    |    |    |    |    |
|             |                   | abitat                              |    |    |    |    |    |
|             |                   | vogue                               |    |    |    |    |    |
| 11A109001   | 121 < L < 150     | origin                              |    |    |    |    |    |
|             |                   | abitat                              |    |    |    |    |    |
|             |                   | vogue                               |    |    |    |    |    |
| 11A109001   | 151 < L < 180     | origin                              |    |    |    |    |    |
|             |                   | abitat                              |    |    |    |    |    |
|             |                   | vogue                               |    |    |    |    |    |

attenzione

Il prezzo della H speciale va trovato nella tabella Misure speciali L / H in base alla L della parete doccia

Special price for H is to be found in Special sizes L / H as per L needed size

warning

Il prezzo è inteso per lato  
Prices are to be intended for one side

Per misure di X > 120 cm viene aumentato solo il fisso  
For X > 120 cm only the fixed panel will increased

Specificare se installato a pavimento  
Specify any floor installation

Misure speciali Special size

|   |     |        |
|---|-----|--------|
| H | max | 210 cm |
| L | min | 45 cm  |
| L | max | 180 cm |

Disponibilità Availability

■ STOCK Tcrom®

supplementi

Profilo di compensazione 3 cm  
Extension profile 3 cm

€

05 acrilico satin / 59 Nero / 60 Bianco

supplements

Sigillante SPARTAN®  
Sealant SPARTAN®

€

11 flack / 12 reflex / 16 satinato / 24 nigol / 25 flute / 26 wave

origin

20 RAL9010 / 59 Nero / 60 Bianco

abitat

27 Tcrom® / 21 Tinox® / 22 Tbronz®

vogue

61 Orosatinato / 62 Ororosa / 63 Cromonero / Colori

Approfondimenti Insights



|  |     |
|--|-----|
| Indice Index                           | 3   |
| Legenda simboli Icons legend           | 11  |
| Profili - Vetri Profiles - Glasses     | 21  |
| Ricambi Spare parts                    | 406 |
| Profili speciali Special profiles      | 434 |
| Schede rilievo misure Measurement form | 444 |

27 aion / 28 fumè brown / 29 fumè / 30 trasparente / 31 extrachiaro / 32 cincillà / 34 stampato C

# Dado Maxi

Parete doccia con porta girevole  
Pivoting door





incluso      included

disponibile      available

installazioni

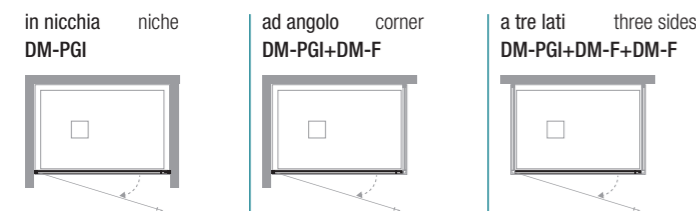

informazioni

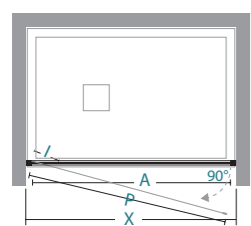

informations

apertura battente girevole  
swing turning door

| X     | A  | P  |  |  |  |  |  |   |    |
|-------|----|----|--|--|--|--|--|---|----|
| 66-72 | 52 | 51 |  |  |  |  |  | 1 | 25 |
| 71-77 | 57 | 56 |  |  |  |  |  | 1 | 26 |
| 76-82 | 62 | 61 |  |  |  |  |  | 1 | 28 |
| 81-87 | 67 | 66 |  |  |  |  |  | 1 | 30 |
| 86-92 | 72 | 71 |  |  |  |  |  | 1 | 32 |

X lunghezza parete doccia \ shower wall length  
A spazio d'entrata \ entrance space  
P lunghezza porta \ door length

# DM-PGI

INSTALLAZIONE IN NICCHIA, AD ANGOLO O A TRE LATI  
NICHE, CORNER OR THREE SIDES INSTALLATION

Misure standard

| Codice Code | estensibilità extension | Finiture profili Profiles finishing | 30 | 32 | 29 | 28 |
|-------------|-------------------------|-------------------------------------|----|----|----|----|
| 11P100070   | 66-72                   | origin<br>abitat<br>vogue           |    |    |    |    |
| 11P100075   | 71-77                   | origin<br>abitat<br>vogue           |    |    |    |    |
| 11P100080   | 76-82                   | origin<br>abitat<br>vogue           |    |    |    |    |
| 11P100085   | 81-87                   | origin<br>abitat<br>vogue           |    |    |    |    |
| 11P100090   | 86-92                   | origin<br>abitat<br>vogue           |    |    |    |    |

Misure speciali L / H

| Codice Code | su misura bespoke | Finiture profili Profiles finishing | 30 | 32 | 16 | 29 | 28 |
|-------------|-------------------|-------------------------------------|----|----|----|----|----|
| 11P109001   | 50 < L < 60       | origin<br>abitat<br>vogue           |    |    |    |    |    |
| 11P109001   | 61 < L < 75       | origin<br>abitat<br>vogue           |    |    |    |    |    |
| 11P109001   | 76 < L < 95       | origin<br>abitat<br>vogue           |    |    |    |    |    |

attenzione

Il prezzo della H speciale va trovato nella tabella Misure speciali L / H in base alla L della parete doccia

Special price for H is to be found in Special sizes L / H as per L needed size

warning

Misure speciali Special size

|       |        |  |  |  |  |
|-------|--------|--|--|--|--|
| H max | 210 cm |  |  |  |  |
| L min | 50 cm  |  |  |  |  |
| L max | 95 cm  |  |  |  |  |

Disponibilità Availability

■ STOCK Tcrom®

supplementi

Profilo di compensazione 3 cm  
Extension profile 3 cm

€ 35A010200

supplements

Sigillante SPARTAN®  
Sealant SPARTAN®

€ 36B010010

Approfondimenti Insights



|  |     |
|--|-----|
| Indice Index                           | 3   |
| Legenda simboli Icons legend           | 11  |
| Profili - Vetri Profiles - Glasses     | 21  |
| Ricambi Spare parts                    | 406 |
| Profili speciali Special profiles      | 434 |
| Schede rilievo misure Measurement form | 444 |

| 05                               | 11                                 | 12     | 16       | 24  | 25    | 26   | 27   | 28         | 29   | 30          | 31          | 32       | 34         |
|----------------------------------|------------------------------------|--------|----------|---|-------|------|------|------------|------|-------------|-------------|----------|------------|
| acrilico satin                   | flack                              | reflex | satinato | nigol   | flute | wave | alon | fumè brown | fumè | trasparente | extrachiaro | cincillà | stampato C |
| origin                           | abitat                             |        |          | vogue   |       |      |      |            |      |             |             |          |            |
| 20 RAL9010 / 59 Nero / 60 Bianco | 27 Tcrom® / 21 Tinox® / 22 Tbronz® |        |          | 61 Orosatinato / 62 Ororosa / 63 Cromonero / Colori |       |      |      |            |      |             |             |          |            |

# Dado Maxi

Parete doccia con porta saloon  
Saloon door



incluso      included

disponibile      available

# DM-PSA2

INSTALLAZIONE IN NICCHIA, AD ANGOLO O A TRE LATI  
NICHE, CORNER OR THREE SIDES INSTALLATION

| Misure standard |                         | Standard sizes                      |    |    |    |    |
|-----------------|-------------------------|-------------------------------------|----|----|----|----|
| Codice Code     | estensibilità extension | Finiture profili Profiles finishing | 30 | 32 | 29 | 28 |
| 11P110070       | 66-72                   | origin<br>abitat<br>vogue           |    |    |    |    |
| 11P110075       | 71-77                   | origin<br>abitat<br>vogue           |    |    |    |    |
| 11P110080       | 76-82                   | origin<br>abitat<br>vogue           |    |    |    |    |
| 11P110085       | 81-87                   | origin<br>abitat<br>vogue           |    |    |    |    |
| 11P110090       | 86-92                   | origin<br>abitat<br>vogue           |    |    |    |    |
| 11P110100       | 96-102                  | origin<br>abitat<br>vogue           |    |    |    |    |
| 11P110120       | 116-122                 | origin<br>abitat<br>vogue           |    |    |    |    |

| Misure speciali L / H |                   | Special sizes L / H                 |    |    |    |    |    |
|-----------------------|-------------------|-------------------------------------|----|----|----|----|----|
| Codice Code           | su misura bespoke | Finiture profili Profiles finishing | 30 | 32 | 16 | 29 | 28 |
| 11P119001             | 50 < L < 90       | origin<br>abitat<br>vogue           |    |    |    |    |    |
| 11P119001             | 91 < L < 120      | origin<br>abitat<br>vogue           |    |    |    |    |    |
| 11P119001             | 121 < L < 140     | origin<br>abitat<br>vogue           |    |    |    |    |    |
| 11P119001             | 141 < L < 160     | origin<br>abitat<br>vogue           |    |    |    |    |    |

installazioni  
in nicchia niche  
DM-PSA2

ad angolo corner  
DM-PSA2+DM-F

a tre lati three sides  
DM-PSA2+DM-F+DM-F

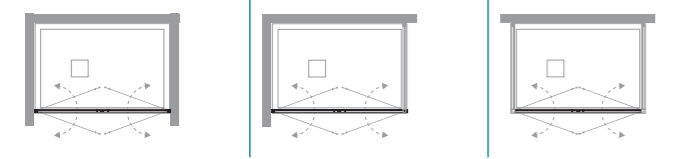

informazioni  
apertura saloon saloon door

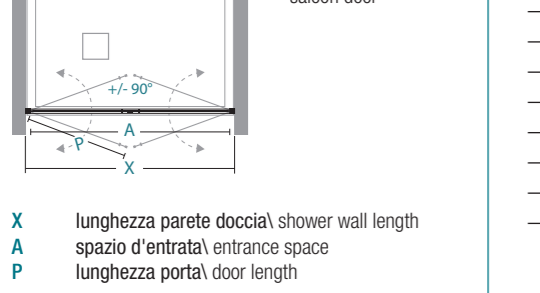

|         | X  | A    | P |  |  |  |  |  |   |    |
|---------|----|------|---|--|--|--|--|--|---|----|
| 66-72   | 49 | 29   |   |  |  |  |  |  | 1 | 26 |
| 71-77   | 54 | 31,5 |   |  |  |  |  |  | 1 | 27 |
| 76-82   | 59 | 34   |   |  |  |  |  |  | 1 | 29 |
| 81-87   | 64 | 36,5 |   |  |  |  |  |  | 1 | 31 |
| 86-92   | 69 | 39   |   |  |  |  |  |  | 1 | 32 |
| 96-102  | 79 | 44   |   |  |  |  |  |  | 1 | 36 |
| 116-122 | 99 | 54   |   |  |  |  |  |  | 1 | 43 |

attenzione  
Il prezzo della H speciale va trovato nella tabella Misure speciali L / H in base alla L della parete doccia  
Special price for H is to be found in Special sizes L / H as per L needed size

warning

| Misure speciali Special size | Disponibilità Availability |        |
|------------------------------|----------------------------|--------|
| H max 210 cm                 | STOCK                      | Tcrom® |
| L min 50 cm                  |                            |        |
| L max 160 cm                 |                            |        |

supplementi  
Profilo di compensazione 3 cm Extension profile 3 cm

|           | Sigillante SPARTAN® Sealant SPARTAN® |
|-----------|--------------------------------------|
| 35A010200 | 36B010010                            |

| 05                               | 11                                 | 12     | 16       | 24  | 25    | 26   | 27   | 28         | 29   | 30          | 31          | 32       | 34         |
|----------------------------------|------------------------------------|--------|----------|---|-------|------|------|------------|------|-------------|-------------|----------|------------|
| acrilico satin                   | flack                              | reflex | satinato | nigol   | flute | wave | alon | fumè brown | fumè | trasparente | extrachiaro | cincillà | stampato C |
| origin                           | abitat                             |        |          | vogue   |       |      |      |            |      |             |             |          |            |
| 20 RAL9010 / 59 Nero / 60 Bianco | 27 Tcrom® / 21 Tinox® / 22 Tbronz® |        |          | 61 Orosatinato / 62 Ororosa / 63 Cromonero / Colori |       |      |      |            |      |             |             |          |            |

Approfondimenti Insights

- Indice Index 3
- Legenda simboli Icons legend 11
- Profili - Vetri Profiles - Glasses 21
- Ricambi Spare parts 406
- Profili speciali Special profiles 434
- Schede rilievo misure Measurement form 444

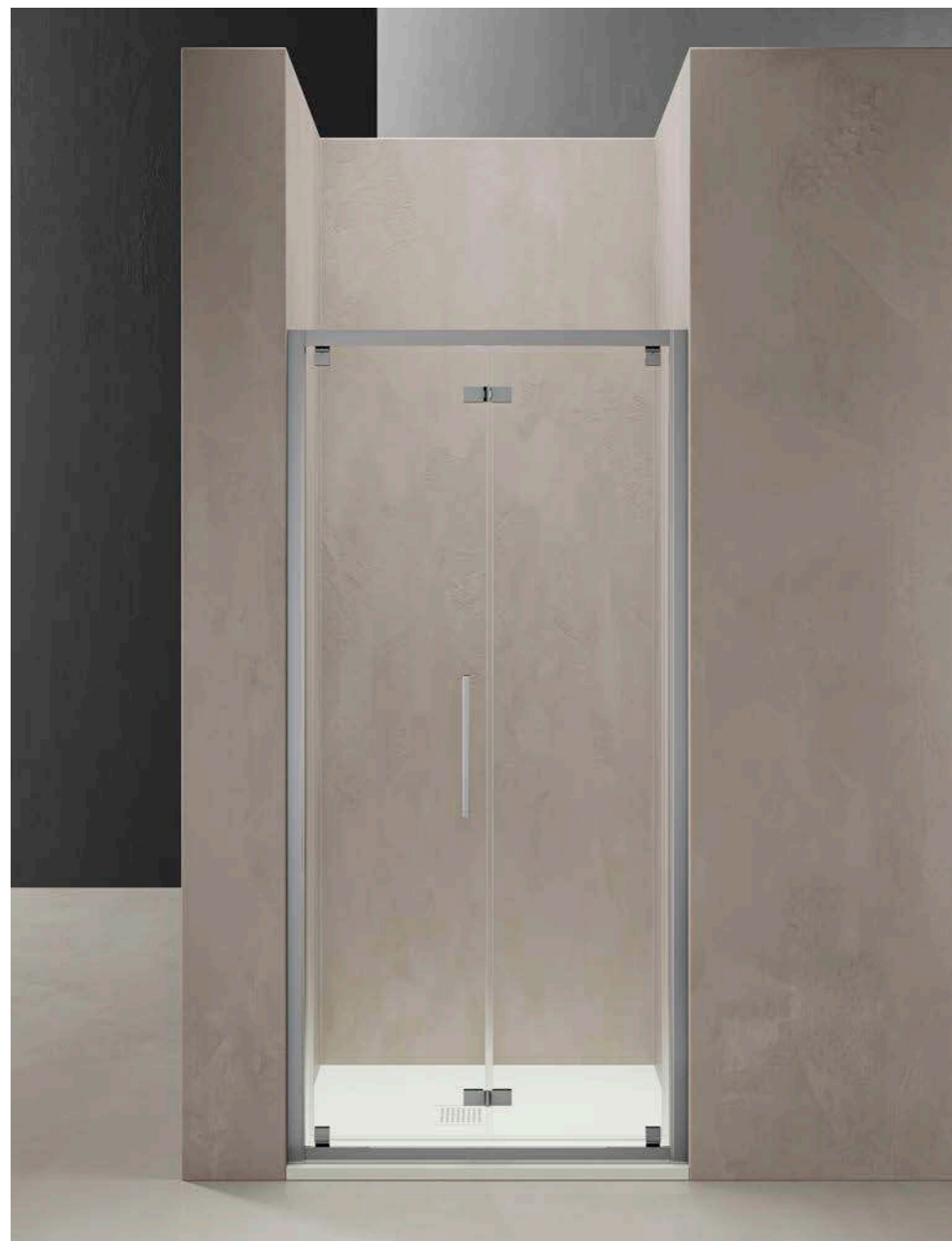

# Dado Maxi

Parete doccia con porta a soffietto  
Folding door

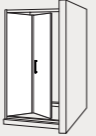







incluso

included

disponibile

available

installazioni

in nicchia  
niche  
DM-PSO



ad angolo  
corner  
DM-PSO+DM-F

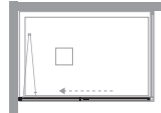

a tre lati  
three sides  
DM-PSO+DM-F+DM-F

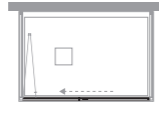

informazioni

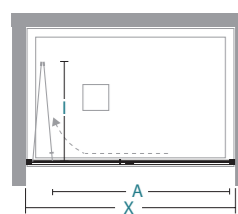

informations

apertura soffietto  
folding door

|        | X  | A    | I |  |  |  |  |   |    |
|--------|----|------|---|--|--|--|--|---|----|
| 66-72  | 46 | 30,5 |   |  |  |  |  | 1 | 25 |
| 71-77  | 51 | 33   |   |  |  |  |  | 1 | 27 |
| 76-82  | 55 | 35,5 |   |  |  |  |  | 1 | 28 |
| 81-87  | 61 | 38   |   |  |  |  |  | 1 | 30 |
| 86-92  | 66 | 40,5 |   |  |  |  |  | 1 | 32 |
| 96-102 | 74 | 45,5 |   |  |  |  |  | 1 | 35 |

X lunghezza parete doccia\ shower wall length  
A spazio d'entrata\ entrance space  
I ingombro interno\ internal dimensions

# DM-PSO

INSTALLAZIONE IN NICCHIA, AD ANGOLO O A TRE LATI  
NICHE, CORNER OR THREE SIDES INSTALLATION

Misure standard

| Codice<br>Code | estensibilità<br>extension | Finiture profili<br>Profiles finishing | 30 | 32 | 29 | 28 |
|----------------|----------------------------|--|----|----|----|----|
| 11P140070      | 66-72                      | origin<br>abibat<br>vogue              |    |    |    |    |
| 11P140075      | 71-77                      | origin<br>abibat<br>vogue              |    |    |    |    |
| 11P140080      | 76-82                      | origin<br>abibat<br>vogue              |    |    |    |    |
| 11P140085      | 81-87                      | origin<br>abibat<br>vogue              |    |    |    |    |
| 11P140090      | 86-92                      | origin<br>abibat<br>vogue              |    |    |    |    |
| 11P140100      | 96-102                     | origin<br>abibat<br>vogue              |    |    |    |    |

Misure speciali L / H

| Codice<br>Code | su misura<br>bespoke | Finiture profili<br>Profiles finishing | 30 | 32 | 16 | 29 | 28 |
|----------------|----------------------|--|----|----|----|----|----|
| 11P149001      | 60 < L < 80          | origin<br>abibat<br>vogue              |    |    |    |    |    |
| 11P149001      | 81 < L < 90          | origin<br>abibat<br>vogue              |    |    |    |    |    |
| 11P149001      | 91 < L < 110         | origin<br>abibat<br>vogue              |    |    |    |    |    |

attenzione

Il prezzo della H speciale va trovato nella tabella Misure speciali L / H in base alla L della parete doccia

Special price for H is to be found in Special sizes L / H as per L needed size

warning

Misure speciali  
Special size

|   |     |        |
|---|-----|--------|
| H | max | 210 cm |
| L | min | 60 cm  |
| L | max | 110 cm |

Disponibilità  
Availability

STOCK Tcrom®

supplementi

Profilo di compensazione 3 cm  
Extension profile 3 cm

€

35A010200

supplements

Sigillante SPARTAN®  
Sealant SPARTAN®

€

36B010010

Approfondimenti  
Insights



|   |     |
|---|-----|
| Indice<br>Index                           | 3   |
| Legenda simboli<br>Icons legend           | 11  |
| Profili - Vetri<br>Profiles - Glasses     | 21  |
| Ricambi<br>Spare parts                    | 406 |
| Profili speciali<br>Special profiles      | 434 |
| Schede rilievo misure<br>Measurement form | 444 |

| 05                               | 11                                 | 12     | 16       | 24  | 25    | 26   | 27   | 28         | 29   | 30          | 31          | 32       | 34         |
|----------------------------------|------------------------------------|--------|----------|---|-------|------|------|------------|------|-------------|-------------|----------|------------|
| acrilico satin                   | flack                              | reflex | satinato | nigol   | flute | wave | alon | fumè brown | fumè | trasparente | extrachiaro | cincillà | stampato C |
| origin                           | abibat                             |        |          | vogue   |       |      |      |            |      |             |             |          |            |
| 20 RAL9010 / 59 Nero / 60 Bianco | 27 Tcrom® / 21 Tinox® / 22 Tbronz® |        |          | 61 Orosatinato / 62 Ororosa / 63 Cromonero / Colori |       |      |      |            |      |             |             |          |            |

# Dado Maxi

Parete doccia con porta a soffietto IN/OUT  
IN/OUT folding door



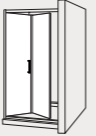

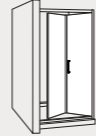

SX  
LH







DX  
RH

incluso





included





disponibile



available



## installazioni

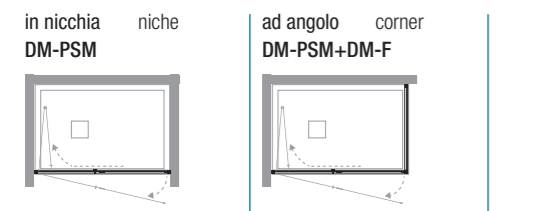

## informazioni

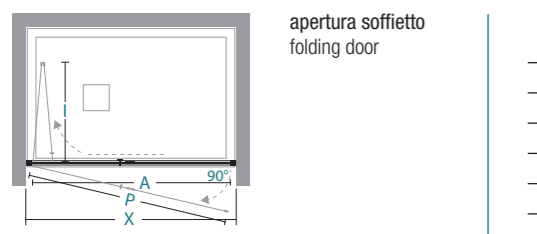

- X lunghezza parete doccia\ shower wall length
- A spazio d'entrata\ entrance space
- P lunghezza porta\ door length
- I ingombro interno\ internal dimensions

|        | X  | A    | I  | P |  |  |  |  |   |    |
|--------|----|------|----|---|--|--|--|--|---|----|
| 66-72  | 51 | 30,5 | 51 |   |  |  |  |  | 1 | 25 |
| 71-77  | 56 | 33   | 56 |   |  |  |  |  | 1 | 27 |
| 76-82  | 61 | 35,5 | 61 |   |  |  |  |  | 1 | 28 |
| 81-87  | 66 | 38   | 66 |   |  |  |  |  | 1 | 30 |
| 86-92  | 71 | 40,5 | 71 |   |  |  |  |  | 1 | 32 |
| 96-102 | 76 | 45,5 | 76 |   |  |  |  |  | 1 | 35 |

# DM-PSM

INSTALLAZIONE IN NICCHIA O AD ANGOLO  
NICHE OR CORNER INSTALLATION

| Misure standard      |                      |                            | Standard sizes                         |    |    |    |    |
|----------------------|----------------------|----------------------------|--|----|----|----|----|
| Codice SX<br>LH Code | Codice DX<br>RH Code | estensibilità<br>extension | Finiture profili<br>Profiles finishing | 30 | 32 | 29 | 28 |
| 11P070070            | 11P060070            | 66-72                      | origin<br>abitat<br>vogue              |    |    |    |    |
| 11P070075            | 11P060075            | 71-77                      | origin<br>abitat<br>vogue              |    |    |    |    |
| 11P070080            | 11P060080            | 76-82                      | origin<br>abitat<br>vogue              |    |    |    |    |
| 11P070085            | 11P060085            | 81-87                      | origin<br>abitat<br>vogue              |    |    |    |    |
| 11P070090            | 11P060090            | 86-92                      | origin<br>abitat<br>vogue              |    |    |    |    |
| 11P070100            | 11P060100            | 96-102                     | origin<br>abitat<br>vogue              |    |    |    |    |

| Misure speciali L / H |                      |                      | Special sizes L / H                    |    |    |    |    |    |
|-----------------------|----------------------|----------------------|--|----|----|----|----|----|
| Codice SX<br>LH Code  | Codice DX<br>RH Code | su misura<br>bespoke | Finiture profili<br>Profiles finishing | 30 | 32 | 16 | 29 | 28 |
| 11P079001             | 11P069001            | 66 < L < 80          | origin<br>abitat<br>vogue              |    |    |    |    |    |
| 11P079001             | 11P069001            | 81 < L < 90          | origin<br>abitat<br>vogue              |    |    |    |    |    |
| 11P079001             | 11P069001            | 91 < L < 110         | origin<br>abitat<br>vogue              |    |    |    |    |    |

## attenzione

Il prezzo della H speciale va trovato nella tabella Misure speciali L / H in base alla L della parete doccia

Special price for H is to be found in Special sizes L / H as per L needed size

| Misure speciali<br>Special size |        |  |
|---------------------------------|--------|--|
| H max                           | 210 cm |  |
| L min                           | 66 cm  |  |
| L max                           | 110 cm |  |

## supplementi

| Profilo di compensazione 3 cm<br>Extension profile 3 cm | Sigillante SPARTAN®<br>Sealant SPARTAN® |
|---|---|
| 35A010200   | 36B010010                               |

| 05                               | 11                                 | 12     | 16       | 24  | 25    | 26   | 27   | 28         | 29   | 30          | 31          | 32       | 34         |
|----------------------------------|------------------------------------|--------|----------|---|-------|------|------|------------|------|-------------|-------------|----------|------------|
| acrilico satin                   | flack                              | reflex | satinato | nigol   | flute | wave | alon | fumè brown | fumè | trasparente | extrachiaro | cincillà | stampato C |
| origin                           | abitat                             |        |          | vogue   |       |      |      |            |      |             |             |          |            |
| 20 RAL9010 / 59 Nero / 60 Bianco | 27 Tcrom® / 21 Tinox® / 22 Tbronz® |        |          | 61 Orosatinato / 62 Ororosa / 63 Cromonero / Colori |       |      |      |            |      |             |             |          |            |

## Approfondimenti Insights





|   |     |
|---|-----|
| Indice<br>Index                           | 3   |
| Legenda simboli<br>Icons legend           | 11  |
| Profili - Vetri<br>Profiles - Glasses     | 21  |
| Ricambi<br>Spare parts                    | 406 |
| Profili speciali<br>Special profiles      | 434 |
| Schede rilievo misure<br>Measurement form | 444 |

# Dado Maxi

Parete doccia semicircolare con doppia porta scorrevole  
Quadrant shower enclosure with double sliding door















incluso
included













disponibile
available





installazioni installations

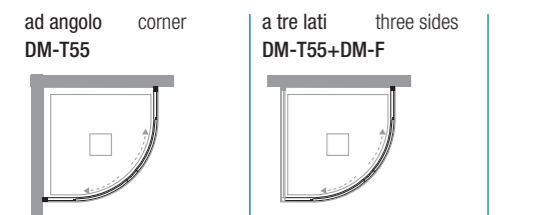

informazioni informations

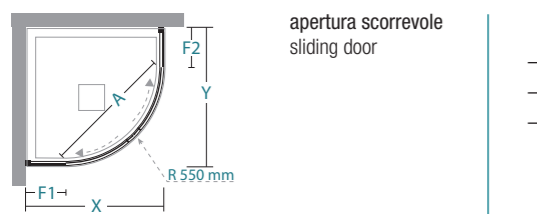

X / Y lunghezza parete doccia \ shower wall length  
A spazio d'entrata \ entrance space  
F1 / F2 lunghezza lato fisso \ fixed side length

| X/Y   | A  | F1/F2 |  |  |  |  |  |  |
|-------|----|-------|--|--|--|--|---|---|
| 77-80 | 44 | 26    |  |  |  |  | 2   | 48  |
| 87-90 | 52 | 36    |  |  |  |  | 2   | 55  |

# DM-T55

INSTALLAZIONE AD ANGOLO O A TRE LATI  
CORNER OR THREE SIDES INSTALLATION

Misure standard Standard sizes

| Codice Code | estensibilità extension | Finiture profili Profiles finishing | 30 |
|-------------|-------------------------|-------------------------------------|----|
| 11T020080   | 77-80                   | origin                              |    |
|             |                         | abitat                              |    |
|             |                         | vogue                               |    |
| 11T020090   | 87-90                   | origin                              |    |
|             |                         | abitat                              |    |
|             |                         | vogue                               |    |

Misure speciali L Special sizes L

| Codice Code | su misura bespoke | Finiture profili Profiles finishing | 30 |
|-------------|-------------------|-------------------------------------|----|
| 11T029001   | 67 < L < 77       | origin                              |    |
|             |                   | abitat                              |    |
|             |                   | vogue                               |    |
| 11T029001   | 78 < L < 80       | origin                              |    |
|             |                   | abitat                              |    |
|             |                   | vogue                               |    |
| 11T029001   | 81 < L < 87       | origin                              |    |
|             |                   | abitat                              |    |
|             |                   | vogue                               |    |
| 11T029001   | 88 < L < 90       | origin                              |    |
|             |                   | abitat                              |    |
|             |                   | vogue                               |    |
| 11T029001   | 91 < L < 100      | origin                              |    |
|             |                   | abitat                              |    |
|             |                   | vogue                               |    |
| 11T029001   | 101 < L < 120     | origin                              |    |
|             |                   | abitat                              |    |
|             |                   | vogue                               |    |

attenzione warning

Il prezzo della L speciale va trovato nella tabella Misure speciali L in base alla L della parete doccia  
Il prezzo delle misure speciali è inteso per lato  
Installazione su piatto doccia semicircolare raggio 55 cm

| Misure speciali Special size | Disponibilità Availability | Tcrom® |
|------------------------------|----------------------------|--------|
| L min 67 cm                  | STOCK                      |        |
| L max 120 cm                 |                            |        |

supplementi supplements

| Profilo di compensazione 3 cm Extension profile 3 cm | Sigillante SPARTAN® Sealant SPARTAN® |
|--|--------------------------------------|
| 35A010200 €  | 36B010010 €                          |

Approfondimenti Insights



|  |     |
|--|-----|
| Indice Index                           | 3   |
| Legenda simboli Icons legend           | 11  |
| Profili - Vetri Profiles - Glasses     | 21  |
| Ricambi Spare parts                    | 406 |
| Profili speciali Special profiles      | 434 |
| Schede rilievo misure Measurement form | 444 |

|                                  |                                    |        |          |   |       |      |      |            |      |             |             |          |            |
|----------------------------------|------------------------------------|--------|----------|---|-------|------|------|------------|------|-------------|-------------|----------|------------|
| 05                               | 11                                 | 12     | 16       | 24  | 25    | 26   | 27   | 28         | 29   | 30          | 31          | 32       | 34         |
| acrilico satin                   | flack                              | reflex | satinato | nigol   | flute | wave | alon | fumè brown | fumè | trasparente | extrachiaro | cincillà | stampato C |
| origin                           | abitat                             |        |          | vogue   |       |      |      |            |      |             |             |          |            |
| 20 RAL9010 / 59 Nero / 60 Bianco | 27 Tcrom® / 21 Tinox® / 22 Tbronz® |        |          | 61 Orosatinato / 62 Ororosa / 63 Cromonero / Colori |       |      |      |            |      |             |             |          |            |

# Dado Maxi

Parete doccia semicircolare con porta scorrevole  
Quadrant shower enclosure with sliding door















incluso      included















disponibile      available





installazioni      installations

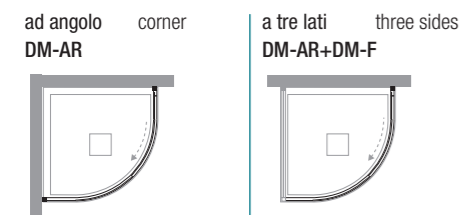

informazioni      informations

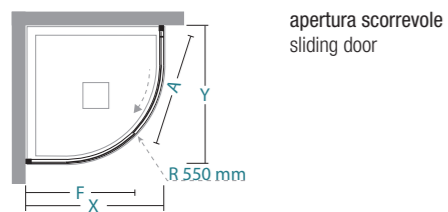

X/Y lunghezza parete doccia \ shower wall length  
A spazio d'entrata \ entrance space  
F lunghezza lato fisso \ fixed side length

| X/Y   | A  | F  |  |  |  |  |  |  |  |
|-------|----|----|--|--|--|--|--|---|---|
| 77-80 | 48 | 63 |  |  |  |  |  | 2   | 46  |
| 87-90 | 58 | 73 |  |  |  |  |  | 2   | 53  |

# DM-AR55

INSTALLAZIONE AD ANGOLO O A TRE LATI  
CORNER OR THREE SIDES INSTALLATION

Misure standard      Standard sizes

| Codice<br>Code | estensibilità<br>extension | Finiture profili<br>Profiles finishing | 30 |
|----------------|----------------------------|--|----|
| 11T010080      | 77-80                      | origin                                 |    |
|                |                            | abitat                                 | ■  |
|                |                            | vogue                                  |    |
| 11T010090      | 87-90                      | origin                                 |    |
|                |                            | abitat                                 | ■  |
|                |                            | vogue                                  |    |

attenzione      warning

Installazione su piatto doccia semicircolare raggio 55 cm

Installation on quadrant shower tray radius 55 cm

Disponibilità  
Availability  
■ STOCK      Tcrom®

supplementi      supplements

| Profilo di compensazione 3 cm<br>Extension profile 3 cm | Sigillante SPARTAN®<br>Sealant SPARTAN® |
|---|---|
| 35A010200 €   | 36B010010 €                             |

| 05             | 11    | 12     | 16       | 24    | 25    | 26   | 27   | 28         | 29   | 30          | 31          | 32       | 34         |
|----------------|-------|--------|----------|-------|-------|------|------|------------|------|-------------|-------------|----------|------------|
| acrilico satin | flack | reflex | satinato | nigol | flute | wave | alou | fumè brown | fumè | trasparente | extrachiaro | cincillà | stampato C |

origin      abitat      vogue  
20 RAL9010 / 59 Nero / 60 Bianco      27 Tcrom® / 21 Tinox® / 22 Tbronz®      61 Orosatinato / 62 Ororosa / 63 Cromonero / Colori

Approfondimenti  
Insights



|   |     |
|---|-----|
| Indice<br>Index                           | 3   |
| Legenda simboli<br>Icons legend           | 11  |
| Profili - Vetri<br>Profiles - Glasses     | 21  |
| Ricambi<br>Spare parts                    | 406 |
| Profili speciali<br>Special profiles      | 434 |
| Schede rilievo misure<br>Measurement form | 444 |



# Dado Maxi

Parete doccia semicircolare con doppia porta scorrevole  
Quadrant shower enclosure with double sliding door









incluso

included

disponibile

available



installazioni installations

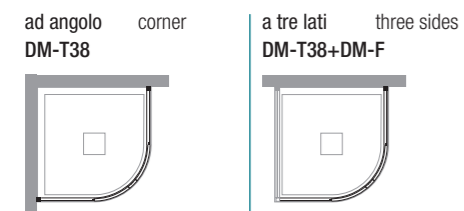

informazioni informations

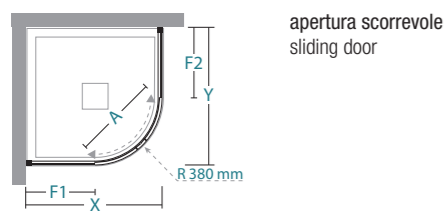

| X/Y   | A  | F1/F2 |  |  |  |  |  |  |  |
|-------|----|-------|--|--|--|--|--|--|--|
| 72-75 | 43 | 33    |  |  |  |  |  |  |  |

X / Y lunghezza parete doccia \ shower wall length  
A spazio d'entrata \ entrance space  
F1 / F2 lunghezza lato fisso \ fixed side length

# DM-T38

INSTALLAZIONE AD ANGOLO O A TRE LATI  
CORNER OR THREE SIDES INSTALLATION

| Misure standard |                         | Standard sizes                      |    |
|-----------------|-------------------------|-------------------------------------|----|
| Codice Code     | estensibilità extension | Finiture profili Profiles finishing | 30 |
| 11T020075       | 72-75                   | origin                              |    |
|                 |                         | abitat                              |    |
|                 |                         | vogue                               |    |

| Misure speciali L |                   | Special sizes L                     |    |
|-------------------|-------------------|-------------------------------------|----|
| Codice Code       | su misura bespoke | Finiture profili Profiles finishing | 30 |
| 11T029002         | 60 < L < 72       | origin                              |    |
|                   |                   | abitat                              |    |
|                   |                   | vogue                               |    |
| 11T029002         | 73 < L < 75       | origin                              |    |
|                   |                   | abitat                              |    |
|                   |                   | vogue                               |    |
| 11T029002         | 76 < L < 90       | origin                              |    |
|                   |                   | abitat                              |    |
|                   |                   | vogue                               |    |

attenzione warning

Il prezzo della L speciale va trovato nella tabella Misure speciali L in base alla L della parete doccia  
Il prezzo delle misure speciali è inteso per lato  
Installazione su piatto doccia semicircolare 75x75 raggio 38 cm

| Misure speciali Special size |       |
|------------------------------|-------|
| L min                        | 60 cm |
| L max                        | 90 cm |

Special price for L is to be found in Special sizes L as per L needed size  
Special sizes: prices are to be intended for one side

Installation on quadrant shower tray 75x75 radius 38 cm

supplementi supplements

| Profilo di compensazione 3 cm Extension profile 3 cm | Sigillante SPARTAN® Sealant SPARTAN® |
|--|--------------------------------------|
| 35A010200 €  | 36B010010 €                          |

Approfondimenti Insights



|  |     |
|--|-----|
| Indice Index                           | 3   |
| Legenda simboli Icons legend           | 11  |
| Profili - Vetri Profiles - Glasses     | 21  |
| Ricambi Spare parts                    | 406 |
| Profili speciali Special profiles      | 434 |
| Schede rilievo misure Measurement form | 444 |

|                                  |                                    |        |          |   |       |      |      |            |      |             |             |          |            |
|----------------------------------|------------------------------------|--------|----------|---|-------|------|------|------------|------|-------------|-------------|----------|------------|
| 05                               | 11                                 | 12     | 16       | 24  | 25    | 26   | 27   | 28         | 29   | 30          | 31          | 32       | 34         |
| acrilico satin                   | flack                              | reflex | satinato | nigol   | flute | wave | alon | fumè brown | fumè | trasparente | extrachiaro | cincillà | stampato C |
| origin                           | abitat                             |        |          | vogue   |       |      |      |            |      |             |             |          |            |
| 20 RAL9010 / 59 Nero / 60 Bianco | 27 Tcrom® / 21 Tinox® / 22 Tbronz® |        |          | 61 Orosatinato / 62 Ororosa / 63 Cromonero / Colori |       |      |      |            |      |             |             |          |            |

# Dado Maxi

Parete doccia semicircolare con doppia porta scorrevole  
Quadrant shower enclosure with double sliding door



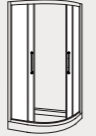













incluso

included

disponibile



available



installazioni installations

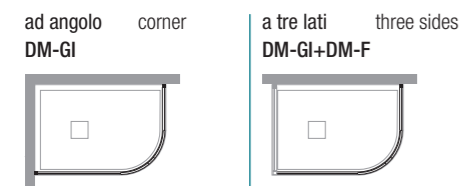

informazioni informations

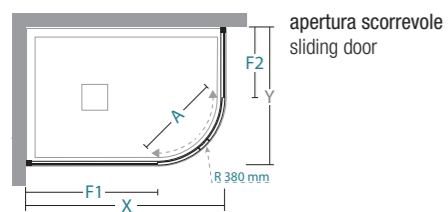

| X      | Y     | A  | F1 | F2 |  |  |  |  |  |
|--------|-------|----|----|----|--|--|--|--|--|
| 87-90  | 67-70 | 43 | 48 | 28 |  |  |  |  |  |
| 97-100 | 77-80 | 43 | 58 | 38 |  |  |  |  |  |

X/Y lunghezza parete doccia\ shower wall length  
A spazio d'entrata\ entrance space  
F lunghezza lato fisso\ fixed side length

# DM-GI38

INSTALLAZIONE AD ANGOLO O A TRE LATI  
CORNER OR THREE SIDES INSTALLATION

Misure standard Standard sizes

| Codice Code | estensibilità extension | Finiture profili Profiles finishing | 30 |
|-------------|-------------------------|-------------------------------------|----|
| 11T020001   | 67-70/87-90             | origin<br>abitat<br>vogue           |    |
| 11T020002   | 77-80/97-100            | origin<br>abitat<br>vogue           |    |

Misure speciali L Special sizes L

| Codice Code | su misura bespoke | Finiture profili Profiles finishing | 30 |
|-------------|-------------------|-------------------------------------|----|
| 11T029003   | 56 < L < 66       | origin<br>abitat<br>vogue           |    |
| 11T029003   | Standard 67-70    | origin<br>abitat<br>vogue           |    |
| 11T029003   | 71 < L < 76       | origin<br>abitat<br>vogue           |    |
| 11T029003   | Standard 77-80    | origin<br>abitat<br>vogue           |    |
| 11T029003   | 81 < L < 86       | origin<br>abitat<br>vogue           |    |
| 11T029003   | Standard 87-90    | origin<br>abitat<br>vogue           |    |
| 11T029003   | 91 < L < 96       | origin<br>abitat<br>vogue           |    |
| 11T029003   | Standard 97-100   | origin<br>abitat<br>vogue           |    |
| 11T029003   | 101 < L < 120     | origin<br>abitat<br>vogue           |    |

attenzione warning

Il prezzo della L speciale va trovato nella tabella Misure speciali L in base alla L della parete doccia  
Special price for L is to be found in Special sizes L as per L needed size

Il prezzo delle misure speciali è inteso per lato  
Special sizes: prices are to be intended for one side

Installazione su piatto doccia semicircolare raggio 38 cm  
Installation on quadrant shower tray radius 38 cm

| Misure speciali Special size | Disponibilità Availability |
|------------------------------|----------------------------|
| L min 56 cm<br>L max 120 cm  | STOCK Tcrom®               |

supplementi supplements

| Profilo di compensazione 3 cm Extension profile 3 cm | Sigillante SPARTAN® Sealant SPARTAN® |
|--|--------------------------------------|
| 35A010200 €  | 36B010010 €                          |

Approfondimenti Insights



|  |     |
|--|-----|
| Indice Index                           | 3   |
| Legenda simboli Icons legend           | 11  |
| Profili - Vetri Profiles - Glasses     | 21  |
| Ricambi Spare parts                    | 406 |
| Profili speciali Special profiles      | 434 |
| Schede rilievo misure Measurement form | 444 |

| 05                               | 11                                 | 12     | 16       | 24  | 25    | 26   | 27   | 28         | 29   | 30          | 31           | 32       | 34         |
|----------------------------------|------------------------------------|--------|----------|---|-------|------|------|------------|------|-------------|--------------|----------|------------|
| acrilico satin                   | flack                              | reflex | satinato | nigol   | flute | wave | alon | fumè brown | fumè | trasparente | extrachiario | cincillà | stampato C |
| origin                           | abitat                             |        |          | vogue   |       |      |      |            |      |             |              |          |            |
| 20 RAL9010 / 59 Nero / 60 Bianco | 27 Tcrom® / 21 Tinox® / 22 Tbronz® |        |          | 61 Orosatinato / 62 Ororosa / 63 Cromonero / Colori |       |      |      |            |      |             |              |          |            |

# Dado Maxi

Parete doccia fissa di profondità  
Fixed panel



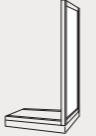











incluso      included













disponibile      available





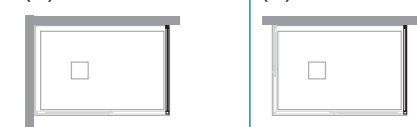

installazioni      installations  
ad angolo    corner  
(\*)      a tre lati    three sides  
(\*)

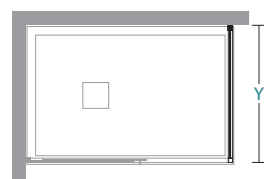

informazioni      informations



| Y      |  |  |  |  |  |  |  |  |  |  |  |
|--------|--|--|--|--|--|--|--|--|--|---|---|
| 66-72  |  |  |  |  |  |  |  |  |  | 1   | 25  |
| 71-77  |  |  |  |  |  |  |  |  |  | 1   | 27  |
| 76-82  |  |  |  |  |  |  |  |  |  | 1   | 28  |
| 81-87  |  |  |  |  |  |  |  |  |  | 1   | 30  |
| 86-92  |  |  |  |  |  |  |  |  |  | 1   | 31  |
| 96-102 |  |  |  |  |  |  |  |  |  | 1   | 35  |

Y      lunghezza parete doccia \ shower wall length

# DM-F

INSTALLAZIONE AD ANGOLO O A TRE LATI  
CORNER OR THREE SIDES INSTALLATION

## Misure standard

| Codice<br>Code | estensibilità<br>extension | Finiture profili<br>Profiles finishing | 30 | 32 | 29 | 28 | 11 |
|----------------|----------------------------|--|----|----|----|----|----|
| 11F100070      | 66-72                      | origin                                 |    |    |    |    |    |
|                |                            | abitat                                 |    |    |    |    |    |
|                |                            | vogue                                  |    |    |    |    |    |
| 11F100075      | 71-77                      | origin                                 |    |    |    |    |    |
|                |                            | abitat                                 |    |    |    |    |    |
|                |                            | vogue                                  |    |    |    |    |    |
| 11F100080      | 76-82                      | origin                                 |    |    |    |    |    |
|                |                            | abitat                                 |    |    |    |    |    |
|                |                            | vogue                                  |    |    |    |    |    |
| 11F100085      | 81-87                      | origin                                 |    |    |    |    |    |
|                |                            | abitat                                 |    |    |    |    |    |
|                |                            | vogue                                  |    |    |    |    |    |
| 11F100090      | 86-92                      | origin                                 |    |    |    |    |    |
|                |                            | abitat                                 |    |    |    |    |    |
|                |                            | vogue                                  |    |    |    |    |    |
| 11F100100      | 96-102                     | origin                                 |    |    |    |    |    |
|                |                            | abitat                                 |    |    |    |    |    |
|                |                            | vogue                                  |    |    |    |    |    |

## Misure speciali L / H

| Codice<br>Code | su misura<br>bespoke | Finiture profili<br>Profiles finishing | 30 | 32 | 16 | 29 | 28 |
|----------------|----------------------|--|----|----|----|----|----|
| 11F109001      | 14 < L < 60          | origin                                 |    |    |    |    |    |
|                |                      | abitat                                 |    |    |    |    |    |
|                |                      | vogue                                  |    |    |    |    |    |
| 11F109001      | 61 < L < 100         | origin                                 |    |    |    |    |    |
|                |                      | abitat                                 |    |    |    |    |    |
|                |                      | vogue                                  |    |    |    |    |    |
| 11F109001      | 101 < L < 140        | origin                                 |    |    |    |    |    |
|                |                      | abitat                                 |    |    |    |    |    |
|                |                      | vogue                                  |    |    |    |    |    |
| 11F109001      | 141 < L < 160        | origin                                 |    |    |    |    |    |
|                |                      | abitat                                 |    |    |    |    |    |
|                |                      | vogue                                  |    |    |    |    |    |

## Speciali - solo profili

| Codice<br>Code | su misura<br>bespoke | Finiture profili<br>Profiles finishing |  |
|----------------|----------------------|--|--|
| 11F109003      | L < 14               | origin                                 |  |
|                |                      | abitat                                 |  |
|                |                      | vogue                                  |  |

## attenzione

Il prezzo della H speciale va trovato nella tabella Misure speciali L / H in base alla L della parete doccia

Special price for H is to be found in Special sizes L / H as per L needed size

## warning

(\*) DM-F è abbinabile a tutte le pareti doccia DM- PSC, PSC2, ASC, PSO, PSM, PGI, PSA2, T55, T38, AR55, GI38

(\*) DM-F to match all shower enclosures DM- PSC, PSC2, ASC, PSO, PSM, PGI, PSA2, T55, T38, AR55, GI38

## Misure speciali

| H | max | 210 cm |
|---|-----|--------|
| L | min | 14 cm  |
| L | max | 160 cm |

## Disponibilità

Availibility      ■ STOCK      Tcrom®

## supplementi

Profilo di compensazione 3 cm  
Extension profile 3 cm

## supplements

Sigillante SPARTAN®  
Sealant SPARTAN®

35A010200      €

36B010010      €

## Approfondimenti



|   |     |
|---|-----|
| Indice<br>Index                           | 3   |
| Legenda simboli<br>Icons legend           | 11  |
| Profili - Vetri<br>Profiles - Glasses     | 21  |
| Ricambi<br>Spare parts                    | 406 |
| Profili speciali<br>Special profiles      | 434 |
| Schede rilievo misure<br>Measurement form | 444 |

|                |       |        |          |       |       |      |      |            |      |             |              |          |            |
|----------------|-------|--------|----------|-------|-------|------|------|------------|------|-------------|--------------|----------|------------|
| 05             | 11    | 12     | 16       | 24    | 25    | 26   | 27   | 28         | 29   | 30          | 31           | 32       | 34         |
| acrilico satin | flack | reflex | satinato | nigol | flute | wave | alon | fumè brown | fumè | trasparente | extrachiario | cincillà | stampato C |

| origin                           | abitat                             | vogue   |
|----------------------------------|------------------------------------|---|
| 20 RAL9010 / 59 Nero / 60 Bianco | 27 Tcrom® / 21 Tinox® / 22 Tbronz® | 61 Orosatinato / 62 Ororosa / 63 Cromonero / Colori |



Porta scorrevole installazione ad angolo  
 profilo Tbrill® / vetro Trasparente  
 Piatto doccia AMBROGIO

Sliding door corner installation  
 Tbrill® profile / Transparent glass  
 Shower tray AMBROGIO

## DINO

Con la bellezza dei suoi profili e la tecnica dello scorrimento anta questa serie dimostra un'elevata capacità di esaltazione del design minimalista e sostenibile. Disegnata dal designer Idelfonso Colombo, Dino è un progetto che coniuga innovazione, ricerca e design creativo con la qualità del prodotto made in Italy

Beautiful profiles and a state-of-the-art door sliding system make this series a true example of minimalism and sustainable design. Designed by Idelfonso Colombo, an Italian designer, Dino is a project that unites innovation, research and creativity with the quality of made in Italy products



01



02



03



04

01 gruppo di scorrimento regolabile con doppio cuscinetto a sfera | 02 sistema di sgancio rapido applicato direttamente all'anta | 03 particolare di giunzione a 45° del modello angolo | 04 elemento di raccordo per fregio rettangolare a dentello |

01 adjustable sliding block with twin wheels | 02 quick release system | 03 detail of the 45° corner connection part | 04 cover plate for rectangular frieze |



### CARATTERISTICHE FEATURES

- H cm 200** ALTEZZA PARETI DOCCIA  
SHOWER DOOR HEIGHT
- 4mm** SPESSORE LASTRA  
GLASS DEPTH
- REV** REVERSIBILE  
REVERSIBLE

### INFO TECNICHE TECHNICAL INFORMATION

- REGOLAZIONE FUORI SQUADRO**  
OFF-SQUARE REGULATION
- EST cm** ESTENSIBILITÀ 3/6  
EXSTENSIBILITY 3/6
- SGANCIO RAPIDO**  
QUICK-RELEASE
- PROFILO MANIGLIA**  
HANDLE PROFILE
- PROFILO MAGNETICO**  
MAGNETIC PROFILE
- MISURE SPECIALI**  
SPECIAL SIZES

### Finiture profili

#### ORIGIN

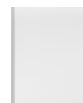

20  
RAL 9010

### Profiles finishing

#### ABITAT



24  
Tbrill®

### Vetri



30  
Trasparente



34  
Stampato C

### Glasses

### installazioni previste allowed installations

#### in nicchia

DN-PSC

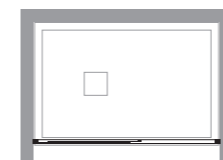

DN-PSC2

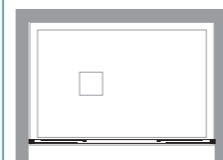

#### niche

DN-PSO

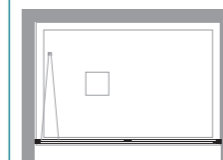

DN-PGI

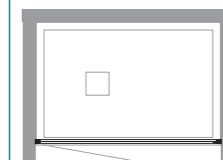

DN-PSA2

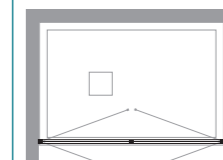

#### ad angolo

DN-PSC+DN-F

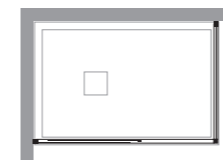

DN-PSC2+DN-F

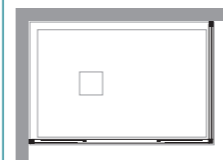

#### corner

DN-ASC+DN-ASC

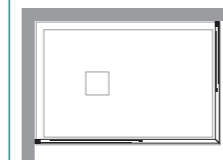

DN-PSO+DN-F

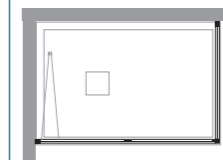

DN-PGI+DN-F

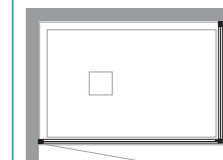

DN-PSA2+DN-F

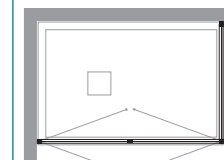

#### a tre lati

DN-PSC+2xDN-F



DN-PSC2+2xDN-F

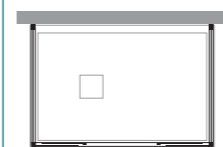

#### three sides

2xDN-ASC+DN-F



DN-PSO+2xDN-F (\*)

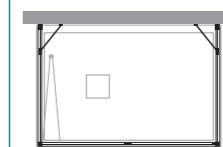

DN-PGI+2xDN-F (\*)

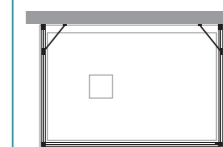

DN-PSA2+2xDN-F (\*)

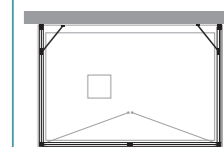

#### semicircolari

DN-T55

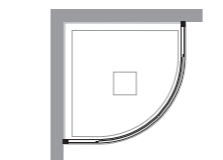

DN-T55+DN-F

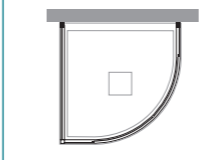

#### quadrant

DN-T38/GI38

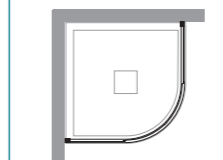

DN-T38/GI38+DN-F

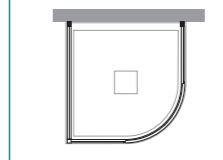

#### profili

#### profiles

per/for **DN: ASC-T55-T38-GI38**

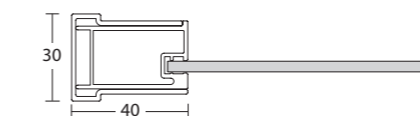

profilo a muro 1401 + schienale 1402

wall profile 1401 + vertical profile 1402

per/for **DN: PSC-PSC2-PSO-PGI-PSA2**

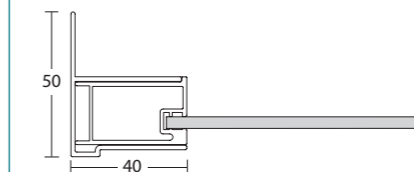

profilo a muro 1406 + schienale 1402

wall profile 1406 + vertical profile 1402

#### importante

#### important

ordini per pareti doccia speciali senza relativo disegno  
**NON** vengono prodotti

orders for special shower walls without related design are  
**NOT** produced

coppia di sostegni obbligatori per installazioni a tre lati (\*)

mandatory of couple of supports for three sides installation (\*)



**Misure standard** Standard sizes

| Codice Code | estensibilità extension | Finiture profili Profiles finishing | 30 | 34 |
|-------------|-------------------------|-------------------------------------|----|----|
| 13P010100   | 96-102                  | RAL 9010<br>Tbrill®                 | ■  |    |
| 13P010110   | 106-112                 | RAL 9010<br>Tbrill®                 | ■  |    |
| 13P010120   | 116-122                 | RAL 9010<br>Tbrill®                 | ■  | ■  |
| 13P010130   | 126-132                 | RAL 9010<br>Tbrill®                 | ■  |    |
| 13P010140   | 136-142                 | RAL 9010<br>Tbrill®                 | ■  |    |
| 13P010150   | 146-152                 | RAL 9010<br>Tbrill®                 | ■  |    |
| 13P010160   | 156-162                 | RAL 9010<br>Tbrill®                 | ■  |    |

**Misure speciali L / H** Special sizes L / H

| Codice Code | su misura bespoke | Finiture profili Profiles finishing | 30 | 34 |
|-------------|-------------------|-------------------------------------|----|----|
| 13P019001   | 90 < L < 100      | RAL 9010<br>Tbrill®                 |    |    |
| 13P019001   | 101 < L < 120     | RAL 9010<br>Tbrill®                 |    |    |
| 13P019001   | 121 < L < 140     | RAL 9010<br>Tbrill®                 |    |    |
| 13P019001   | 141 < L < 170     | RAL 9010<br>Tbrill®                 |    |    |

**incluso** included

**disponibile** available

installazioni

in nicchia niche  
**DN-PSC**

ad angolo corner  
**DN-PSC+DN-F**

a tre lati three sides  
**DN-PSC+DN-F+DN-F**

informazioni

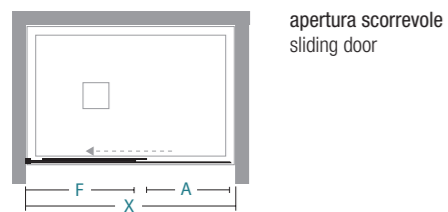

informations

apertura scorrevole  
sliding door

|  | X       | A  | F  |  |  |  |  |  |  |   |    |
|--|---------|----|----|--|--|--|--|--|--|---|----|
|  | 96-102  | 41 | 48 |  |  |  |  |  |  | 1 | 28 |
|  | 106-112 | 46 | 53 |  |  |  |  |  |  | 1 | 31 |
|  | 116-122 | 51 | 58 |  |  |  |  |  |  | 1 | 33 |
|  | 126-132 | 56 | 63 |  |  |  |  |  |  | 2 | 36 |
|  | 136-142 | 61 | 68 |  |  |  |  |  |  | 2 | 39 |
|  | 146-152 | 61 | 78 |  |  |  |  |  |  | 2 | 41 |
|  | 156-162 | 61 | 88 |  |  |  |  |  |  | 2 | 44 |

X lunghezza parete doccia\ shower wall length  
A spazio d'entrata\ entrance space  
F lunghezza lato fisso\ fixed side length

attenzione

Il prezzo della H speciale va trovato nella tabella Misure speciali L / H in base alla L della parete doccia

Special price for H is to be found in Special sizes L / H as per L needed size

warning

Misure speciali  
Special size

| H   | L      | L | Disponibilità Availability | Finiture profili Profiles finishing |
|-----|--------|---|----------------------------|-------------------------------------|
| max | 200 cm |   | ■ STOCK                    | Tbrill®                             |
| min | 90 cm  |   |                            |                                     |
| max | 170 cm |   |                            |                                     |

supplementi

| Profilo di compensazione 3 cm<br>Extension profile 3 cm | Set trattamento Neverdrop®<br>set Neverdrop® | Sigillante SPARTAN®<br>Sealant SPARTAN® |
|---|--|---|
| 35A080200   | 36A010004                                    | 36B010010                               |

| 05             | 11    | 12     | 16       | 24    | 25    | 26         | 27   | 28         | 29   | 30          | 31          | 32       | 34         |
|----------------|-------|--------|----------|-------|-------|------------|------|------------|------|-------------|-------------|----------|------------|
| acrilico satin | flack | reflex | satinato | nigol | flute | wave       | alou | fumè brown | fumè | trasparente | extrachiaro | cincillà | stampato C |
| origin         |       |        |          |       |       | abitat     |      |            |      |             |             |          |            |
| 20 RAL9010     |       |        |          |       |       | 24 Tbrill® |      |            |      |             |             |          |            |

Approfondimenti  
Insights



|  |     |
|--|-----|
| Indice Index                           | 3   |
| Legenda simboli Icons legend           | 11  |
| Profili - Vetri Profiles - Glasses     | 21  |
| Ricambi Spare parts                    | 406 |
| Profili speciali Special profiles      | 434 |
| Schede rilievo misure Measurement form | 444 |

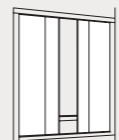
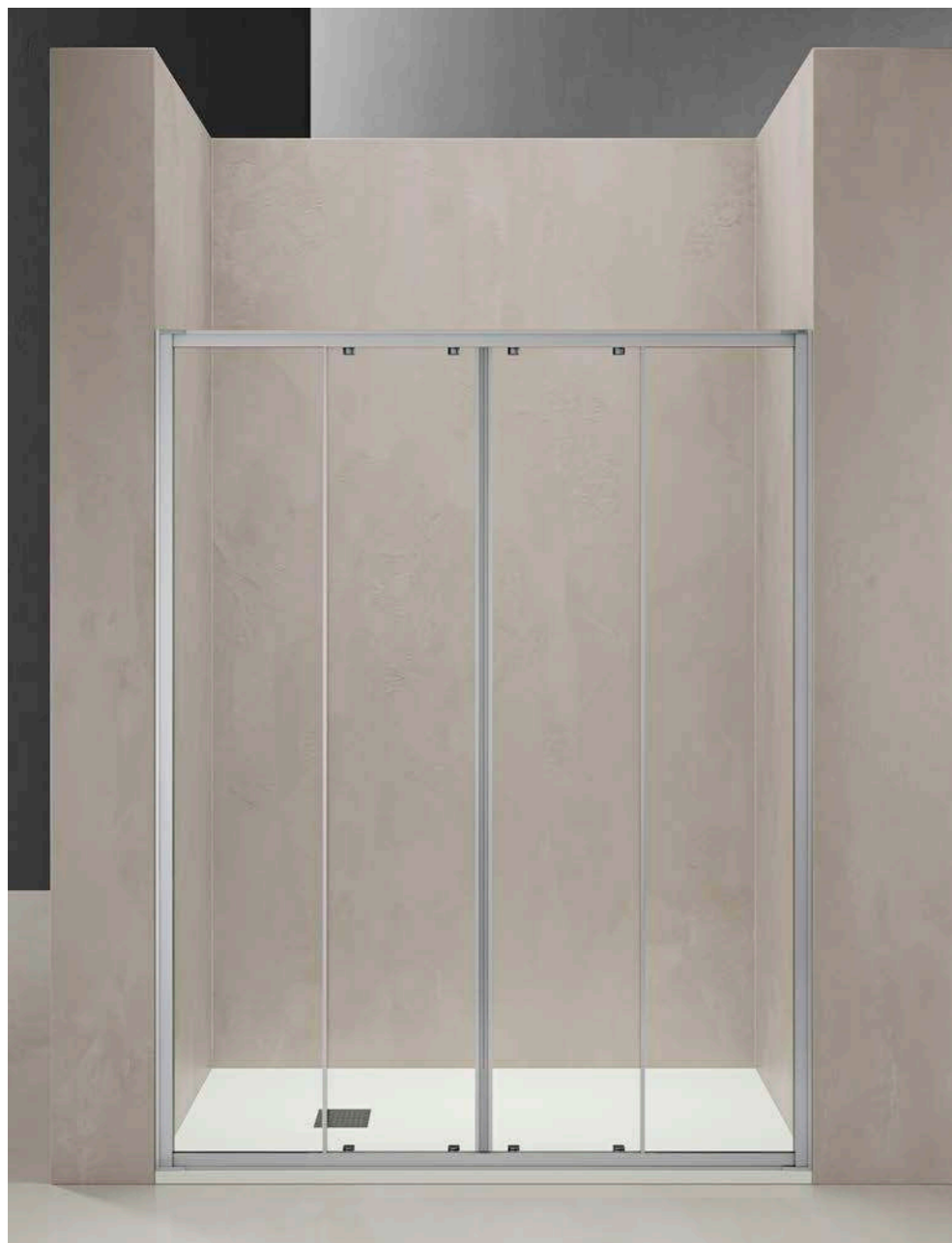

incluso

included



disponibile

available



## installazioni

in nicchia niche  
DN-PSC2

## installations

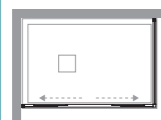
ad angolo corner  
DN-PSC2+DN-Fa tre lati three sides  
DN-PSC2+DN-F+DN-F

## informazioni

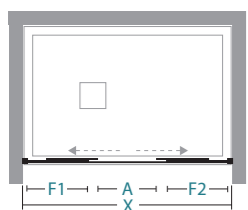
apertura scorrevole  
sliding door

## informations

| X       | A  | F1/F2 |  |  |  |  |  |   |    |
|---------|----|-------|--|--|--|--|--|---|----|
| 116-122 | 49 | 30,5  |  |  |  |  |  | 2 | 37 |
| 126-132 | 54 | 33    |  |  |  |  |  | 2 | 39 |
| 136-142 | 59 | 35,5  |  |  |  |  |  | 2 | 42 |
| 146-152 | 64 | 38    |  |  |  |  |  | 2 | 45 |
| 156-162 | 69 | 40,5  |  |  |  |  |  | 2 | 47 |
| 166-172 | 74 | 43    |  |  |  |  |  | 2 | 49 |
| 176-182 | 79 | 45,5  |  |  |  |  |  | 2 | 52 |

X lunghezza parete doccia\ shower wall length  
A spazio d'entrata\ entrance space  
F1/F2 lunghezza lato fisso\ fixed side length

## Misure standard

## Standard sizes

| Codice<br>Code | estensibilità<br>extension | Finiture profili<br>Profiles finishing | 30 | 34 |
|----------------|----------------------------|--|----|----|
| 13P020120      | 116-122                    | RAL 9010<br>Tbrill®                    |    |    |
| 13P020130      | 126-132                    | RAL 9010<br>Tbrill®                    |    |    |
| 13P020140      | 136-142                    | RAL 9010<br>Tbrill®                    |    |    |
| 13P020150      | 146-152                    | RAL 9010<br>Tbrill®                    |    |    |
| 13P020160      | 156-162                    | RAL 9010<br>Tbrill®                    |    |    |
| 13P020170      | 166-172                    | RAL 9010<br>Tbrill®                    |    |    |
| 13P020180      | 176-182                    | RAL 9010<br>Tbrill®                    |    |    |

## Misure speciali L / H

## Special sizes L / H

| Codice<br>Code | su misura<br>bespoke | Finiture profili<br>Profiles finishing | 30 | 34 |
|----------------|----------------------|--|----|----|
| 13P029001      | 100 < L < 120        | RAL 9010<br>Tbrill®                    |    |    |
| 13P029001      | 121 < L < 140        | RAL 9010<br>Tbrill®                    |    |    |
| 13P029001      | 141 < L < 160        | RAL 9010<br>Tbrill®                    |    |    |
| 13P029001      | 161 < L < 180        | RAL 9010<br>Tbrill®                    |    |    |

## attenzione

Il prezzo della H speciale va trovato nella tabella Misure speciali L / H in base alla L della parete doccia

Special price for H is to be found in Special sizes L / H as per L needed size

## warning

Misure speciali  
Special size

|   |     |        |
|---|-----|--------|
| H | max | 200 cm |
| L | min | 100 cm |
| L | max | 180 cm |

## supplementi

## supplements

| Profilo di compensazione 3 cm<br>Extension profile 3 cm | Set trattamento Neverdrop®<br>set Neverdrop® | Sigillante SPARTAN®<br>Sealant SPARTAN® |
|---|--|---|
| 35A080200   | 36A010004                                    | 36B010010                               |
| €   | €  | €                                       |

| 05                      | 11     | 12     | 16       | 24    | 25    | 26         | 27   | 28         | 29   | 30          | 31          | 32       | 34         |
|-------------------------|--------|--------|----------|-------|-------|------------|------|------------|------|-------------|-------------|----------|------------|
| acrilico satin<br>flack | reflex | reflex | satinato | nigol | flute | wave       | alou | fumè brown | fumè | trasparente | extrachiaro | cincillà | stampato C |
| origin                  |        |        |          |       |       | abitat     |      |            |      |             |             |          |            |
| 20 RAL9010              |        |        |          |       |       | 24 Tbrill® |      |            |      |             |             |          |            |

Approfondimenti  
Insights

|   |     |
|---|-----|
| Indice<br>Index                           | 3   |
| Legenda simboli<br>Icons legend           | 11  |
| Profili - Vetri<br>Profiles - Glasses     | 21  |
| Ricambi<br>Spare parts                    | 406 |
| Profili speciali<br>Special profiles      | 434 |
| Schede rilievo misure<br>Measurement form | 444 |

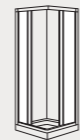

incluso

included



disponibile

available



## installazioni

ad angolo corner  
DN-ASC+DN-ASC

## installations

a tre lati three sides  
DN-ASC+DN-ASC+DN-F

## informazioni

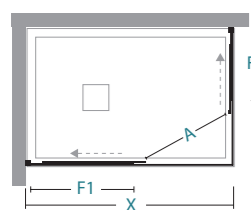
apertura scorrevole  
sliding door

## informations

| X/Y     | 67-70 | 72-75 | 77-80 | 82-85 | 87-90 | 97-120 | F1/F2 |   |    |
|---------|-------|-------|-------|-------|-------|--------|-------|---|----|
| 67-70   | A=38  |       |       |       |       |        | 33    | 1 | 19 |
| 72-75   | A=40  | A=41  |       |       |       |        | 35    | 1 | 20 |
| 77-80   | A=42  | A=43  | A=45  |       |       |        | 38    | 1 | 22 |
| 82-85   | A=44  | A=45  | A=47  | A=49  |       |        | 40    | 1 | 23 |
| 87-90   | A=46  | A=47  | A=49  | A=51  | A=52  |        | 43    | 1 | 24 |
| 97-100  | A=49  | A=50  | A=52  | A=53  | A=55  | A=58   | 48    | 1 | 28 |
| 117-120 | A=49  | A=50  | A=52  | A=53  | A=55  | A=58   | 68    | 1 | 33 |

X / Y lunghezza parete doccia \ shower wall length

A spazio d'entrata \ entrance space

F1 / F2 lunghezza lato fisso \ fixed side length

## Misure standard

## Standard sizes

| Codice<br>Code | estensibilità<br>extension | Finiture profili<br>Profiles finishing | 30 | 34 |
|----------------|----------------------------|--|----|----|
| 13A010070      | 67-70                      | RAL 9010<br>Tbrill®                    |    |    |
| 13A010075      | 72-75                      | RAL 9010<br>Tbrill®                    |    |    |
| 13A010080      | 77-80                      | RAL 9010<br>Tbrill®                    |    |    |
| 13A010085      | 82-85                      | RAL 9010<br>Tbrill®                    |    |    |
| 13A010090      | 87-90                      | RAL 9010<br>Tbrill®                    |    |    |
| 13A010100      | 97-100                     | RAL 9010<br>Tbrill®                    |    |    |
| 13A010120      | 117-120                    | RAL 9010<br>Tbrill®                    |    |    |

## Misure speciali L / H

## Special sizes L / H

| Codice<br>Code | su misura<br>bespoke | Finiture profili<br>Profiles finishing | 30 | 34 |
|----------------|----------------------|--|----|----|
| 13A019001      | 45 < L < 60          | RAL 9010<br>Tbrill®                    |    |    |
| 13A019001      | 61 < L < 90          | RAL 9010<br>Tbrill®                    |    |    |
| 13A019001      | 91 < L < 120         | RAL 9010<br>Tbrill®                    |    |    |

## attenzione

Il prezzo della H speciale va trovato nella tabella Misure speciali L / H in base alla L della parete doccia

Special price for H is to be found in Special sizes L / H as per L needed size

## warning

Il prezzo è inteso per lato

Prices are to be intended for one side

Misure speciali  
Special size

|   |     |        |
|---|-----|--------|
| H | max | 200 cm |
| L | min | 45 cm  |
| L | max | 120 cm |

Disponibilità  
Availability

|  |       |         |
|--|-------|---------|
|  | STOCK | RAL9010 |
|  | STOCK | Tbrill® |

## supplementi

Profilo di compensazione 3 cm  
Extension profile 3 cm

€

05 acrilico satin  
11 flack

origin  
20 RAL9010

## supplements

Set trattamento Neverdrop®  
set Neverdrop®

€

12 reflex  
16 satinato  
24 nigol

abitat  
24 Tbrill®

Sigillante SPARTAN®  
Sealant SPARTAN®

€

25 flute

26 wave

27 aion

28 fumè brown

29 fumè

30 trasparente

31 extrachiaro

32 cincillà

34 stampato C

Approfondimenti  
Insights

|   |     |
|---|-----|
| Indice<br>Index                           | 3   |
| Legenda simboli<br>Icons legend           | 11  |
| Profili - Vetri<br>Profiles - Glasses     | 21  |
| Ricambi<br>Spare parts                    | 406 |
| Profili speciali<br>Special profiles      | 434 |
| Schede rilievo misure<br>Measurement form | 444 |

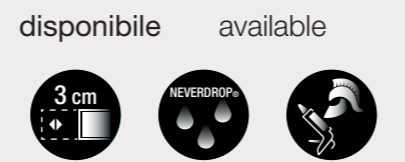
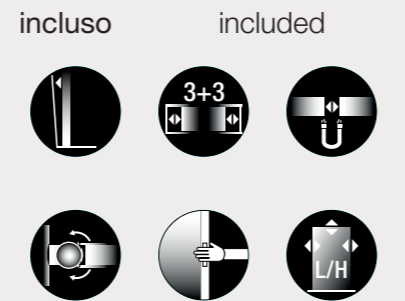
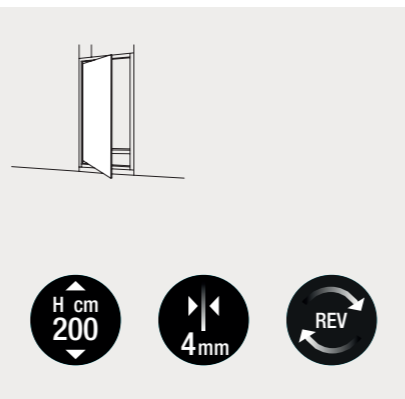

installazioni

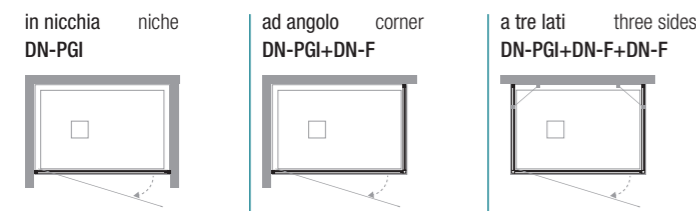

informazioni

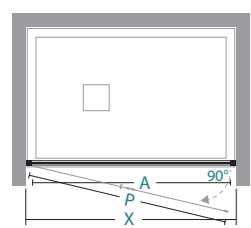

**X** lunghezza parete doccia\ shower wall length  
**A** spazio d'entrata\ entrance space  
**P** lunghezza porta\ door length  
**I** ingombro interno\ internal dimensions

installations

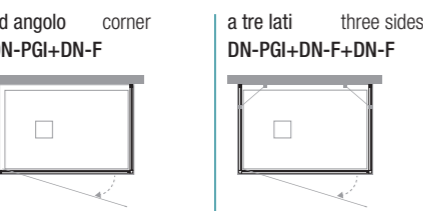

informations

apertura scorrevole  
sliding door

|        | X  | A  | P  | I |  |  |  |   |    |
|--------|----|----|----|---|--|--|--|---|----|
| 66-72  | 45 | 46 | 12 |   |  |  |  | 1 | 25 |
| 71-77  | 50 | 51 | 12 |   |  |  |  | 1 | 26 |
| 76-82  | 55 | 56 | 12 |   |  |  |  | 1 | 27 |
| 81-87  | 60 | 61 | 12 |   |  |  |  | 1 | 29 |
| 86-92  | 57 | 58 | 20 |   |  |  |  | 1 | 30 |
| 94-100 | 59 | 60 | 26 |   |  |  |  | 1 | 32 |

Misure standard

| Codice Code | estensibilità extension | Finiture profili Profiles finishing | 30 | 34 |
|-------------|-------------------------|-------------------------------------|----|----|
| 13P030070   | 66-72                   | RAL 9010<br>Tbrill®                 |    |    |
| 13P030075   | 71-77                   | RAL 9010<br>Tbrill®                 |    |    |
| 13P030080   | 76-82                   | RAL 9010<br>Tbrill®                 |    |    |
| 13P030085   | 81-87                   | RAL 9010<br>Tbrill®                 |    |    |
| 13P030090   | 86-92                   | RAL 9010<br>Tbrill®                 |    |    |
| 13P030100   | 94-100                  | RAL 9010<br>Tbrill®                 |    |    |

Standard sizes

Misure speciali L / H

| Codice Code | su misura bespoke | Finiture profili Profiles finishing | 30 | 34 |
|-------------|-------------------|-------------------------------------|----|----|
| 13P039001   | 50 < L < 60       | RAL 9010<br>Tbrill®                 |    |    |
| 13P039001   | 61 < L < 80       | RAL 9010<br>Tbrill®                 |    |    |
| 13P039001   | 81 < L < 100      | RAL 9010<br>Tbrill®                 |    |    |

Special sizes L / H

attenzione

Il prezzo della H speciale va trovato nella tabella Misure speciali L / H in base alla L della parete doccia

Special price for H is to be found in Special sizes L / H as per L needed size

warning

Misure speciali Special size

|   |     |        |
|---|-----|--------|
| H | max | 200 cm |
| L | min | 50 cm  |
| L | max | 100 cm |

Disponibilità Availability

STOCK Tbrill®

supplementi

Profilo di compensazione 3 cm  
Extension profile 3 cm

Set trattamento Neverdrop®  
set Neverdrop®

Sigillante SPARTAN®  
Sealant SPARTAN®

Supporto regolabile 100 cm  
Adjustable bar 100 cm

|           |           |           |           |
|-----------|-----------|-----------|-----------|
| 35A080200 | 36A010004 | 36B010010 | 36S117002 |
| €         | €         | €         | €         |

| 05             | 11    | 12     | 16       | 24    | 25    | 26         | 27   | 28         | 29   | 30          | 31          | 32       | 34         |
|----------------|-------|--------|----------|-------|-------|------------|------|------------|------|-------------|-------------|----------|------------|
| acrilico satin | flack | reflex | satinato | nigol | flute | wave       | alon | fumè brown | fumè | trasparente | extrachiaro | cincillà | stampato C |
| origin         |       |        |          |       |       | abitat     |      |            |      |             |             |          |            |
| 20 RAL9010     |       |        |          |       |       | 24 Tbrill® |      |            |      |             |             |          |            |

Approfondimenti Insights



|  |     |
|--|-----|
| Indice Index                           | 3   |
| Legenda simboli Icons legend           | 11  |
| Profili - Vetri Profiles - Glasses     | 21  |
| Ricambi Spare parts                    | 406 |
| Profili speciali Special profiles      | 434 |
| Schede rilievo misure Measurement form | 444 |



incluso included

disponibile available

installazioni

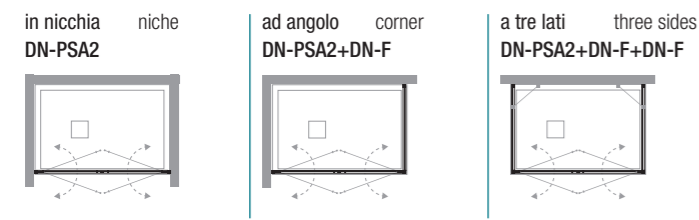

informazioni

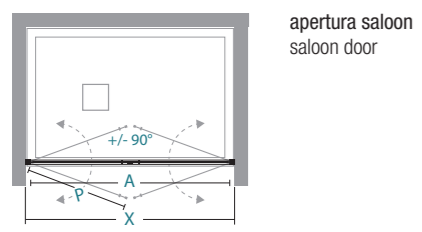

X lunghezza parete doccia \ shower wall length  
A spazio d'entrata \ entrance space  
P lunghezza porta \ door length

installations

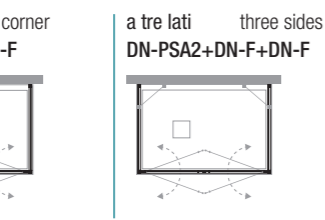

informations

|         | X  | A    | P |  |  |  |  |  |  |   |    |
|---------|----|------|---|--|--|--|--|--|--|---|----|
| 66-72   | 46 | 22   |   |  |  |  |  |  |  | 1 | 25 |
| 71-77   | 51 | 24,5 |   |  |  |  |  |  |  | 1 | 26 |
| 76-82   | 56 | 27   |   |  |  |  |  |  |  | 1 | 27 |
| 81-87   | 61 | 28,5 |   |  |  |  |  |  |  | 1 | 28 |
| 86-92   | 66 | 32   |   |  |  |  |  |  |  | 1 | 30 |
| 96-102  | 76 | 37   |   |  |  |  |  |  |  | 1 | 32 |
| 116-122 | 76 | 37   |   |  |  |  |  |  |  | 1 | 37 |

| Misure standard |                            |  | Standard sizes |    |
|-----------------|----------------------------|--|----------------|----|
| Codice<br>Code  | estensibilità<br>extension | Finiture profili<br>Profiles finishing | 30             | 34 |
| 13P050070       | 66-72                      | RAL 9010<br>Tbrill®                    |                |    |
| 13P050075       | 71-77                      | RAL 9010<br>Tbrill®                    |                |    |
| 13P050080       | 76-82                      | RAL 9010<br>Tbrill®                    |                |    |
| 13P050085       | 81-87                      | RAL 9010<br>Tbrill®                    |                |    |
| 13P050090       | 86-92                      | RAL 9010<br>Tbrill®                    |                |    |
| 13P050100       | 96-102                     | RAL 9010<br>Tbrill®                    |                |    |
| 13P050120       | 116-122                    | RAL 9010<br>Tbrill®                    |                |    |

| Misure speciali L / H |                      |  | Special sizes L / H |    |
|-----------------------|----------------------|--|---------------------|----|
| Codice<br>Code        | su misura<br>bespoke | Finiture profili<br>Profiles finishing | 30                  | 34 |
| 13P059001             | 45 < L < 60          | RAL 9010<br>Tbrill®                    |                     |    |
| 13P059001             | 61 < L < 90          | RAL 9010<br>Tbrill®                    |                     |    |
| 13P059001             | 91 < L < 120         | RAL 9010<br>Tbrill®                    |                     |    |

attenzione

Il prezzo della H speciale va trovato nella tabella Misure speciali L / H in base alla L della parete doccia  
Special price for H is to be found in Special sizes L / H as per L needed size

warning

Misure speciali  
Special size

|       |        |  |       |         |
|-------|--------|--|-------|---------|
| H max | 200 cm |  | STOCK | Tbrill® |
| L min | 45 cm  |  |       |         |
| L max | 120 cm |  |       |         |

supplementi

| Profilo di compensazione 3 cm<br>Extension profile 3 cm | Set trattamento Neverdrop®<br>set Neverdrop® | Sigillante SPARTAN®<br>Sealant SPARTAN® | Supporto regolabile 100 cm<br>Adjustable bar 100 cm |
|---|--|---|---|
| 35A080200 €   | 36A010004 €                                  | 36B010010 €                             | 36S117002 €   |

| 05             | 11    | 12     | 16       | 24    | 25    | 26         | 27   | 28         | 29   | 30          | 31           | 32       | 34         |
|----------------|-------|--------|----------|-------|-------|------------|------|------------|------|-------------|--------------|----------|------------|
| acrilico satin | flack | reflex | satinato | nigol | flute | wave       | alon | fumè brown | fumè | trasparente | extrachiario | cincillà | stampato C |
| origin         |       |        |          |       |       | abitat     |      |            |      |             |              |          |            |
| 20 RAL9010     |       |        |          |       |       | 24 Tbrill® |      |            |      |             |              |          |            |

Approfondimenti  
Insights



|   |     |
|---|-----|
| Indice<br>Index                           | 3   |
| Legenda simboli<br>Icons legend           | 11  |
| Profili - Vetri<br>Profiles - Glasses     | 21  |
| Ricambi<br>Spare parts                    | 406 |
| Profili speciali<br>Special profiles      | 434 |
| Schede rilievo misure<br>Measurement form | 444 |



H cm  
200

4mm

REV

incluso      included

3+3

L/H

disponibile      available

3 cm

NEVERDROP®

installazioni

in nicchia    niche  
DN-PSO



installations

ad angolo    corner  
DN-PSO+DN-F



a tre lati    three sides  
DN-PSO+DN-F+DN-F

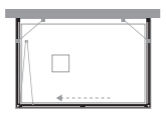

informazioni

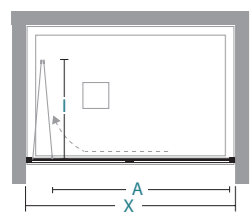

informations

apertura scorrevole  
sliding door

|        | X  | A    | I |  |  |  |  |  |   |    |
|--------|----|------|---|--|--|--|--|--|---|----|
| 66-72  | 52 | 32   |   |  |  |  |  |  | 1 | 22 |
| 71-77  | 57 | 34,5 |   |  |  |  |  |  | 1 | 24 |
| 76-82  | 62 | 37   |   |  |  |  |  |  | 1 | 25 |
| 81-87  | 67 | 39,5 |   |  |  |  |  |  | 1 | 26 |
| 86-92  | 72 | 42   |   |  |  |  |  |  | 1 | 27 |
| 94-100 | 80 | 46   |   |  |  |  |  |  | 1 | 30 |

X lunghezza parete doccia\ shower wall length  
A spazio d'entrata\ entrance space  
I ingombro interno\ internal dimensions

## DN-PSO

INSTALLAZIONE IN NICCHIA, AD ANGOLO O A TRE LATI  
NICHE, CORNER OR THREE SIDES INSTALLATION

Misure standard

| Codice<br>Code | estensibilità<br>extension | Finiture profili<br>Profiles finishing | 30 | 34 |
|----------------|----------------------------|--|----|----|
| 13P040070      | 66-72                      | RAL 9010<br>Tbrill®                    |    |    |
| 13P040075      | 71-77                      | RAL 9010<br>Tbrill®                    |    |    |
| 13P040080      | 76-82                      | RAL 9010<br>Tbrill®                    |    |    |
| 13P040085      | 81-87                      | RAL 9010<br>Tbrill®                    |    |    |
| 13P040090      | 86-92                      | RAL 9010<br>Tbrill®                    |    |    |
| 13P040100      | 94-100                     | RAL 9010<br>Tbrill®                    |    |    |

Standard sizes

Misure speciali L / H

| Codice<br>Code | su misura<br>bespoke | Finiture profili<br>Profiles finishing | 30 | 34 |
|----------------|----------------------|--|----|----|
| 13P049001      | 50 < L < 60          | RAL 9010<br>Tbrill®                    |    |    |
| 13P049001      | 61 < L < 80          | RAL 9010<br>Tbrill®                    |    |    |
| 13P049001      | 81 < L < 100         | RAL 9010<br>Tbrill®                    |    |    |

Special sizes L / H

attenzione

Il prezzo della H speciale va trovato nella tabella Misure speciali L / H in base alla L della parete doccia

Special price for H is to be found in Special sizes L / H as per L needed size

warning

Misure speciali  
Special size

|   |     |        |
|---|-----|--------|
| H | max | 200 cm |
| L | min | 50 cm  |
| L | max | 100 cm |

Disponibilità  
Availability

■ STOCK      Tbrill®

supplementi

Profilo di compensazione 3 cm  
Extension profile 3 cm

€ 35A080200

Set trattamento Neverdrop®  
set Neverdrop®

€ 36A010004

supplements

Sigillante SPARTAN®  
Sealant SPARTAN®

€ 36B010010

Supporto regolabile 100 cm  
Adjustable bar 100 cm

€ 36S117002

| 05             | 11    | 12     | 16       | 24    | 25    | 26         | 27   | 28         | 29   | 30          | 31          | 32       | 34         |
|----------------|-------|--------|----------|-------|-------|------------|------|------------|------|-------------|-------------|----------|------------|
| acrilico satin | flack | reflex | satinato | nigol | flute | wave       | alon | fumè brown | fumè | trasparente | extrachiaro | cincillà | stampato C |
| origin         |       |        |          |       |       | abitat     |      |            |      |             |             |          |            |
| 20 RAL9010     |       |        |          |       |       | 24 Tbrill® |      |            |      |             |             |          |            |

Approfondimenti  
Insights



|   |     |
|---|-----|
| Indice<br>Index                           | 3   |
| Legenda simboli<br>Icons legend           | 11  |
| Profili - Vetri<br>Profiles - Glasses     | 21  |
| Ricambi<br>Spare parts                    | 406 |
| Profili speciali<br>Special profiles      | 434 |
| Schede rilievo misure<br>Measurement form | 444 |



incluso

included



disponibile

available



installazioni

ad angolo  
DN-T55

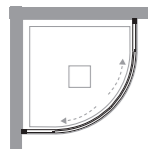

installations

a tre lati  
DN-T55+DN-F

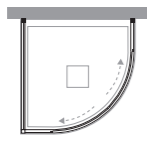

informazioni

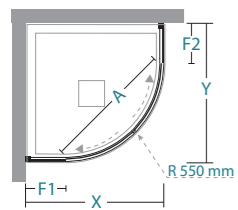

informations

apertura scorrevole  
sliding door

| X/Y   | A  | F1/F2 |  |  |  |  |  |   |    |
|-------|----|-------|--|--|--|--|--|---|----|
| 77-80 | 41 | 23    |  |  |  |  |  | 2 | 39 |
| 87-90 | 52 | 33    |  |  |  |  |  | 2 | 44 |

X / Y lunghezza parete doccia\ shower wall length  
A spazio d'entrata\ entrance space  
F1 / F2 lunghezza lato fisso\ fixed side length

## DN-T55

INSTALLAZIONE AD ANGOLO O A TRE LATI  
CORNER OR THREE SIDES INSTALLATION

Misure standard

Standard sizes

| Codice Code | estensibilità extension | Finiture profili Profiles finishing | 30 | 34 |
|-------------|-------------------------|-------------------------------------|----|----|
| 13T010080   | 77-80                   | RAL 9010<br>Tbrill®                 |    |    |
| 13T010090   | 87-90                   | RAL 9010<br>Tbrill®                 |    |    |

Misure speciali L

Special sizes L

| Codice Code | su misura bespoke | Finiture profili Profiles finishing | 30 | 34 |
|-------------|-------------------|-------------------------------------|----|----|
| 13T019001   | 70 < L < 76       | RAL 9010<br>Tbrill®                 |    |    |
| 13T019001   | 77 < L < 86       | RAL 9010<br>Tbrill®                 |    |    |
| 13T019001   | 87 < L < 100      | RAL 9010<br>Tbrill®                 |    |    |
| 13T019001   | 101 < L < 120     | RAL 9010<br>Tbrill®                 |    |    |

attenzione

Il prezzo della L speciale va trovato nella tabella Misure speciali L in base alla L della parete doccia

Special price for L is to be found in Special sizes L as per L needed size

warning

Il prezzo delle misure speciali è inteso per lato

Special sizes: prices are to be intended for one side

Installazione su piatto doccia semicircolare raggio 55 cm

Installation on quadrant shower tray radius 55 cm

Misure speciali

| L | min | 70 cm  |
|---|-----|--------|
| L | max | 120 cm |

Disponibilità

| Disponibilità | Availability |
|---------------|--------------|
| STOCK         | STOCK        |
| STOCK         | STOCK        |

RAL9010

| RAL9010 | Tbrill® |
|---------|---------|
|         |         |

supplementi

Profilo di compensazione 3 cm  
Extension profile 3 cm

€

05 acrilico satin  
11 flack  
12 reflex  
16 satinato  
24 nigol  
25 flute  
26 wave  
27 aion  
28 fumè brown  
29 fumè  
30 trasparente  
31 extrachiaro  
32 cingilla  
34 stampato C

supplements

Set trattamento Neverdrop®  
set Neverdrop®

€

36A010004

Sigillante SPARTAN®  
Sealant SPARTAN®

€

36B010010

Approfondimenti



|  |     |
|--|-----|
| Indice Index                           | 3   |
| Legenda simboli Icons legend           | 11  |
| Profili - Vetri Profiles - Glasses     | 21  |
| Ricambi Spare parts                    | 406 |
| Profili speciali Special profiles      | 434 |
| Schede rilievo misure Measurement form | 444 |

origin

20 RAL9010

abitat

24 Tbrill®

Parete doccia semicircolare con doppia porta scorrevole  
Quadrant shower enclosure with double sliding door



incluso

included



disponibile

available

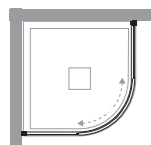

## installazioni

ad angolo corner  
DN-T38

## installations

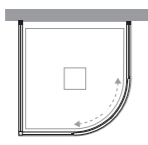
a tre lati three sides  
DN-T38+DN-F

## informazioni

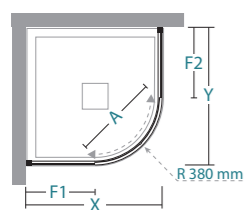

## informations

apertura scorrevole  
sliding door

| X/Y   | A  | F1/F2 |  |  |  |  |  |  |  |
|-------|----|-------|--|--|--|--|--|--|--|
| 72-75 | 45 | 31    |  |  |  |  |  |  |  |

X/Y lunghezza parete doccia\ shower wall length  
A spazio d'entrata\ entrance space  
F1 / F2 lunghezza lato fisso\ fixed side length

## DN-T38

INSTALLAZIONE AD ANGOLO O A TRE LATI  
CORNER OR THREE SIDES INSTALLATION

## Misure standard

Standard sizes

| Codice Code | estensibilità extension | Finiture profili Profiles finishing | 30 | 34 |
|-------------|-------------------------|-------------------------------------|----|----|
| 13T010075   | 72-75                   | RAL 9010<br>Tbrill®                 |    |    |

## Misure speciali L

Special sizes L

| Codice Code | su misura bespoke | Finiture profili Profiles finishing | 30 | 34 |
|-------------|-------------------|-------------------------------------|----|----|
| 13T019002   | 60 < L < 71       | RAL 9010<br>Tbrill®                 |    |    |
| 13T019002   | 72 < L < 90       | RAL 9010<br>Tbrill®                 |    |    |
| 13T019002   | 91 < L < 120      | RAL 9010<br>Tbrill®                 |    |    |

## attenzione

Il prezzo della L speciale va trovato nella tabella Misure speciali L in base alla L della parete doccia

Special price for L is to be found in Special sizes L as per L needed size

## warning

Il prezzo delle misure speciali è inteso per lato

Special sizes: prices are to be intended for one side

Installazione su piatto doccia semicircolare 75x75 raggio 38 cm

Installation on quadrant shower tray 75x75 radius 38 cm

DN-T38 di serie con le due porte di uguale dimensione

DN-T38 standard with two doors of equal size

Approfondimenti  
Insights

|  |     |
|--|-----|
| Indice Index                           | 3   |
| Legenda simboli Icons legend           | 11  |
| Profili - Vetri Profiles - Glasses     | 21  |
| Ricambi Spare parts                    | 406 |
| Profili speciali Special profiles      | 434 |
| Schede rilievo misure Measurement form | 444 |

Misure speciali  
Special size

L min 60 cm  
L max 120 cm

## supplementi

supplements



| Profilo di compensazione 3 cm<br>Extension profile 3 cm | Set trattamento Neverdrop®<br>set Neverdrop® | Sigillante SPARTAN®<br>Sealant SPARTAN® |
|---|--|---|
| 35A080200   | 36A010004                                    | 36B010010                               |

|                |            |        |          |       |       |      |      |            |      |             |             |          |            |
|----------------|------------|--------|----------|-------|-------|------|------|------------|------|-------------|-------------|----------|------------|
| 05             | 11         | 12     | 16       | 24    | 25    | 26   | 27   | 28         | 29   | 30          | 31          | 32       | 34         |
| acrilico satin | flack      | reflex | satinato | nigol | flute | wave | alou | fumè brown | fumè | trasparente | extrachiaro | cincillà | stampato C |
| origin         | abitat     |        |          |       |       |      |      |            |      |             |             |          |            |
| 20 RAL9010     | 24 Tbrill® |        |          |       |       |      |      |            |      |             |             |          |            |

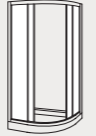









incluso



included

disponibile

available

installazioni installations



informazioni informations

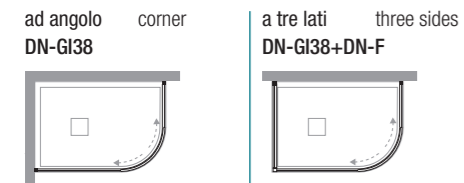

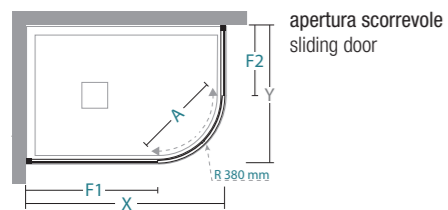
| X     | Y     | A  | F1 | F2 |  |  |  |  |  |
|-------|-------|----|----|----|--|--|--|--|--|
| 87-90 | 67-70 | 43 | 46 | 26 |  |  |  |  |  |

X / Y lunghezza parete doccia \ shower wall length  
A spazio d'entrata \ entrance space  
F1 / F2 lunghezza lato fisso \ fixed side length

| Misure standard |                         | Standard sizes                      |       |
|-----------------|-------------------------|-------------------------------------|-------|
| Codice Code     | estensibilità extension | Finiture profili Profiles finishing |       |
| 13T020001       | 67-70/87-90             | RAL 9010<br>Tbrill®                 | 30 34 |

| Misure speciali L |                   | Special sizes L                     |       |
|-------------------|-------------------|-------------------------------------|-------|
| Codice Code       | su misura bespoke | Finiture profili Profiles finishing |       |
| 13T029001         | 60 < L < 66       | RAL 9010<br>Tbrill®                 | 30 34 |
| 13T029001         | 67 < L < 86       | RAL 9010<br>Tbrill®                 |       |
| 13T029001         | 87 < L < 100      | RAL 9010<br>Tbrill®                 |       |
| 13T029001         | 101 < L < 120     | RAL 9010<br>Tbrill®                 |       |

attenzione warning

Il prezzo della L speciale va trovato nella tabella Misure speciali L in base alla L della parete doccia  
Special price for L is to be found in Special sizes L as per L needed size

Il prezzo delle misure speciali è inteso per lato  
Special sizes: prices are to be intended for one side

Installazione su piatto doccia semicircolare raggio 38 cm  
Installation on quadrant shower tray radius 38 cm

| Misure speciali Special size | Disponibilità Availability |         |
|------------------------------|----------------------------|---------|
| L min 60 cm<br>L max 120 cm  | STOCK                      | Tbrill® |

supplementi supplements

| Profilo di compensazione 3 cm Extension profile 3 cm | Set trattamento Neverdrop® set Neverdrop® | Sigillante SPARTAN® Sealant SPARTAN® |
|--|---|--------------------------------------|
| 35A080200 €  | 36A010004 €                               | 36B010010 €                          |

| 05             | 11    | 12     | 16       | 24    | 25    | 26         | 27   | 28         | 29   | 30          | 31          | 32       | 34         |
|----------------|-------|--------|----------|-------|-------|------------|------|------------|------|-------------|-------------|----------|------------|
| acrilico satin | flack | reflex | satinato | nigol | flute | wave       | alon | fumè brown | fumè | trasparente | extrachiaro | cincillà | stampato C |
| origin         |       |        |          |       |       | abitat     |      |            |      |             |             |          |            |
| 20 RAL9010     |       |        |          |       |       | 24 Tbrill® |      |            |      |             |             |          |            |

Approfondimenti Insights



|  |     |
|--|-----|
| Indice Index                           | 3   |
| Legenda simboli Icons legend           | 11  |
| Profili - Vetri Profiles - Glasses     | 21  |
| Ricambi Spare parts                    | 406 |
| Profili speciali Special profiles      | 434 |
| Schede rilievo misure Measurement form | 444 |



**Misure standard**

H cm 200  
4 mm  
REV

incluso included

3 cm  
L/H

disponibile available

3 cm  
NEVERDROP®  
3

## installazioni

ad angolo (\*)

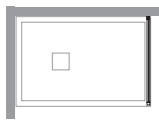

## installations

a tre lati (\*)

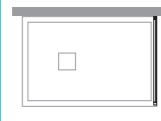

## informazioni

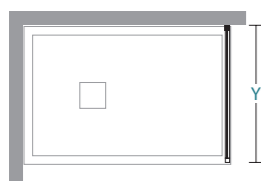

Y lunghezza parete doccia\ shower wall length

## informations

| Y       |  |  |  |  |  |   |    |  |  |
|---------|--|--|--|--|--|---|----|--|--|
| 67-70   |  |  |  |  |  | 1 | 18 |  |  |
| 72-75   |  |  |  |  |  | 1 | 19 |  |  |
| 77-80   |  |  |  |  |  | 1 | 20 |  |  |
| 82-85   |  |  |  |  |  | 1 | 21 |  |  |
| 87-90   |  |  |  |  |  | 1 | 22 |  |  |
| 97-100  |  |  |  |  |  | 1 | 25 |  |  |
| 117-120 |  |  |  |  |  | 1 | 29 |  |  |

## Misure standard

| Codice<br>Code | estensibilità<br>extension | Finiture profili<br>Profiles finishing | 30 | 34 |
|----------------|----------------------------|--|----|----|
| 13F010070      | 67-70                      | RAL 9010<br>Tbrill®                    |    |    |
| 13F010075      | 72-75                      | RAL 9010<br>Tbrill®                    |    |    |
| 13F010080      | 77-80                      | RAL 9010<br>Tbrill®                    |    |    |
| 13F010085      | 82-85                      | RAL 9010<br>Tbrill®                    |    |    |
| 13F010090      | 87-90                      | RAL 9010<br>Tbrill®                    |    |    |
| 13F010100      | 97-100                     | RAL 9010<br>Tbrill®                    |    |    |
| 13F010120      | 117-120                    | RAL 9010<br>Tbrill®                    |    |    |

## Standard sizes

## Misure speciali L / H

| Codice<br>Code | (**) | su misura<br>bespoke | Finiture profili<br>Profiles finishing | 30 | 34 |
|----------------|------|----------------------|--|----|----|
| 13F019001      |      | 12 < L < 60          | RAL 9010<br>Tbrill®                    |    |    |
| 13F019001      |      | 61 < L < 80          | RAL 9010<br>Tbrill®                    |    |    |
| 13F019001      |      | 81 < L < 100         | RAL 9010<br>Tbrill®                    |    |    |
| 13F019001      |      | 101 < L < 120        | RAL 9010<br>Tbrill®                    |    |    |

## Special sizes L / H

## attenzione

Il prezzo della H speciale va trovato nella tabella Misure speciali L / H in base alla L della parete doccia

Special price for H is to be found in Special sizes L / H as per L needed size

## warning

Obbligatorio il supporto 36S117002 per installazione 3 lati

36S117002 support required for 3-sided installation

(\*) DN-F è abbinabile a tutte le pareti doccia DN- PSC, PSC2, ASC, PSO, PGI, PSA2, T55, T38, GI38

(\*) DN-F to match all shower enclosures DN- PSC, PSC2, ASC, PSO, PGI, PSA2, T55, T38, GI38

Misure speciali  
Special size

|   |     |        |
|---|-----|--------|
| H | max | 200 cm |
| L | min | 12 cm  |
| L | max | 120 cm |

Disponibilità  
Availability

|   |       |         |
|---|-------|---------|
| ■ | STOCK | RAL9010 |
| ■ | STOCK | Tbrill® |

## supplementi

Profilo di compensazione 3 cm  
Extension profile 3 cm

€ 35A080200

Set trattamento Neverdrop®  
set Neverdrop®

€ 36A010004

## supplements

Sigillante SPARTAN®  
Sealant SPARTAN®

€ 36B010010

Approfondimenti  
Insights

|   |     |
|---|-----|
| Indice<br>Index                           | 3   |
| Legenda simboli<br>Icons legend           | 11  |
| Profili - Vetri<br>Profiles - Glasses     | 21  |
| Ricambi<br>Spare parts                    | 406 |
| Profili speciali<br>Special profiles      | 434 |
| Schede rilievo misure<br>Measurement form | 444 |

| 05             | 11    | 12     | 16       | 24    | 25    | 26         | 27   | 28         | 29   | 30          | 31          | 32       | 34         |
|----------------|-------|--------|----------|-------|-------|------------|------|------------|------|-------------|-------------|----------|------------|
| acrilico satin | flack | reflex | satinato | nigol | flute | wave       | alon | fumè brown | fumè | trasparente | extrachiara | cincillà | stampato C |
| origin         |       |        |          |       |       | abitat     |      |            |      |             |             |          |            |
| 20 RAL9010     |       |        |          |       |       | 24 Tbrill® |      |            |      |             |             |          |            |



Porta scorrevole installazione ad angolo  
profilo Tbrill® / vetro Stampato C  
Piatto doccia ARTURO

Sliding door corner installation  
Tbrill® profile / Stampato C glass  
Shower tray ARTURO

## CON TELAIO WITH FRAME

### SPADO

Il disegno lineare dei profili, la giunzione angolare a 45°, gli scorrimenti su doppio cuscinetto basculante e lo sgancio inferiore della porta la rendono perfetta nel contract. Una parete doccia elegante ma dai molteplici accorgimenti tecnici come i profili di rotazione sulle ante girevoli, le regolazioni accurate delle doppie ruote sulle ante scorrevoli e il sistema di sgancio dell'anta per facilitarne la pulizia. La serie è adatta ad ambienti bagno in cui la funzionalità non esclude la raffinatezza

Linear profiles, a 45° corner connection, twin wheels on double pivot bearings and the quick release system make this a perfect product for contract. An elegant shower wall with multiple technical features such as rotation profiles on hinged doors, precise adjustments of the twin wheels on the sliding doors and the door release system to improve the cleaning process, making it easier. This series is perfect for those bathrooms where functionality is just as imperative as elegance



01



02



03



04



05

**01** gruppo di scorrimento regolabile con doppio cuscinetto a sfera | **02** fermo centrale per modello apertura saloon | **03** sistema di sgancio rapido applicato direttamente all'anta | **04** profilo a due vie | **05** maniglia esterna, interasse 160mm |

**01** adjustable sliding block with twin wheels | **02** central stop for saloon doors | **03** quick door release system | **04** two-way profile | **05** external handle, interaxe 160mm |



### CARATTERISTICHE FEATURES

- H cm 190** ALTEZZA PARETI DOCCIA  
SHOWER DOOR HEIGHT
- 6 mm** SPESSORE LASTRA  
GLASS DEPTH
- REV** REVERSIBILE  
REVERSIBLE

### INFO TECNICHE TECHNICAL INFORMATION

- REGOLAZIONE FUORI SQUADRO**  
OFF-SQUARE REGULATION
- EST cm** ESTENSIBILITÀ 3/6  
EXSTENSIBILITY 3/6
- SGANCIO RAPIDO**  
QUICK-RELEASE
- PROFILO MAGNETICO**  
MAGNETIC PROFILE
- MANIGLIA ESTERNA/POMOLO INTERNO**  
EXTERNAL HANDLE/INTERNAL POMMEL
- MISURE SPECIALI**  
SPECIAL SIZES

### Finiture profili

#### ORIGIN



20  
RAL 9010

### Profiles finishing

#### ABITAT



24  
Tbrill®

### Vetri



30  
Trasparente



34  
Stampato C

### Glasses

### installazioni previste allowed installations

#### in nicchia

SD-PSC

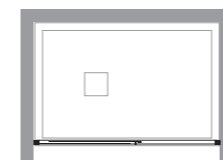

SD-PSC2

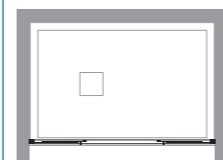

#### niche

SD-PSO

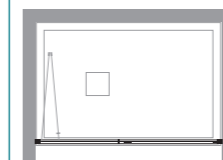

SD-PGI

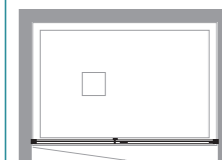

SD-PSA2

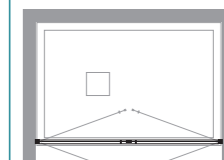

#### ad angolo

SD-PSC + SD-F

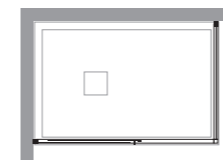

SD-PSC2 + SD-F

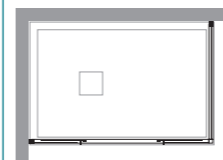

#### corner

SD-ASC + SD-ASC

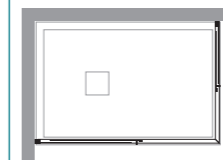

SD-PSO + SD-F

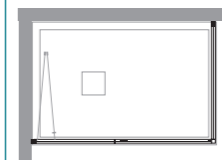

SD-PGI + SD-F

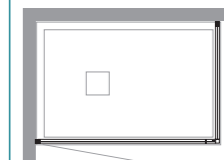

SD-PSA2 + SD-F

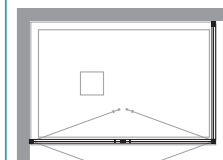

#### a tre lati

SD-PSC + 2 x SD-F



SD-PSC2 + 2 x SD-F

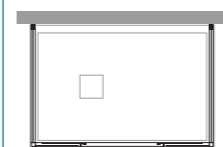

#### three sides

2 X SD-ASC + SD-F



SD-PSO + 2 x SD-F



SD-PGI + 2 x SD-F



SD-PSA2 + 2 x SD-F

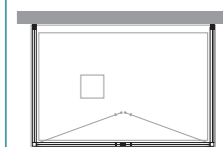

### profili

### profiles

per/for **SD: ASC-T55-T38-GI38**

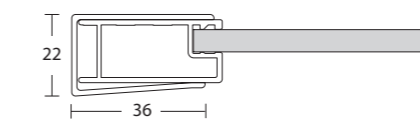

profilo a muro 1327 + schienale 1123

wall profile 1327 + vertical profile 1123

per/for **SD: PSC-PSC2-PSO-PGI-PSA2**

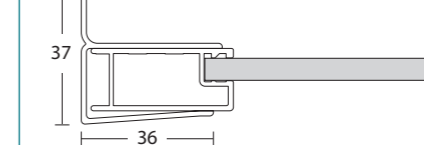

profilo a muro 1119 + schienale 1123

wall profile 1119 + vertical profile 1123

### importante

### important

ordini per pareti doccia speciali senza relativo disegno  
**NON** vengono prodotti

orders for special shower walls without related design are  
**NOT** produced



H cm 190
6 mm
REV

incluso      included

disponibile      available

3 cm
NEVERDROP®

installazioni

in nicchia    niche  
**SD-PSC**

ad angolo    corner  
**SD-PSC+SD-F**

a tre lati    three sides  
**SD-PSC+2xSD-F**

informazioni

apertura scorrevole  
sliding door

**X** lunghezza parete doccia \ shower wall length  
**A** spazio d'entrata \ entrance space  
**F** lunghezza lato fisso \ fixed side length

informations

|         | X  | A   | F |  |  |  |  |  |  |   |    |
|---------|----|-----|---|--|--|--|--|--|--|---|----|
| 96-102  | 39 | 46  |   |  |  |  |  |  |  | 1 | 39 |
| 106-112 | 44 | 51  |   |  |  |  |  |  |  | 1 | 41 |
| 116-122 | 49 | 56  |   |  |  |  |  |  |  | 1 | 44 |
| 126-132 | 54 | 61  |   |  |  |  |  |  |  | 2 | 52 |
| 136-142 | 59 | 66  |   |  |  |  |  |  |  | 2 | 55 |
| 146-152 | 64 | 71  |   |  |  |  |  |  |  | 2 | 59 |
| 156-162 | 64 | 81  |   |  |  |  |  |  |  | 2 | 60 |
| 166-172 | 64 | 91  |   |  |  |  |  |  |  | 2 | 65 |
| 176-182 | 64 | 101 |   |  |  |  |  |  |  | 2 | 66 |

## SD-PSC

INSTALLAZIONE IN NICCHIA, AD ANGOLO O A TRE LATI  
NICHE, CORNER OR THREE SIDES INSTALLATION

Misure standard

| Codice<br>Code | estensibilità<br>extension | Finiture profili<br>Profiles finishing | 30                                  | 34                       |
|----------------|----------------------------|--|-------------------------------------|--------------------------|
| 06P100100      | 96-102                     | RAL 9010<br>Tbrill®                    | <input checked="" type="checkbox"/> | <input type="checkbox"/> |
| 06P100110      | 106-112                    | RAL 9010<br>Tbrill®                    | <input checked="" type="checkbox"/> | <input type="checkbox"/> |
| 06P100120      | 116-122                    | RAL 9010<br>Tbrill®                    | <input checked="" type="checkbox"/> | <input type="checkbox"/> |
| 06P100130      | 126-132                    | RAL 9010<br>Tbrill®                    | <input checked="" type="checkbox"/> | <input type="checkbox"/> |
| 06P100140      | 136-142                    | RAL 9010<br>Tbrill®                    | <input checked="" type="checkbox"/> | <input type="checkbox"/> |
| 06P100150      | 146-152                    | RAL 9010<br>Tbrill®                    | <input checked="" type="checkbox"/> | <input type="checkbox"/> |
| 06P100160      | 156-162                    | RAL 9010<br>Tbrill®                    | <input checked="" type="checkbox"/> | <input type="checkbox"/> |
| 06P100170      | 166-172                    | RAL 9010<br>Tbrill®                    | <input checked="" type="checkbox"/> | <input type="checkbox"/> |
| 06P100180      | 176-182                    | RAL 9010<br>Tbrill®                    | <input checked="" type="checkbox"/> | <input type="checkbox"/> |

Standard sizes

Misure speciali L / H

| Codice<br>Code | su misura<br>bespoke | Finiture profili<br>Profiles finishing | 30                       | 34                       |
|----------------|----------------------|--|--------------------------|--------------------------|
| 06P109001      | 90 < L < 120         | RAL 9010<br>Tbrill®                    | <input type="checkbox"/> | <input type="checkbox"/> |
| 06P109001      | 121 < L < 150        | RAL 9010<br>Tbrill®                    | <input type="checkbox"/> | <input type="checkbox"/> |
| 06P109001      | 151 < L < 180        | RAL 9010<br>Tbrill®                    | <input type="checkbox"/> | <input type="checkbox"/> |

Special sizes L / H

attenzione

Il prezzo della H speciale va trovato nella tabella Misure speciali L / H in base alla L della parete doccia

Special price for H is to be found in Special sizes L / H as per L needed size

warning

Misure speciali  
Special size

|   |     |     |                                     |       |         |
|---|-----|-----|-------------------------------------|-------|---------|
| H | max | 190 | <input checked="" type="checkbox"/> | STOCK | Tbrill® |
| L | min | 90  |                                     |       |         |
| L | max | 180 |                                     |       |         |

Disponibilità  
Availability

STOCK Tbrill®

supplementi

Profilo di compensazione 3 cm  
Extension profile 3 cm

€ 35A010190

supplements

Set trattamento Neverdrop®  
set Neverdrop®

€ 36A010004

supplements

Sigillante SPARTAN®  
Sealant SPARTAN®

€ 36B010010

|                                      |                     |                       |                    |                    |                   |                             |                         |                   |                          |                          |                       |                         |                         |
|--------------------------------------|---------------------|-----------------------|--------------------|--------------------|-------------------|-----------------------------|-------------------------|-------------------|--------------------------|--------------------------|-----------------------|-------------------------|-------------------------|
| <b>05</b><br>acrilico satin<br>flack | <b>11</b><br>reflex | <b>12</b><br>satinato | <b>16</b><br>nigol | <b>24</b><br>flute | <b>25</b><br>wave | <b>26</b><br>aion           | <b>27</b><br>fumè brown | <b>28</b><br>fumè | <b>29</b><br>trasparente | <b>30</b><br>extrachiara | <b>31</b><br>cincillà | <b>32</b><br>stampato C | <b>34</b><br>stampato C |
| <b>origin</b><br>20 RAL9010          |                     |                       |                    |                    |                   | <b>abitat</b><br>24 Tbrill® |                         |                   |                          |                          |                       |                         |                         |

Approfondimenti  
Insights



|   |     |
|---|-----|
| Indice<br>Index                           | 3   |
| Legenda simboli<br>Icons legend           | 11  |
| Profili - Vetri<br>Profiles - Glasses     | 21  |
| Ricambi<br>Spare parts                    | 406 |
| Profili speciali<br>Special profiles      | 434 |
| Schede rilievo misure<br>Measurement form | 444 |



incluso

included



disponibile

available

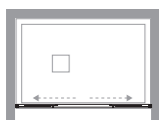

## installazioni

in nicchia niche  
SD-PSC2

## installations

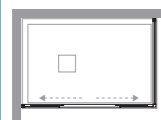
ad angolo corner  
SD-PSC2+SD-Fa tre lati three sides  
SD-PSC2+2xSD-F

## informazioni

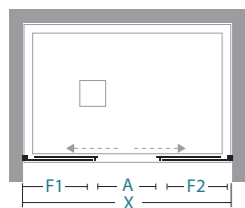
apertura scorrevole  
sliding door

## informations

| X       | A  | F1/F2 |  |  |  |  |  |   |    |
|---------|----|-------|--|--|--|--|--|---|----|
| 106-112 | 41 | 27    |  |  |  |  |  | 2 | 43 |
| 116-122 | 45 | 30    |  |  |  |  |  | 2 | 45 |
| 126-132 | 45 | 35    |  |  |  |  |  | 2 | 50 |
| 136-142 | 55 | 35    |  |  |  |  |  | 2 | 52 |
| 146-152 | 55 | 40    |  |  |  |  |  | 2 | 54 |
| 156-162 | 65 | 40    |  |  |  |  |  | 2 | 60 |
| 166-172 | 65 | 45    |  |  |  |  |  | 2 | 63 |
| 176-182 | 75 | 45    |  |  |  |  |  | 2 | 66 |

X lunghezza parete doccia\ shower wall length  
A spazio d'entrata\ entrance space  
F1 / F2 lunghezza lato fisso\ fixed side length

## Misure standard

## Standard sizes

| Codice<br>Code | estensibilità<br>extension | Finiture profili<br>Profiles finishing | 30 | 34 |
|----------------|----------------------------|--|----|----|
| 06P120110      | 106-112                    | RAL 9010<br>Tbrill®                    |    |    |
| 06P120120      | 116-122                    | RAL 9010<br>Tbrill®                    |    |    |
| 06P120130      | 126-132                    | RAL 9010<br>Tbrill®                    |    |    |
| 06P120140      | 136-142                    | RAL 9010<br>Tbrill®                    |    |    |
| 06P120150      | 146-152                    | RAL 9010<br>Tbrill®                    |    |    |
| 06P120160      | 156-162                    | RAL 9010<br>Tbrill®                    |    |    |
| 06P120170      | 166-172                    | RAL 9010<br>Tbrill®                    |    |    |
| 06P120180      | 176-182                    | RAL 9010<br>Tbrill®                    |    |    |

## Misure speciali L / H

## Special sizes L / H

| Codice<br>Code | su misura<br>bespoke | Finiture profili<br>Profiles finishing | 30 | 34 |
|----------------|----------------------|--|----|----|
| 06P129001      | 90 < L < 120         | RAL 9010<br>Tbrill®                    |    |    |
| 06P129001      | 121 < L < 150        | RAL 9010<br>Tbrill®                    |    |    |
| 06P129001      | 151 < L < 180        | RAL 9010<br>Tbrill®                    |    |    |

## attenzione

Il prezzo della H speciale va trovato nella tabella Misure speciali L / H in base alla L della parete doccia

Special price for H is to be found in Special sizes L / H as per L needed size

## warning

Misure speciali  
Special size

|   |     |     |
|---|-----|-----|
| H | max | 190 |
| L | min | 90  |
| L | max | 180 |

## supplementi

## supplements

| Profilo di compensazione 3 cm<br>Extension profile 3 cm | Set trattamento Neverdrop®<br>set Neverdrop® | Sigillante SPARTAN®<br>Sealant SPARTAN® |
|---|--|---|
| 35A010190   | 36A010004                                    | 36B010010                               |
| €   | €  | €                                       |

| 05                      | 11         | 12       | 16    | 24    | 25   | 26   | 27         | 28   | 29          | 30          | 31       | 32         | 34 |
|-------------------------|------------|----------|-------|-------|------|------|------------|------|-------------|-------------|----------|------------|----|
| acrilico satin<br>flack | reflex     | satinato | nigol | flute | wave | alon | fumè brown | fumè | trasparente | extrachiaro | cincillà | stampato C |    |
| origin                  | abitat     |          |       |       |      |      |            |      |             |             |          |            |    |
| 20 RAL9010              | 24 Tbrill® |          |       |       |      |      |            |      |             |             |          |            |    |

Approfondimenti  
Insights

|   |     |
|---|-----|
| Indice<br>Index                           | 3   |
| Legenda simboli<br>Icons legend           | 11  |
| Profili - Vetri<br>Profiles - Glasses     | 21  |
| Ricambi<br>Spare parts                    | 406 |
| Profili speciali<br>Special profiles      | 434 |
| Schede rilievo misure<br>Measurement form | 444 |







H cm  
190





6 mm





REV

incluso      included

















disponibile      available







installazioni      installations

ad angolo      corner  
SD-ASC+SD-ASC





a tre lati      three sides  
2xSD-ASC+SD-F

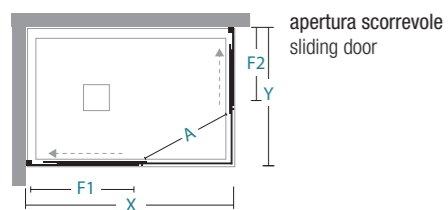

informazioni      informations



**XY** lunghezza parete doccia\ shower wall length  
**A** spazio d'entrata\ entrance space  
**F1/F2** lunghezza lato fisso\ fixed side length

| X/Y     | 67-70 | 72-75 | 77-80 | 87-90 | 97-100 | 117-120 | F1/F2 |  |  |
|---------|-------|-------|-------|-------|--------|---------|-------|---|---|
| 67-70   | A=36  |       |       |       |        |         | 32    | 1   | 24  |
| 72-75   | A=38  | A=39  |       |       |        |         | 35    | 1   | 25  |
| 77-80   | A=40  | A=41  | A=43  |       |        |         | 38    | 1   | 26  |
| 87-90   | A=44  | A=45  | A=47  | A=50  |        |         | 43    | 1   | 31  |
| 97-100  | A=44  | A=45  | A=47  | A=50  | A=50   |         | 52    | 1   | 34  |
| 117-120 | A=44  | A=45  | A=47  | A=50  | A=50   | A=50    | 72    | 1   | 39  |

Misure standard      Standard sizes

| Codice<br>Code | estensibilità<br>extension | Finiture profili<br>Profiles finishing | 30                                  | 34                                  |
|----------------|----------------------------|--|-------------------------------------|-------------------------------------|
| 06A100070      | 67-70                      | RAL 9010<br>Tbrill®                    | <input checked="" type="checkbox"/> | <input checked="" type="checkbox"/> |
| 06A100075      | 72-75                      | RAL 9010<br>Tbrill®                    | <input checked="" type="checkbox"/> | <input type="checkbox"/>            |
| 06A100080      | 77-80                      | RAL 9010<br>Tbrill®                    | <input checked="" type="checkbox"/> | <input checked="" type="checkbox"/> |
| 06A100090      | 87-90                      | RAL 9010<br>Tbrill®                    | <input checked="" type="checkbox"/> | <input checked="" type="checkbox"/> |
| 06A100100      | 97-100                     | RAL 9010<br>Tbrill®                    | <input checked="" type="checkbox"/> | <input checked="" type="checkbox"/> |
| 06A100120      | 117-120                    | RAL 9010<br>Tbrill®                    | <input checked="" type="checkbox"/> | <input type="checkbox"/>            |

Misure speciali L / H      Special sizes L / H

| Codice<br>Code | su misura<br>bespoke | Finiture profili<br>Profiles finishing | 30                       | 34                       |
|----------------|----------------------|--|--------------------------|--------------------------|
| 06A109001      | 45 < L < 60          | RAL 9010<br>Tbrill®                    | <input type="checkbox"/> | <input type="checkbox"/> |
| 06A109001      | 61 < L < 90          | RAL 9010<br>Tbrill®                    | <input type="checkbox"/> | <input type="checkbox"/> |
| 06A109001      | 91 < L < 120         | RAL 9010<br>Tbrill®                    | <input type="checkbox"/> | <input type="checkbox"/> |

attenzione      warning

Il prezzo della H speciale va trovato nella tabella Misure speciali L / H in base alla L della parete doccia

Special price for H is to be found in Special sizes L / H as per L needed size

Il prezzo è inteso per lato

Prices are to be intended for one side

| Misure speciali<br>Special size | Disponibilità<br>Availability             |         |
|---------------------------------|---|---------|
| H max 190                       | <input checked="" type="checkbox"/> STOCK | Tbrill® |
| L min 45                        |   |         |
| L max 120                       |   |         |

supplementi      supplements

| Profilo di compensazione 3 cm<br>Extension profile 3 cm | Set trattamento Neverdrop®<br>set Neverdrop® | Sigillante SPARTAN®<br>Sealant SPARTAN® |
|---|--|---|
| 35A010190   | 36A010004                                    | 36B010010                               |

| 05             | 11    | 12     | 16       | 24    | 25    | 26         | 27   | 28         | 29   | 30          | 31           | 32       | 34         |
|----------------|-------|--------|----------|-------|-------|------------|------|------------|------|-------------|--------------|----------|------------|
| acrilico satin | flack | reflex | satinato | nigol | flute | wave       | alon | fumè brown | fumè | trasparente | extrachiario | cincillà | stampato C |
| origin         |       |        |          |       |       | abitat     |      |            |      |             |              |          |            |
| 20 RAL9010     |       |        |          |       |       | 24 Tbrill® |      |            |      |             |              |          |            |

Approfondimenti  
Insights





|   |     |
|---|-----|
| Indice<br>Index                           | 3   |
| Legenda simboli<br>Icons legend           | 11  |
| Profili - Vetri<br>Profiles - Glasses     | 21  |
| Ricambi<br>Spare parts                    | 406 |
| Profili speciali<br>Special profiles      | 434 |
| Schede rilievo misure<br>Measurement form | 444 |

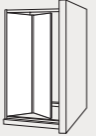







incluso

included



disponibile

installazioni

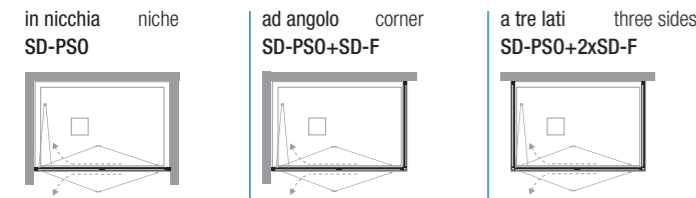

informazioni

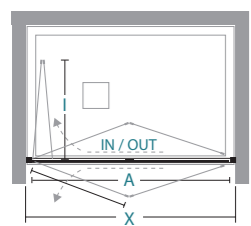

**X** lunghezza parete doccia\ shower wall length  
**A** spazio d'entrata\ entrance space  
**I** ingombro interno\ internal dimensions

installations

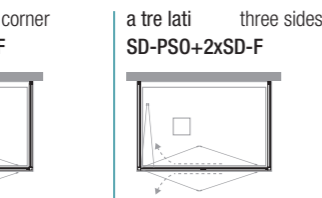

informations

|        | X  | A  | I |  |  |  |  |  |   |    |
|--------|----|----|---|--|--|--|--|--|---|----|
| 66-72  | 48 | 34 |   |  |  |  |  |  | 1 | 33 |
| 71-77  | 53 | 38 |   |  |  |  |  |  | 1 | 35 |
| 76-82  | 58 | 40 |   |  |  |  |  |  | 1 | 36 |
| 81-87  | 63 | 42 |   |  |  |  |  |  | 1 | 38 |
| 86-92  | 68 | 44 |   |  |  |  |  |  | 1 | 39 |
| 96-102 | 78 | 50 |   |  |  |  |  |  | 1 | 42 |

| Misure standard |                         | Standard sizes                      |    |    |
|-----------------|-------------------------|-------------------------------------|----|----|
| Codice Code     | estensibilità extension | Finiture profili Profiles finishing | 30 | 34 |
| 06P140070       | 66-72                   | RAL 9010<br>Tbrill®                 |    |    |
| 06P140075       | 71-77                   | RAL 9010<br>Tbrill®                 |    |    |
| 06P140080       | 76-82                   | RAL 9010<br>Tbrill®                 |    |    |
| 06P140085       | 81-87                   | RAL 9010<br>Tbrill®                 |    |    |
| 06P140090       | 86-92                   | RAL 9010<br>Tbrill®                 |    |    |
| 06P140100       | 96-102                  | RAL 9010<br>Tbrill®                 |    |    |

| Misure speciali L / H |                   | Special sizes L / H                 |    |    |
|-----------------------|-------------------|-------------------------------------|----|----|
| Codice Code           | su misura bespoke | Finiture profili Profiles finishing | 30 | 34 |
| 06P149001             | 60 < L < 80       | RAL 9010<br>Tbrill®                 |    |    |
| 06P149001             | 81 < L < 90       | RAL 9010<br>Tbrill®                 |    |    |
| 06P149001             | 91 < L < 100      | RAL 9010<br>Tbrill®                 |    |    |

attenzione

Il prezzo della H speciale va trovato nella tabella Misure speciali L / H in base alla L della parete doccia

Special price for H is to be found in Special sizes L / H as per L needed size

warning

| Misure speciali Special size | Disponibilità Availability |         |  |  |
|------------------------------|----------------------------|---------|--|--|
| H max 190                    | STOCK                      | Tbrill® |  |  |
| L min 60                     |                            |         |  |  |
| L max 100                    |                            |         |  |  |

| supplementi  |   | supplements                          |  |
|--|---|--------------------------------------|--|
| Profilo di compensazione 3 cm Extension profile 3 cm | Set trattamento Neverdrop® set Neverdrop® | Sigillante SPARTAN® Sealant SPARTAN® |  |
| 35A010190 €  | 36A010004 €                               | 36B010010 €                          |  |

Approfondimenti Insights



|  |     |
|--|-----|
| Indice Index                           | 3   |
| Legenda simboli Icons legend           | 11  |
| Profili - Vetri Profiles - Glasses     | 21  |
| Ricambi Spare parts                    | 406 |
| Profili speciali Special profiles      | 434 |
| Schede rilievo misure Measurement form | 444 |

| 05             | 11    | 12     | 16       | 24    | 25    | 26         | 27   | 28         | 29   | 30          | 31          | 32       | 34         |
|----------------|-------|--------|----------|-------|-------|------------|------|------------|------|-------------|-------------|----------|------------|
| acrilico satin | flack | reflex | satinato | nigol | flute | wave       | alon | fumè brown | fumè | trasparente | extrachiaro | cincillà | stampato C |
| origin         |       |        |          |       |       | abitat     |      |            |      |             |             |          |            |
| 20 RAL9010     |       |        |          |       |       | 24 Tbrill® |      |            |      |             |             |          |            |

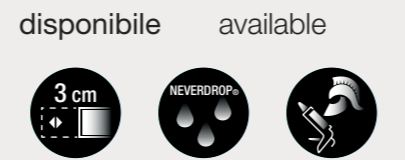
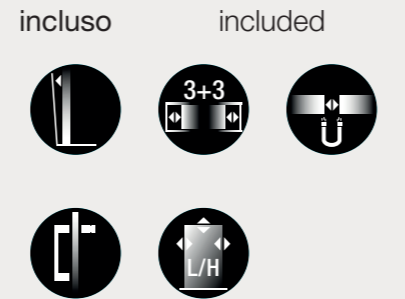
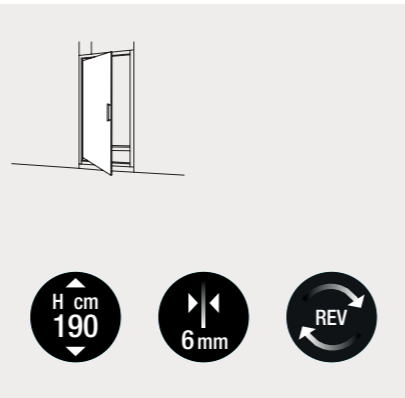

## installazioni

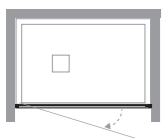
in nicchia niche  
SD-PGI

## installations

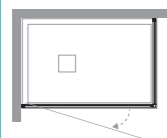
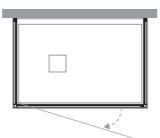
ad angolo corner  
SD-PGI+SP-Fa tre lati three sides  
SD-PGI+2xSD-F

## informazioni

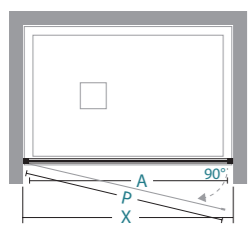

X lunghezza parete doccia\ shower wall length  
A spazio d'entrata\ entrance space  
P lunghezza porta\ door length

## informations

apertura girevole  
turning door

|       | X  | A  | P |  |  |  |  |  |   |    |
|-------|----|----|---|--|--|--|--|--|---|----|
| 66-72 | 54 | 51 |   |  |  |  |  |  | 1 | 30 |
| 71-77 | 59 | 56 |   |  |  |  |  |  | 1 | 32 |
| 76-82 | 64 | 61 |   |  |  |  |  |  | 1 | 33 |
| 81-87 | 69 | 66 |   |  |  |  |  |  | 1 | 35 |
| 86-92 | 74 | 71 |   |  |  |  |  |  | 1 | 37 |

## Misure standard

| Codice<br>Code | estensibilità<br>extension | Finiture profili<br>Profiles finishing | 30 | 34 |
|----------------|----------------------------|--|----|----|
| 06P160070      | 66-72                      | RAL 9010<br>Tbrill®                    |    |    |
| 06P160075      | 71-77                      | RAL 9010<br>Tbrill®                    |    |    |
| 06P160080      | 76-82                      | RAL 9010<br>Tbrill®                    |    |    |
| 06P160085      | 81-87                      | RAL 9010<br>Tbrill®                    |    |    |
| 06P160090      | 86-92                      | RAL 9010<br>Tbrill®                    |    |    |

## Standard sizes

## Misure speciali L / H

| Codice<br>Code | su misura<br>bespoke | Finiture profili<br>Profiles finishing | 30 | 34 |
|----------------|----------------------|--|----|----|
| 06P169001      | 50 < L < 60          | RAL 9010<br>Tbrill®                    |    |    |
| 06P169001      | 61 < L < 80          | RAL 9010<br>Tbrill®                    |    |    |
| 06P169001      | 81 < L < 90          | RAL 9010<br>Tbrill®                    |    |    |

## Special sizes L / H

## attenzione

Il prezzo della H speciale va trovato nella tabella Misure speciali L / H in base alla L della parete doccia

Special price for H is to be found in Special sizes L / H as per L needed size

## warning

Misure speciali  
Special size

|       |     |       |         |
|-------|-----|-------|---------|
| H max | 190 | STOCK | Tbrill® |
| L min | 50  |       |         |
| L max | 90  |       |         |

Disponibilità  
Availability

## supplementi

Profilo di compensazione 3 cm  
Extension profile 3 cm

€

35A010190

## supplements

Set trattamento Neverdrop®  
set Neverdrop®

€

36A010004

Sigillante SPARTAN®  
Sealant SPARTAN®

€

36B010010

|                |            |        |          |       |       |      |      |            |      |             |             |          |            |
|----------------|------------|--------|----------|-------|-------|------|------|------------|------|-------------|-------------|----------|------------|
| 05             | 11         | 12     | 16       | 24    | 25    | 26   | 27   | 28         | 29   | 30          | 31          | 32       | 34         |
| acrilico satin | flack      | reflex | satinato | nigol | flute | wave | alon | fumè brown | fumè | trasparente | extrachiaro | cincillà | stampato C |
| origin         | abitat     |        |          |       |       |      |      |            |      |             |             |          |            |
| 20 RAL9010     | 24 Tbrill® |        |          |       |       |      |      |            |      |             |             |          |            |

Approfondimenti  
Insights

|   |     |
|---|-----|
| Indice<br>Index                           | 3   |
| Legenda simboli<br>Icons legend           | 11  |
| Profili - Vetri<br>Profiles - Glasses     | 21  |
| Ricambi<br>Spare parts                    | 406 |
| Profili speciali<br>Special profiles      | 434 |
| Schede rilievo misure<br>Measurement form | 444 |



incluso      included

disponibile      available

installazioni

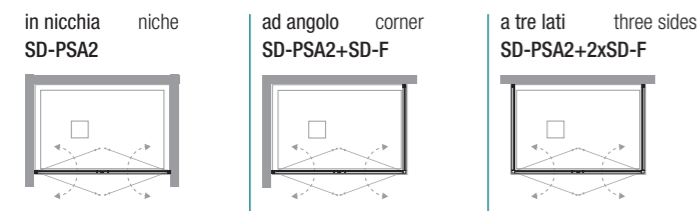

informazioni

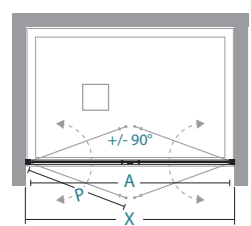

informations

apertura saloon  
saloon door

|         | X   | A    | P |  |  |  |  |  |   |    |
|---------|-----|------|---|--|--|--|--|--|---|----|
| 66-72   | 51  | 23,5 |   |  |  |  |  |  | 1 | 29 |
| 71-77   | 56  | 26   |   |  |  |  |  |  | 1 | 31 |
| 76-82   | 61  | 28,5 |   |  |  |  |  |  | 1 | 33 |
| 81-87   | 66  | 31   |   |  |  |  |  |  | 1 | 35 |
| 86-92   | 71  | 33,5 |   |  |  |  |  |  | 1 | 36 |
| 96-102  | 81  | 38,5 |   |  |  |  |  |  | 1 | 39 |
| 116-122 | 101 | 48,5 |   |  |  |  |  |  | 1 | 45 |

X lunghezza parete doccia\ shower wall length  
A spazio d'entrata\ entrance space  
P lunghezza porta\ door length

Misure standard

| Codice<br>Code | estensibilità<br>extension | Finiture profili<br>Profiles finishing | 30 | 34 |
|----------------|----------------------------|--|----|----|
| 06P180070      | 66-72                      | RAL 9010<br>Tbrill®                    |    |    |
| 06P180075      | 71-77                      | RAL 9010<br>Tbrill®                    |    |    |
| 06P180080      | 76-82                      | RAL 9010<br>Tbrill®                    |    |    |
| 06P180085      | 81-87                      | RAL 9010<br>Tbrill®                    |    |    |
| 06P180090      | 86-92                      | RAL 9010<br>Tbrill®                    |    |    |
| 06P180100      | 96-102                     | RAL 9010<br>Tbrill®                    |    |    |
| 06P180120      | 116-122                    | RAL 9010<br>Tbrill®                    |    |    |

Standard sizes

Misure speciali L / H

| Codice<br>Code | su misura<br>bespoke | Finiture profili<br>Profiles finishing | 30 | 34 |
|----------------|----------------------|--|----|----|
| 06P189001      | 50 < L < 70          | RAL 9010<br>Tbrill®                    |    |    |
| 06P189001      | 71 < L < 90          | RAL 9010<br>Tbrill®                    |    |    |
| 06P189001      | 91 < L < 120         | RAL 9010<br>Tbrill®                    |    |    |

Special sizes L / H

attenzione

Il prezzo della H speciale va trovato nella tabella Misure speciali L / H in base alla L della parete doccia

Special price for H is to be found in Special sizes L / H as per L needed size

warning

Misure speciali  
Special size

|       |     |  |       |         |
|-------|-----|--|-------|---------|
| H max | 190 |  | STOCK | Tbrill® |
| L min | 50  |  |       |         |
| L max | 120 |  |       |         |

Disponibilità  
Availability

STOCK Tbrill®

supplementi

Profilo di compensazione 3 cm  
Extension profile 3 cm

€ 35A010190

supplements

Set trattamento Neverdrop®  
set Neverdrop®

€ 36A010004

Sigillante SPARTAN®  
Sealant SPARTAN®

€ 36B010010

| 05             | 11    | 12     | 16       | 24    | 25    | 26         | 27   | 28         | 29   | 30          | 31          | 32       | 34         |
|----------------|-------|--------|----------|-------|-------|------------|------|------------|------|-------------|-------------|----------|------------|
| acrilico satin | flack | reflex | satinato | nigol | flute | wave       | alon | fumè brown | fumè | trasparente | extrachiaro | cincillà | stampato C |
| origin         |       |        |          |       |       | abitat     |      |            |      |             |             |          |            |
| 20 RAL9010     |       |        |          |       |       | 24 Tbrill® |      |            |      |             |             |          |            |

Approfondimenti  
Insights



|   |     |
|---|-----|
| Indice<br>Index                           | 3   |
| Legenda simboli<br>Icons legend           | 11  |
| Profili - Vetri<br>Profiles - Glasses     | 21  |
| Ricambi<br>Spare parts                    | 406 |
| Profili speciali<br>Special profiles      | 434 |
| Schede rilievo misure<br>Measurement form | 444 |







H cm  
190



6 mm



REV

incluso      included



3+3



L/H

disponibile      available



3 cm



NEVERDROP®



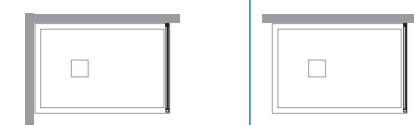

installazioni      installations  
ad angolo    corner  
(\*)      a tre lati    three sides  
(\*)

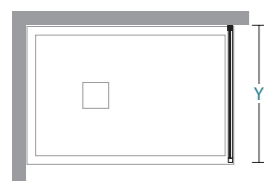

informazioni      informations



| Y      |  |  |  |  |  |  |  |  |  |  |  |
|--------|--|--|--|--|--|--|--|--|--|---|---|
| 66-72  |  |  |  |  |  |  |  |  |  | 1   | 25  |
| 71-77  |  |  |  |  |  |  |  |  |  | 1   | 26  |
| 76-82  |  |  |  |  |  |  |  |  |  | 1   | 28  |
| 86-92  |  |  |  |  |  |  |  |  |  | 1   | 32  |
| 96-102 |  |  |  |  |  |  |  |  |  | 1   | 36  |

Y      lunghezza parete doccia\ shower wall length

Misure standard      Standard sizes

| Codice<br>Code | estensibilità<br>extension | Finiture profili<br>Profiles finishing | 30 | 34 |
|----------------|----------------------------|--|----|----|
| 06F100070      | 66-72                      | RAL 9010<br>Tbrill®                    |    |    |
| 06F100075      | 71-77                      | RAL 9010<br>Tbrill®                    |    |    |
| 06F100080      | 76-82                      | RAL 9010<br>Tbrill®                    |    |    |
| 06F100090      | 86-92                      | RAL 9010<br>Tbrill®                    |    |    |
| 06F100100      | 96-102                     | RAL 9010<br>Tbrill®                    |    |    |

Misure speciali L / H      Special sizes L / H

| Codice<br>Code | su misura<br>bespoke | Finiture profili<br>Profiles finishing | 30 | 34 |
|----------------|----------------------|--|----|----|
| 06F109001      | 15 < L < 60          | RAL 9010<br>Tbrill®                    |    |    |
| 06F109001      | 61 < L < 80          | RAL 9010<br>Tbrill®                    |    |    |
| 06F109001      | 81 < L < 100         | RAL 9010<br>Tbrill®                    |    |    |
| 06F109001      | 101 < L < 120        | RAL 9010<br>Tbrill®                    |    |    |

Speciali - solo profili      Special - only profiles

| Codice<br>Code | su misura<br>bespoke | Finiture profili<br>Profiles finishing |  |  |
|----------------|----------------------|--|--|--|
| 06F109003      | L < 14               | RAL 9010<br>Tbrill®                    |  |  |

attenzione      warning

Il prezzo della H speciale va trovato nella tabella Misure speciali L / H in base alla L della parete doccia

Special price for H is to be found in Special sizes L / H as per L needed size

(\*) SD-F è abbinabile a tutte le pareti doccia SD- PSC, PSC2, ASC, PSO, PGI, PSA2

(\*) SD-F to match all shower enclosures SD- PSC, PSC2, ASC, PSO, PGI, PSA2

| Misure speciali<br>Special size | Disponibilità<br>Availability              |         |  |  |
|---------------------------------|--|---------|--|--|
| H max 190                       | <span style="color: blue;">■</span> STOCK  | RAL9010 |  |  |
| L min 15                        | <span style="color: green;">■</span> STOCK | Tbrill® |  |  |
| L max 120                       |  |         |  |  |

supplementi      supplements

| Profilo di compensazione 3 cm<br>Extension profile 3 cm | Set trattamento Neverdrop®<br>set Neverdrop® | Sigillante SPARTAN®<br>Sealant SPARTAN® |   |   |
|---|--|---|---|---|
| 35A010190   | 36A010004                                    | 36B010010                               | € | € |

| 05             | 11    | 12     | 16       | 24    | 25    | 26         | 27   | 28         | 29   | 30          | 31           | 32       | 34         |
|----------------|-------|--------|----------|-------|-------|------------|------|------------|------|-------------|--------------|----------|------------|
| acrilico satin | flack | reflex | satinato | nigol | flute | wave       | alon | fumè brown | fumè | trasparente | extrachiario | cincillà | stampato C |
| origin         |       |        |          |       |       | abitat     |      |            |      |             |              |          |            |
| 20 RAL9010     |       |        |          |       |       | 24 Tbrill® |      |            |      |             |              |          |            |

Approfondimenti  
Insights



|   |     |
|---|-----|
| Indice<br>Index                           | 3   |
| Legenda simboli<br>Icons legend           | 11  |
| Profili - Vetri<br>Profiles - Glasses     | 21  |
| Ricambi<br>Spare parts                    | 406 |
| Profili speciali<br>Special profiles      | 434 |
| Schede rilievo misure<br>Measurement form | 444 |



Porta scorrevole installazione ad angolo  
profilo Tcrom® / vetro Trasparente  
piatto doccia ARTURO

Sliding doors corner installation  
Tcrom® profile / Transparent glass  
Shower tray ARTURO

## COMFORT

La vasta gamma di modelli/installazioni soddisfa i molteplici bisogni di utenti privati e pubblici. Una linea nata per soddisfare diverse esigenze di installazione/budget. I suoi numerosi modelli si differenziano per la loro adattabilità

A wide range of models/installations to satisfy the needs of public and private customers. A line created to satisfy different needs of installation/budget. The many models stand out for their adaptability

01 CO-ASCR | 02 CO-PGI | 03 CO-T55E | 04 CO-3PPI |

## CON TELAIO WITH FRAME



01



02



03



04



### CARATTERISTICHE FEATURES

-  ALTEZZA PARETI DOCCIA 185/190  
SHOWER DOOR HEIGHT 185/190
-  SPESSORE LASTRA  
GLASS DEPTH
-  REVERSIBILE  
REVERSIBLE

### INFO TECNICHE TECHNICAL INFORMATION

-  REGOLAZIONE FUORI SQUADRO  
OFF-SQUARE REGULATION
-  ESTENSIBILITÀ 3/6/12  
EXSTENSIBILITY 3/6/12
-  PROFILO MANIGLIA  
HANDLE PROFILE
-  POMOLO  
KNOB
-  CHIUSURA MAGNETICA  
MAGNETIC CLOSURE
-  PROFILO MAGNETICO  
MAGNETIC PROFILE
-  MISURE SPECIALI  
SPECIAL SIZES

### Finiture profili

### Profiles finishing

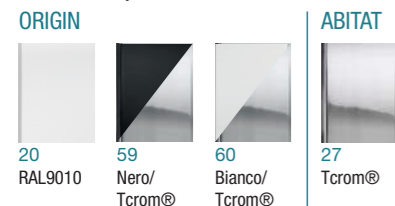

20 RAL9010  
59 Nero/ Tcrom®  
60 Bianco/ Tcrom®  
27 Tcrom®

### Vetri

### Glasses



30 Trasparente  
16 Satinato  
32 Cincillà  
5 Acryl-satin

### in nicchia

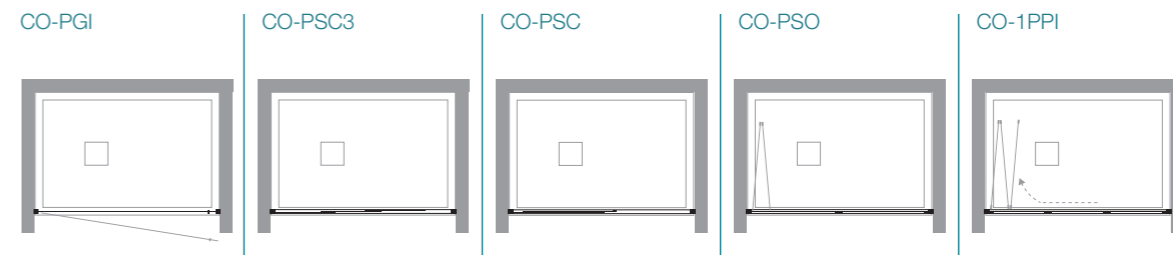

### niche

### ad angolo

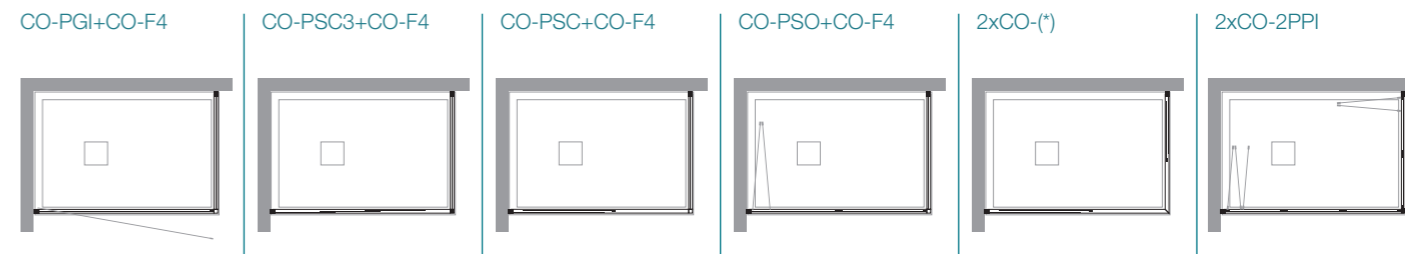

### corner

### a tre lati

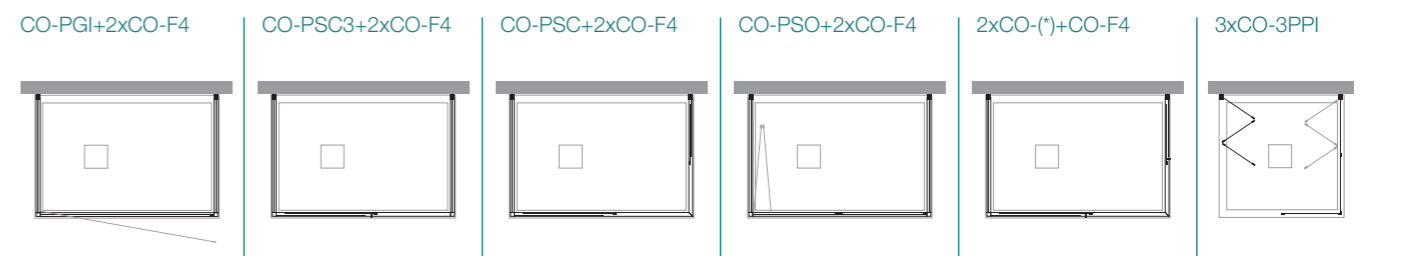

### three sides

### semicircolari

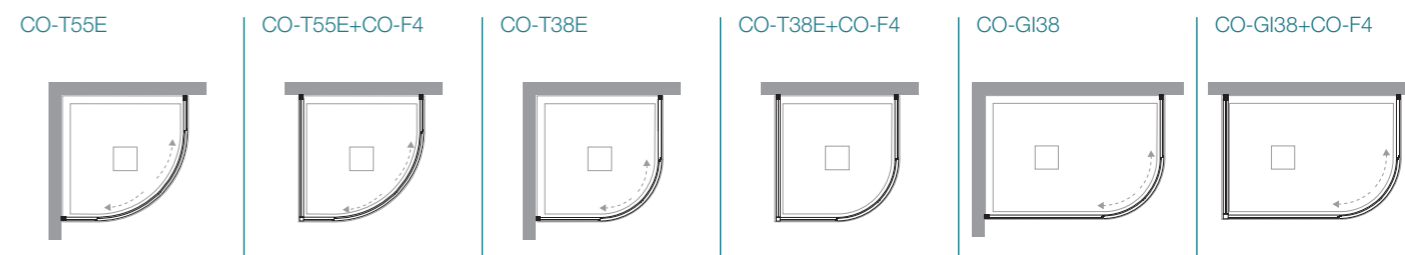

### quadrant

### profili

### profiles

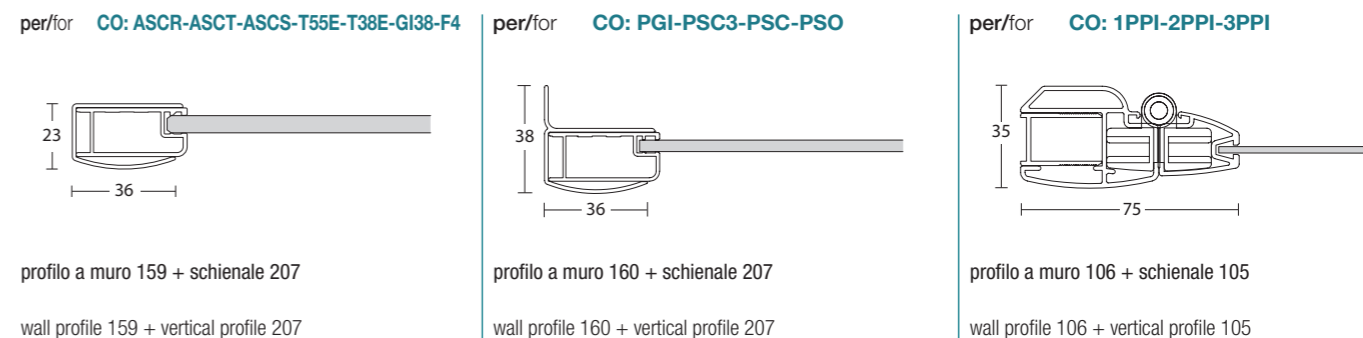

### importante

### important

ordini per pareti doccia speciali senza relativo disegno **NON** vengono prodotti  
orders for special shower walls without related design are **NOT** produced

modelli **CO-2PPI** e **CO-3PPI** NON reversibili  
models **CO-2PPI** and **CO-3PPI** NON-reversible

(\*) ASCR - ASCT - ASCS  
(\*) ASCR - ASCT - ASCS



incluso

included



disponibile

available



## installazioni

ad angolo corner  
CO-ASCR+CO-ASCR

## installations

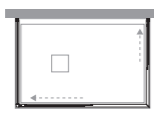
a tre lati three sides  
2xCO-ASCR+CO-F4

## informazioni

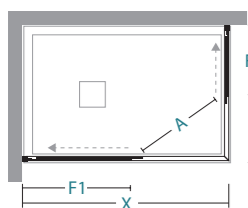
apertura scorrevole  
sliding door

X/Y lunghezza parete doccia\ shower wall length  
A spazio d'entrata\ entrance space  
F1 / F2 lunghezza lato fisso\ fixed side length

## informations

| X/Y     | 68-71 | 71-74 | 74-77 | 77-80 | 83-86 | 87-120 | F1/F2 |   |    |
|---------|-------|-------|-------|-------|-------|--------|-------|---|----|
| 68-71   | A=39  |       |       |       |       |        | 33,5  | 1 | 18 |
| 71-74   | A=40  | A=41  |       |       |       |        | 35    | 1 | 19 |
| 74-77   | A=41  | A=42  | A=43  |       |       |        | 36,5  | 1 | 20 |
| 77-80   | A=42  | A=43  | A=44  | A=46  |       |        | 38    | 1 | 20 |
| 83-86   | A=45  | A=46  | A=47  | A=48  | A=50  |        | 41    | 1 | 22 |
| 87-90   | A=46  | A=47  | A=48  | A=49  | A=51  | A=53   | 43    | 1 | 22 |
| 97-100  | A=46  | A=47  | A=48  | A=49  | A=51  | A=53   | 53    | 1 | 27 |
| 117-120 | A=46  | A=47  | A=48  | A=49  | A=51  | A=53   | 73    | 1 | 31 |

## Misure standard

## Standard sizes

| Codice Code | estensibilità extension | Finiture profili Profiles finishing | 05 | 30 | 32 | 16 |
|-------------|-------------------------|-------------------------------------|----|----|----|----|
| 02A102070   | 68-71                   | origin<br>Tcrom®                    |    |    |    |    |
| 02A102072   | 71-74                   | origin<br>Tcrom®                    |    |    |    |    |
| 02A102076   | 74-77                   | origin<br>Tcrom®                    |    |    |    |    |
| 02A102080   | 77-80                   | origin<br>Tcrom®                    |    |    |    |    |
| 02A102085   | 83-86                   | origin<br>Tcrom®                    |    |    |    |    |
| 02A102090   | 87-90                   | origin<br>Tcrom®                    |    |    |    |    |
| 02A102100   | 97-100                  | origin<br>Tcrom®                    |    |    |    |    |
| 02A102120   | 117-120                 | origin<br>Tcrom®                    |    |    |    |    |

## Misure speciali L / H

## Special sizes L / H

| Codice Code | su misura bespoke | Finiture profili Profiles finishing | 05 | 30 | 32 | 16 |
|-------------|-------------------|-------------------------------------|----|----|----|----|
| 02A109002   | 39 < L < 60       | origin<br>Tcrom®                    |    |    |    |    |
| 02A109002   | 61 < L < 80       | origin<br>Tcrom®                    |    |    |    |    |
| 02A109002   | 81 < L < 100      | origin<br>Tcrom®                    |    |    |    |    |
| 02A109002   | 101 < L < 120     | origin<br>Tcrom®                    |    |    |    |    |

## attenzione

Il prezzo della H speciale va trovato nella tabella Misure speciali L / H in base alla L della parete doccia

Special price for H is to be found in Special sizes L / H as per L needed size

## warning

Il prezzo è inteso per lato

Prices are to be intended for one side

Abbinabile a CO-F4

To match CO-F4

Nelle finiture 60 Bianco e 59 Nero alcuni particolari sono cromati

In the 60 White and 59 Black finishes, some details are chrome-plated

Misure speciali  
Special size

|   |     |        |
|---|-----|--------|
| H | max | 210 cm |
| L | min | 39 cm  |
| L | max | 120 cm |

## supplementi

Profilo di compensazione 3 cm  
Extension profile 3 cm

Set trattamento Neverdrop®  
set Neverdrop®

Sigillante SPARTAN®  
Sealant SPARTAN®

35A010190

36A010004

36B010010

05  
acrilico satin11  
flack12  
reflex16  
satinato24  
nigol25  
flute26  
wave27  
aion28  
fumè brown29  
fumè30  
trasparente31  
extrachiaro32  
cincillà34  
stampato C

origin

abitat

20 RAL9010 / 59 Nero / 60 Bianco

27 Tcrom®

Approfondimenti  
Insights

|  |     |
|--|-----|
| Indice Index                           | 3   |
| Legenda simboli Icons legend           | 11  |
| Profili - Vetri Profiles - Glasses     | 21  |
| Ricambi Spare parts                    | 406 |
| Profili speciali Special profiles      | 434 |
| Schede rilievo misure Measurement form | 444 |

Parete doccia con doppia porta scorrevole a 3 ante  
Shower enclosure with 3-panels double sliding door



incluso

included



disponibile

available



## installazioni

ad angolo corner

CO-ASCT+CO-ASCT



## installations

a tre lati three sides

2xCO-ASCT+CO-F4

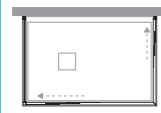

## informazioni

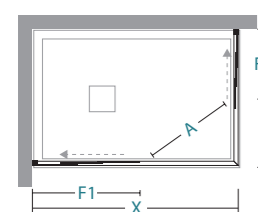
apertura scorrevole  
sliding door

## informations

| X/Y   | 62-65 | 68-71 | 71-74 | 74-77 | 77-80 | 87-90 | F1/F2 |   |    |
|-------|-------|-------|-------|-------|-------|-------|-------|---|----|
| 62-65 | 43    |       |       |       |       |       | 21    | 1 | 17 |
| 68-71 | 46    | 49    |       |       |       |       | 23    | 1 | 18 |
| 71-74 | 48    | 50    | 52    |       |       |       | 24    | 1 | 19 |
| 74-77 | 49    | 52    | 53    | 54    |       |       | 25    | 1 | 20 |
| 77-80 | 51    | 53    | 55    | 56    | 57    |       | 26    | 1 | 22 |
| 87-90 | 56    | 58    | 60    | 61    | 62    | 67    | 29    | 1 | 23 |

X/Y lunghezza parete doccia\ shower wall length

A spazio d'entrata\ entrance space

F1 / F2 lunghezza lato fisso\ fixed side length

## Misure standard

## Standard sizes

| Codice<br>Code | estensibilità<br>extension | Finiture profili<br>Profiles finishing | 05 | 30 | 32 | 16 |
|----------------|----------------------------|--|----|----|----|----|
| 02A040065      | 62-65                      | origin<br>Tcrom®                       |    |    |    |    |
| 02A040070      | 68-71                      | origin<br>Tcrom®                       |    |    |    |    |
| 02A040072      | 71-74                      | origin<br>Tcrom®                       |    |    |    |    |
| 02A040076      | 74-77                      | origin<br>Tcrom®                       |    |    |    |    |
| 02A040080      | 77-80                      | origin<br>Tcrom®                       |    |    |    |    |
| 02A040090      | 87-90                      | origin<br>Tcrom®                       |    |    |    |    |

## Misure speciali L / H

## Special sizes L / H

| Codice<br>Code | su misura<br>bespoke | Finiture profili<br>Profiles finishing | 05 | 30 | 32 | 16 |
|----------------|----------------------|--|----|----|----|----|
| 02A049002      | 43 < L < 60          | origin<br>Tcrom®                       |    |    |    |    |
| 02A049002      | 61 < L < 80          | origin<br>Tcrom®                       |    |    |    |    |
| 02A049002      | 81 < L < 100         | origin<br>Tcrom®                       |    |    |    |    |
| 02A049002      | 101 < L < 120        | origin<br>Tcrom®                       |    |    |    |    |
| 02A049002      | 121 < L < 130        | origin<br>Tcrom®                       |    |    |    |    |

## attenzione

Il prezzo della H speciale va trovato nella tabella Misure speciali L / H in base alla L della parete doccia

Special price for H is to be found in Special sizes L / H as per L needed size

## warning

Il prezzo è inteso per lato  
Prices are to be intended for one side

Abbinabile a CO-F4

To match CO-F4

Nelle finiture 60 Bianco e 59 Nero alcuni particolari sono cromati

In the 60 White and 59 Black finishes, some details are chrome-plated

Approfondimenti  
Insights

|   |     |
|---|-----|
| Indice<br>Index                           | 3   |
| Legenda simboli<br>Icons legend           | 11  |
| Profili - Vetri<br>Profiles - Glasses     | 21  |
| Ricambi<br>Spare parts                    | 406 |
| Profili speciali<br>Special profiles      | 434 |
| Schede rilievo misure<br>Measurement form | 444 |

Misure speciali  
Special size

|   |     |        |
|---|-----|--------|
| H | max | 210 cm |
| L | min | 43 cm  |
| L | max | 130 cm |

## supplementi

## supplements

| Profilo di compensazione 3 cm<br>Extension profile 3 cm | Set trattamento Neverdrop®<br>set Neverdrop® | Sigillante SPARTAN®<br>Sealant SPARTAN® |
|---|--|---|
| 35A010190   | 36A010004                                    | 36B010010                               |

|                |       |        |          |       |       |      |      |            |      |             |             |          |            |
|----------------|-------|--------|----------|-------|-------|------|------|------------|------|-------------|-------------|----------|------------|
| 05             | 11    | 12     | 16       | 24    | 25    | 26   | 27   | 28         | 29   | 30          | 31          | 32       | 34         |
| acrilico satin | flack | reflex | satinato | nigol | flute | wave | alou | fumè brown | fumè | trasparente | extrachiara | cincillà | stampato C |

origin  
20 RAL9010 / 59 Nero / 60 Bianco

abitat  
27 Tcrom®



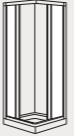



H cm  
190



2,2/4  
mm



REV

incluso



6 cm

included



disponibile



3 cm

available



NEVERDROP



installazioni

ad angolo corner  
CO-ASCS



installations

a tre lati three sides  
CO-ASCS+CO-F4

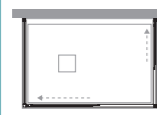

informazioni

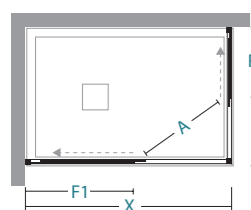

apertura scorrevole  
sliding door

informations

| X/Y   | 68-74 | 74-80 | 80-86 | 86-92 | F1/F2 |  |  |      |
|-------|-------|-------|-------|-------|-------|--|--|------|
| 68-74 | A=36  |       |       |       | 37    |  |  | 1 17 |
| 74-80 |       | A=42  |       |       | 40    |  |  | 1 18 |
| 80-86 | A=44  | A=46  | A=46  |       | 43    |  |  | 1 20 |
| 86-92 | A=46  | A=48  |       | A=50  | 46    |  |  | 1 21 |

X/Y lunghezza parete doccia\ shower wall length  
A spazio d'entrata\ entrance space  
F1 / F2 lunghezza lato fisso\ fixed side length

Misure standard

Standard sizes

| Codice<br>Code | estensibilità<br>extension | Finiture profili<br>Profiles finishing | 05 | 30 | 32 |
|----------------|----------------------------|--|----|----|----|
| 02A071001      | 68-74+80-86                | RAL 9010                               |    |    |    |
| 02A071002      | 68-74+86-92                | RAL 9010                               |    |    |    |
| 02A071003      | 74-80+80-86                | RAL 9010                               |    |    |    |
| 02A071004      | 74-80+86-92                | RAL 9010                               |    |    |    |
| 02A071005      | 74-80+96-102               | RAL 9010                               |    |    |    |
| 02A071006      | 74-80+116-122              | RAL 9010                               |    |    |    |
| 02A071070      | 68-74                      | RAL 9010                               |    |    |    |
| 02A071075      | 74-80                      | RAL 9010                               |    |    |    |
| 02A071085      | 80-86                      | RAL 9010                               |    |    |    |
| 02A071090      | 86-92                      | RAL 9010                               |    |    |    |

attenzione

Abbinabile a CO-F4

warning

To match CO-F4

Disponibilità  
Availability

■ STOCK RAL9010

supplementi

Profilo di compensazione 3 cm  
Extension profile 3 cm

35A010190

supplements

Set trattamento Neverdrop®  
set Neverdrop®

36A010004

Sigillante SPARTAN®  
Sealant SPARTAN®

36B010010

Approfondimenti  
Insights



|   |     |
|---|-----|
| Indice<br>Index                           | 3   |
| Legenda simboli<br>Icons legend           | 11  |
| Profili - Vetri<br>Profiles - Glasses     | 21  |
| Ricambi<br>Spare parts                    | 406 |
| Profili speciali<br>Special profiles      | 434 |
| Schede rilievo misure<br>Measurement form | 444 |

|                         |        |          |       |       |      |       |            |      |             |              |          |            |    |
|-------------------------|--------|----------|-------|-------|------|-------|------------|------|-------------|--------------|----------|------------|----|
| 05                      | 11     | 12       | 16    | 24    | 25   | 26    | 27         | 28   | 29          | 30           | 31       | 32         | 34 |
| acrilico satin<br>flack | reflex | satinato | nigol | flute | wave | alton | fumè brown | fumè | trasparente | extrachiario | cincillà | stampato C |    |

origin

20 RAL9010



incluso

included



disponibile

available



## installazioni

ad angolo corner

CO-ASCV



## installations

## informazioni

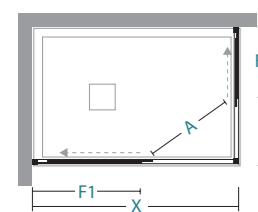
apertura scorrevole  
sliding door

## informations

| X/Y   | 66-78   | 78-90   | F1/F2 |  |  |  |  |   |    |
|-------|---------|---------|-------|--|--|--|--|---|----|
| 66-78 | A=32-49 |         | 38    |  |  |  |  | 1 | 16 |
| 78-90 | A=37-54 | A=40-57 | 44    |  |  |  |  | 1 | 19 |

X/Y lunghezza parete doccia\ shower wall length  
A spazio d'entrata\ entrance space  
F1 / F2 lunghezza lato fisso\ fixed side length

## Misure standard

## Standard sizes

| Codice<br>Code | estensibilità<br>extension | Finiture profili<br>Profiles finishing | 05 |
|----------------|----------------------------|--|----|
| 02A081001      | 66-78+78-90                | RAL 9010                               | ■  |
| 02A081070      | 66-78                      | RAL 9010                               | ■  |
| 02A081090      | 78-90                      | RAL 9010                               | ■  |

## attenzione

## warning

Disponibilità  
Availability

■ STOCK RAL9010

## supplementi

Sigillante SPARTAN®  
Sealant SPARTAN®

36B010010

05 acrilico satin flack 11 reflex 12 reflex 16 satinato 24 nigol 25 flute 26 wave 27 aion 28 fumè brown fumè 29 fumè 30 trasparente 31 extrachiaro 32 cincillà 34 stampato C

origin

20 RAL9010

Approfondimenti  
Insights

|   |     |
|---|-----|
| Indice<br>Index                           | 3   |
| Legenda simboli<br>Icons legend           | 11  |
| Profili - Vetri<br>Profiles - Glasses     | 21  |
| Ricambi<br>Spare parts                    | 406 |
| Profili speciali<br>Special profiles      | 434 |
| Schede rilievo misure<br>Measurement form | 444 |







# Soffietto2000

Parete doccia con porta a soffietto  
Folding door

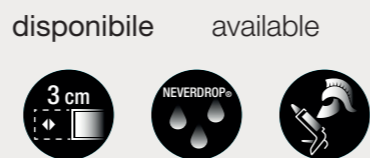
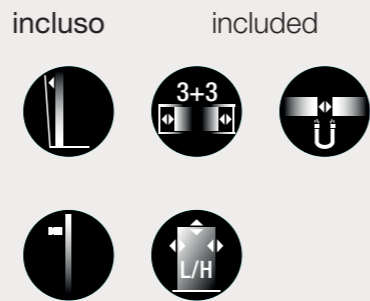
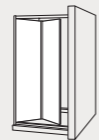

## installazioni

in nicchia niche  
CO-PSO

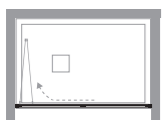

## installations

ad angolo corner  
CO-PSO+CO-F4

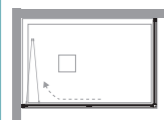

a tre lati three sides  
CO-PSO+2xCO-F4

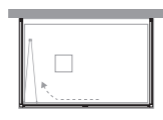

## informazioni

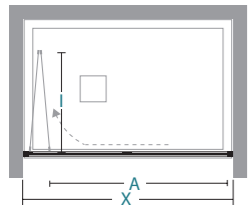

## informations

apertura soffietto  
folding door

|        | X  | A    | I |  |  |  |  |  |   |    |
|--------|----|------|---|--|--|--|--|--|---|----|
| 62-68  | 48 | 29,5 |   |  |  |  |  |  | 1 | 18 |
| 68-74  | 54 | 32,5 |   |  |  |  |  |  | 1 | 19 |
| 74-80  | 60 | 35,5 |   |  |  |  |  |  | 1 | 21 |
| 80-86  | 66 | 38,5 |   |  |  |  |  |  | 1 | 22 |
| 86-92  | 72 | 41,5 |   |  |  |  |  |  | 1 | 24 |
| 94-100 | 80 | 45,5 |   |  |  |  |  |  | 1 | 25 |

X lunghezza parete doccia\ shower wall length  
A spazio d'entrata\ entrance space  
I1 / I2 ingombro interno\ internal dimensions

# CO-PSO

INSTALLAZIONE IN NICCHIA, AD ANGOLO O A TRE LATI  
NICHE, CORNER OR THREE SIDES INSTALLATION

## Misure standard Standard sizes

| Codice Code | estensibilità extension | Finiture profili Profiles finishing | 05 | 30 | 32 | 16 |
|-------------|-------------------------|-------------------------------------|----|----|----|----|
| 02P021065   | 62-68                   | origin<br>Tcrom®                    |    |    |    |    |
| 02P021070   | 68-74                   | origin<br>Tcrom®                    |    |    |    |    |
| 02P021075   | 74-80                   | origin<br>Tcrom®                    |    |    |    |    |
| 02P021085   | 80-86                   | origin<br>Tcrom®                    |    |    |    |    |
| 02P021090   | 86-92                   | origin<br>Tcrom®                    |    |    |    |    |
| 02P021100   | 94-100                  | origin<br>Tcrom®                    |    |    |    |    |

## Misure speciali L / H Special sizes L / H

| Codice Code | su misura bespoke | Finiture profili Profiles finishing | 05 | 30 | 32 | 16 |
|-------------|-------------------|-------------------------------------|----|----|----|----|
| 02P029001   | 44 < L < 60       | origin<br>Tcrom®                    |    |    |    |    |
| 02P029001   | 61 < L < 75       | origin<br>Tcrom®                    |    |    |    |    |
| 02P029001   | 76 < L < 95       | origin<br>Tcrom®                    |    |    |    |    |

## attenzione

Il prezzo della H speciale va trovato nella tabella Misure speciali L / H in base alla L della parete doccia

Special price for H is to be found in Special sizes L / H as per L needed size

## warning

Abbinabile a CO-F4

To match CO-F4

Nelle finiture 60 Bianco e 59 Nero alcuni particolari sono cromati

In the 60 White and 59 Black finishes, some details are chrome-plated

## Misure speciali Special size

|       |        |
|-------|--------|
| H max | 210 cm |
| L min | 44 cm  |
| L max | 95 cm  |

## supplementi

Profilo di compensazione 3 cm  
Extension profile 3 cm

Set trattamento Neverdrop®  
set Neverdrop®

Sigillante SPARTAN®  
Sealant SPARTAN®

35A010190

36A010004

36B010010

| 05                               | 11    | 12     | 16       | 24    | 25    | 26        | 27   | 28         | 29   | 30          | 31          | 32       | 34         |
|----------------------------------|-------|--------|----------|-------|-------|-----------|------|------------|------|-------------|-------------|----------|------------|
| acrilico satin                   | flack | reflex | satinato | nigol | flute | wave      | alon | fumè brown | fumè | trasparente | extrachiara | cincillà | stampato C |
| origin                           |       |        |          |       |       | abitat    |      |            |      |             |             |          |            |
| 20 RAL9010 / 59 Nero / 60 Bianco |       |        |          |       |       | 27 Tcrom® |      |            |      |             |             |          |            |

## Approfondimenti Insights



|  |     |
|--|-----|
| Indice Index                           | 3   |
| Legenda simboli Icons legend           | 11  |
| Profili - Vetri Profiles - Glasses     | 21  |
| Ricambi Spare parts                    | 406 |
| Profili speciali Special profiles      | 434 |
| Schede rilievo misure Measurement form | 444 |

# Elba Tondo

Parete doccia semicircolare con doppia porta scorrevole  
Quadrant shower enclosure with double sliding door



incluso

included



disponibile

available



## installazioni

ad angolo corner

CO-T55E

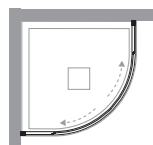

## installations

a tre lati three sides

CO-T55E+CO-F4

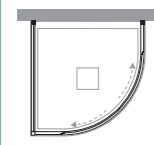

## informazioni

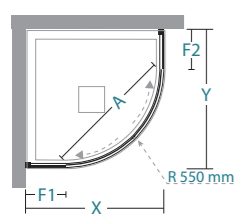

## informations

apertura scorrevole  
sliding door

| X/Y    | A  | F1/F2 |  |  |  |  |  |   |    |
|--------|----|-------|--|--|--|--|--|---|----|
| 77-80  | 43 | 25    |  |  |  |  |  | 1 | 35 |
| 87-90  | 46 | 35    |  |  |  |  |  | 1 | 39 |
| 97-100 | 46 | 45    |  |  |  |  |  | 1 | 43 |

X/Y lunghezza parete doccia\ shower wall length

A spazio d'entrata\ entrance space

F1 / F2 lunghezza lato fisso\ fixed side length

# CO-T55E

INSTALLAZIONE AD ANGOLO O A TRE LATI  
CORNER OR THREE SIDES INSTALLATION

## Misure standard

Standard sizes

| Codice Code | estensibilità extension | Finiture profili Profiles finishing | 05 | 30 | 32 | 16 |
|-------------|-------------------------|-------------------------------------|----|----|----|----|
| 02T011080   | 77-80                   | origin<br>Tcrom®                    |    |    |    |    |
| 02T011090   | 87-90                   | origin<br>Tcrom®                    |    |    |    |    |
| 02T011100   | 97-100                  | origin<br>Tcrom®                    |    |    |    |    |

## Misure speciali L / H

Special sizes L / H

| Codice Code | estensibilità extension | Finiture profili Profiles finishing | 05 | 30 | 32 | 16 |
|-------------|-------------------------|-------------------------------------|----|----|----|----|
| 02T019003   | 60 < L < 80             | origin<br>Tcrom®                    |    |    |    |    |
| 02T019003   | 81 < L < 90             | origin<br>Tcrom®                    |    |    |    |    |
| 02T019003   | 91 < L < 100            | origin<br>Tcrom®                    |    |    |    |    |
| 02T019003   | 101 < L < 120           | origin<br>Tcrom®                    |    |    |    |    |

## attenzione

Il prezzo della H speciale va trovato nella tabella Misure speciali L / H in base alla L della parete doccia

Special price for H is to be found in Special sizes L / H as per L needed size

## warning

Il prezzo delle misure speciali è inteso per lato. Misure speciali in altezza realizzabili solo con lastre Acrilico satin (05)  
Special sizes: prices are to be intended for one side. High special sizes only with acrilico Satin (05)

Abbinabile a CO-F4

To match CO-F4

Installazione su piatto doccia semicircolare raggio 55 cm

Installation on quadrant shower tray radius 55 cm

Nelle finiture 60 Bianco e 59 Nero alcuni particolari sono cromati

In the 60 White and 59 Black finishes, some details are chrome-plated

Approfondimenti  
Insights



|  |     |
|--|-----|
| Indice Index                           | 3   |
| Legenda simboli Icons legend           | 11  |
| Profili - Vetri Profiles - Glasses     | 21  |
| Ricambi Spare parts                    | 406 |
| Profili speciali Special profiles      | 434 |
| Schede rilievo misure Measurement form | 444 |

Misure speciali  
Special size

|       |        |
|-------|--------|
| H max | 210 cm |
| L min | 60 cm  |
| L max | 120 cm |

## supplementi

supplements

Profilo di compensazione 3 cm  
Extension profile 3 cm

Set trattamento Neverdrop®  
set Neverdrop®

Sigillante SPARTAN®  
Sealant SPARTAN®

35A010190 €

36A010004 €

36B010010 €

|                |       |        |          |       |       |      |      |            |      |             |             |          |            |
|----------------|-------|--------|----------|-------|-------|------|------|------------|------|-------------|-------------|----------|------------|
| 05             | 11    | 12     | 16       | 24    | 25    | 26   | 27   | 28         | 29   | 30          | 31          | 32       | 34         |
| acrilico satin | flack | reflex | satinato | nigol | flute | wave | alon | fumè brown | fumè | trasparente | extrachiara | cincillà | stampato C |

origin

abitat

20 RAL9010 / 59 Nero / 60 Bianco

27 Tcrom®

# Elba 75

Parete doccia semicircolare con doppia porta scorrevole  
Quadrant shower enclosure with double sliding door

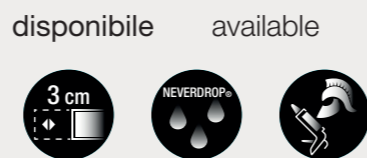
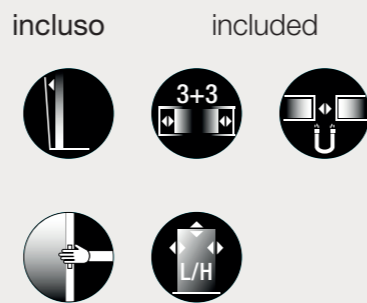

## installazioni

ad angolo corner  
CO-T38E

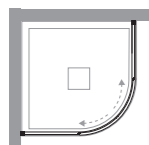

## installations

a tre lati three sides  
CO-T38E+CO-F4

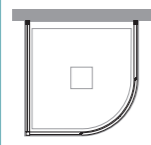

## informazioni

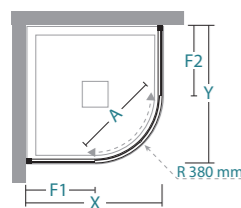

## informations

apertura scorrevole  
sliding door

| X/Y   | A  | F1/F2 |  |  |  |  |  |   |    |
|-------|----|-------|--|--|--|--|--|---|----|
| 72-75 | 40 | 32    |  |  |  |  |  | 1 | 34 |

X / Y lunghezza parete doccia \ shower wall length  
A spazio d'entrata \ entrance space  
F1 / F2 lunghezza lato fisso \ fixed side length

# CO-T38E

INSTALLAZIONE AD ANGOLO O A TRE LATI  
CORNER OR THREE SIDES INSTALLATION

## Misure standard

| Codice Code | estensibilità extension | Finiture profili Profiles finishing | 05 | 30 | 32 | 16 |
|-------------|-------------------------|-------------------------------------|----|----|----|----|
| 02T011075   | 72-75                   | origin Tcrom®                       |    |    |    |    |

## Standard sizes

## Misure speciali L / H

| Codice Code | estensibilità extension | Finiture profili Profiles finishing | 05 | 30 | 32 | 16 |
|-------------|-------------------------|-------------------------------------|----|----|----|----|
| 02T019002   | 55 < L < 80             | origin Tcrom®                       |    |    |    |    |
| 02T019002   | 81 < L < 90             | origin Tcrom®                       |    |    |    |    |
| 02T019002   | 91 < L < 100            | origin Tcrom®                       |    |    |    |    |
| 02T019002   | 101 < L < 120           | origin Tcrom®                       |    |    |    |    |

## Special sizes L / H

## attenzione

Il prezzo della H speciale va trovato nella tabella Misure speciali L / H in base alla L della parete doccia.

Special price for H is to be found in Special sizes L / H as per L needed size

## warning

Il prezzo delle misure speciali è inteso per lato. Misure speciali in altezza realizzabili solo con lastre Acrilico satin (05)  
Special sizes: prices are to be intended for one side. High special sizes only with acrilico Satin (05)

Abbinabile a CO-F4

To match CO-F4

Installazione su piatto doccia semicircolare 75x75 raggio 38 cm

Installation on quadrant shower tray 75x75 radius 38 cm

Nelle finiture 60 Bianco e 59 Nero alcuni particolari sono cromati

In the 60 White and 59 Black finishes, some details are chrome-plated

Approfondimenti Insights



|  |     |
|--|-----|
| Indice Index                           | 3   |
| Legenda simboli Icons legend           | 11  |
| Profili - Vetri Profiles - Glasses     | 21  |
| Ricambi Spare parts                    | 406 |
| Profili speciali Special profiles      | 434 |
| Schede rilievo misure Measurement form | 444 |

| Misure speciali Special size |        |  |  |
|------------------------------|--------|--|--|
| H max                        | 210 cm |  |  |
| L min                        | 55 cm  |  |  |
| L max                        | 120 cm |  |  |

## supplementi

| Profilo di compensazione 3 cm Extension profile 3 cm | Set trattamento Neverdrop® set Neverdrop® | Sigillante SPARTAN® Sealant SPARTAN® |  |
|--|---|--------------------------------------|--|
| 35A010190  | 36A010004                                 | 36B010010                            |  |

## supplements

| 05                               | 11        | 12     | 16       | 24    | 25    | 26   | 27   | 28         | 29   | 30          | 31           | 32       | 34         |
|----------------------------------|-----------|--------|----------|-------|-------|------|------|------------|------|-------------|--------------|----------|------------|
| acrilico satin                   | flack     | reflex | satinato | nigol | flute | wave | alon | fumè brown | fumè | trasparente | extrachiario | cincillà | stampato C |
| origin                           | abitat    |        |          |       |       |      |      |            |      |             |              |          |            |
| 20 RAL9010 / 59 Nero / 60 Bianco | 27 Tcrom® |        |          |       |       |      |      |            |      |             |              |          |            |

# Elba Giro

Parete doccia semicircolare con doppia porta scorrevole  
Quadrant shower enclosure with double sliding door

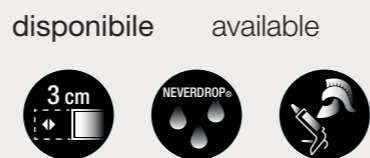
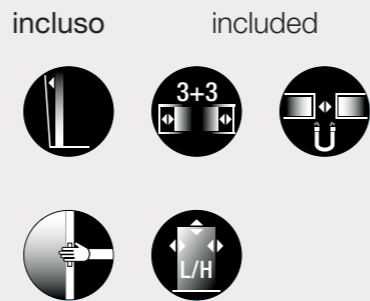
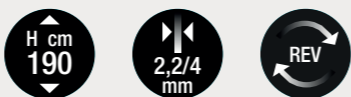

## installazioni

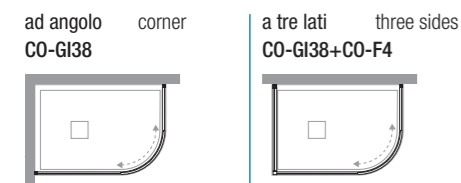

## informazioni

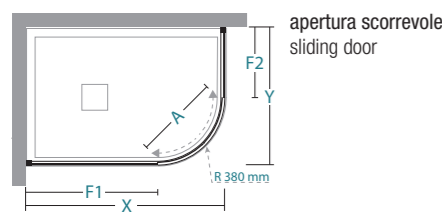

X / Y lunghezza parete doccia \ shower wall length  
A spazio d'entrata \ entrance space  
F1 / F2 lunghezza lato fisso \ fixed side length

| X      | Y     | A    | F1 | F2 |  |  |  |   |    |
|--------|-------|------|----|----|--|--|--|---|----|
| 87-90  | 67-70 | 40,5 | 48 | 28 |  |  |  | 1 | 36 |
| 97-100 | 77-80 | 40,5 | 58 | 38 |  |  |  | 1 | 41 |

# CO-GI38

INSTALLAZIONE AD ANGOLO O A TRE LATI  
CORNER OR THREE SIDES INSTALLATION

## Misure standard Standard sizes

| Codice Code | estensibilità extension | Finiture profili Profiles finishing | 05 | 30 | 32 | 16 |
|-------------|-------------------------|-------------------------------------|----|----|----|----|
| 02T011001   | 67-70+87-90             | origin Tcrom®                       |    |    |    |    |
| 02T011002   | 77-80+97-100            | origin Tcrom®                       |    |    |    |    |

## Misure speciali L / H Special sizes L / H

| Codice Code | estensibilità extension | Finiture profili Profiles finishing | 05 | 30 | 32 | 16 |
|-------------|-------------------------|-------------------------------------|----|----|----|----|
| 02T019001   | 55 < L < 80             | origin Tcrom®                       |    |    |    |    |
| 02T019001   | 81 < L < 90             | origin Tcrom®                       |    |    |    |    |
| 02T019001   | 91 < L < 100            | origin Tcrom®                       |    |    |    |    |
| 02T019001   | 101 < L < 120           | origin Tcrom®                       |    |    |    |    |

## attenzione

Il prezzo della H speciale va trovato nella tabella Misure speciali L / H in base alla L della parete doccia

Special price for H is to be found in Special sizes L / H as per L needed size

## warning

Il prezzo delle misure speciali è inteso per lato. Misure speciali in altezza realizzabili solo con lastre Acrilico satin (05)  
Special sizes: prices are to be intended for one side. High special sizes only with acrilico Satin (05)

Abbinabile a CO-F4

To match CO-F4

Installazione su piatto doccia semicircolare raggio 38 cm

Installation on quadrant shower tray radius 38 cm

Nelle finiture 60 Bianco e 59 Nero alcuni particolari sono cromati

In the 60 White and 59 Black finishes, some details are chrome-plated

Approfondimenti Insights



|  |     |
|--|-----|
| Indice Index                           | 3   |
| Legenda simboli Icons legend           | 11  |
| Profili - Vetri Profiles - Glasses     | 21  |
| Ricambi Spare parts                    | 406 |
| Profili speciali Special profiles      | 434 |
| Schede rilievo misure Measurement form | 444 |

## Misure speciali Special size

|   |     |        |
|---|-----|--------|
| H | max | 210 cm |
| L | min | 55 cm  |
| L | max | 120 cm |

## supplementi

Profilo di compensazione 3 cm Extension profile 3 cm

35A010190

Set trattamento Neverdrop® set Neverdrop®

36A010004

## supplements

Sigillante SPARTAN® Sealant SPARTAN®

36B010010

|                                  |           |        |          |       |       |      |      |            |      |             |              |          |            |
|----------------------------------|-----------|--------|----------|-------|-------|------|------|------------|------|-------------|--------------|----------|------------|
| 05                               | 11        | 12     | 16       | 24    | 25    | 26   | 27   | 28         | 29   | 30          | 31           | 32       | 34         |
| acrilico satin                   | flack     | reflex | satinato | nigol | flute | wave | alon | fumè brown | fumè | trasparente | extrachiario | cincillà | stampato C |
| origin                           | abitat    |        |          |       |       |      |      |            |      |             |              |          |            |
| 20 RAL9010 / 59 Nero / 60 Bianco | 27 Tcrom® |        |          |       |       |      |      |            |      |             |              |          |            |







H cm  
190





2,2  
mm



REV

incluso

included



disponibile



available



### installazioni

ad angolo corner  
CO-T61

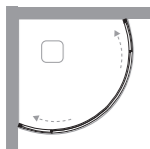

### informazioni

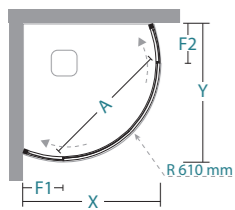

**X / Y** lunghezza parete doccia \ shower wall length  
**A** spazio d'entrata \ entrance space  
**F1 / F2** lunghezza lato fisso \ fixed side length

### installations

### informations

| X/Y   | A  | F1/F2 |  |  |  |  |  |  |  |
|-------|----|-------|--|--|--|--|--|---|---|
| 77-80 | 51 | 36    |  |  |  |  |  | 1   | 19  |

### Misure standard

### Standard sizes

| Codice Code | estensibilità extension | Finiture profili Profiles finishing | 05  |
|-------------|-------------------------|-------------------------------------|---|
| 02T071080   | 77-80                   | RAL 9010                            |  |

### attenzione

Installazione su piatto doccia semicircolare raggio 61 cm

Installation on quadrant shower tray radius 61 cm

Disponibilità Availability

 STOCK RAL9010

### warning

### supplementi

Profilo di compensazione 3 cm  
Extension profile 3 cm

Sigillante SPARTAN®  
Sealant SPARTAN®

35A010190

36B010010

|                |           |           |           |           |           |           |           |            |           |             |             |           |            |
|----------------|-----------|-----------|-----------|-----------|-----------|-----------|-----------|------------|-----------|-------------|-------------|-----------|------------|
| <b>05</b>      | <b>11</b> | <b>12</b> | <b>16</b> | <b>24</b> | <b>25</b> | <b>26</b> | <b>27</b> | <b>28</b>  | <b>29</b> | <b>30</b>   | <b>31</b>   | <b>32</b> | <b>34</b>  |
| acrilico satin | flack     | reflex    | satinato  | nigol     | flute     | wave      | alon      | fumè brown | fumè      | trasparente | extrachiaro | cincillà  | stampato C |

### origin

20 RAL9010

### Approfondimenti Insights



|  |     |
|--|-----|
| Indice Index                           | 3   |
| Legenda simboli Icons legend           | 11  |
| Profili - Vetri Profiles - Glasses     | 21  |
| Ricambi Spare parts                    | 406 |
| Profili speciali Special profiles      | 434 |
| Schede rilievo misure Measurement form | 444 |

# Spazio 100

Parete doccia con porta pieghevole  
Folding door

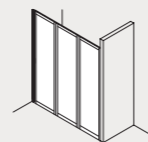

incluso included

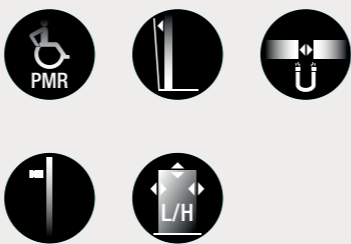

disponibile available



## installazioni

in nicchia niche  
CO-1PPI

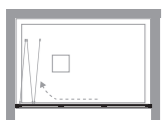

## installations

ad angolo corner  
CO-1PPI+CO-F4 special



## informazioni

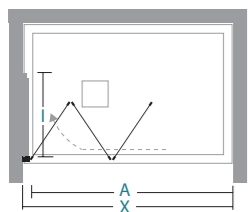

apertura pieghevole  
folding door

X lunghezza parete doccia\ shower wall length  
A spazio d'entrata\ entrance space  
I1 ingombro interno\ internal dimensions

# CO-1PPI

INSTALLAZIONE IN NICCHIA O AD ANGOLO  
NICHE OR CORNER INSTALLATION

## Misure speciali L / H Special sizes L / H

| Codice Code | su misura bespoke | Finiture profili Profiles finishing | 05 |
|-------------|-------------------|-------------------------------------|----|
| 02C029100   | 40 < L < 65       | RAL 9010<br>Tcrom®                  |    |
| 02C029100   | 66 < L < 79       | RAL 9010<br>Tcrom®                  |    |
| 02C029100   | 80 < L < 89       | RAL 9010<br>Tcrom®                  |    |
| 02C029100   | 90 < L < 99       | RAL 9010<br>Tcrom®                  |    |
| 02C029100   | 100 < L < 109     | RAL 9010<br>Tcrom®                  |    |
| 02C029100   | 110 < L < 119     | RAL 9010<br>Tcrom®                  |    |
| 02C029100   | 120 < L < 129     | RAL 9010<br>Tcrom®                  |    |
| 02C029100   | 130 < L < 140     | RAL 9010<br>Tcrom®                  |    |

## attenzione

Il prezzo della H speciale va trovato nella tabella Misure speciali L / H in base alla L della parete doccia

Special price for H is to be found in Special sizes L / H as per L needed size

## warning

Per misure < 90 cm la Parete doccia si compone di due ante

For < 90 cm glass you will have two doors

Installazione a pavimento. Per installazione su piatto doccia vedi scheda rilievo misure

Floor installation. For installation on shower tray see dimension relief sheet

La scheda di misurazione è importante e si trova sul sito web www.tda.it.

The measurement sheet is important and can be found on the website www.tda.it.

## Misure speciali Special size

|   |     |        |
|---|-----|--------|
| H | max | 210 cm |
| L | min | 40 cm  |
| L | max | 140 cm |

## supplementi

Profilo di compensazione 3 cm  
Extension profile 3 cm

€

35A019001

Profilo di tenuta acqua  
Sealed profile

€

35M069001

## supplements

Sigillante SPARTAN®  
Sealant SPARTAN®

€

36B010010

|                |       |        |          |       |       |      |      |            |      |             |              |          |            |
|----------------|-------|--------|----------|-------|-------|------|------|------------|------|-------------|--------------|----------|------------|
| 05             | 11    | 12     | 16       | 24    | 25    | 26   | 27   | 28         | 29   | 30          | 31           | 32       | 34         |
| acrilico satin | flack | reflex | satinato | nigol | flute | wave | alon | fumè brown | fumè | trasparente | extrachiario | cincillà | stampato C |

origin

20 RAL9010

abitat

27 Tcrom®

## Approfondimenti Insights



|  |     |
|--|-----|
| Indice Index                           | 3   |
| Legenda simboli Icons legend           | 11  |
| Profili - Vetri Profiles - Glasses     | 21  |
| Ricambi Spare parts                    | 406 |
| Profili speciali Special profiles      | 434 |
| Schede rilievo misure Measurement form | 444 |

# Spazio 200

Parete doccia con porta pieghevole  
Folding door



incluso

included



disponibile

available



## installazioni

ad angolo corner  
2 x CO-2PPI

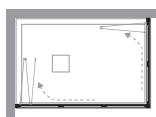

## installations

## informazioni

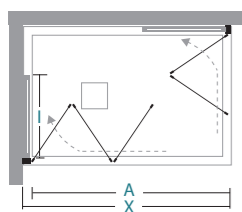

apertura pieghevole  
folding door

## informations

X lunghezza parete doccia\ shower wall length  
A spazio d'entrata\ entrance space  
I1 ingombro interno\ internal dimensions

# CO-2PPI

INSTALLAZIONE IN NICCHIA O AD ANGOLO  
NICHE OR CORNER INSTALLATION

## Misure speciali L / H Special sizes L / H

| Codice Code | su misura bespoke | Finiture profili Profiles finishing | 05 |
|-------------|-------------------|-------------------------------------|----|
| 02C029200   | 40 < L < 65       | RAL 9010<br>Tcrom®                  |    |
| 02C029200   | 66 < L < 79       | RAL 9010<br>Tcrom®                  |    |
| 02C029200   | 80 < L < 89       | RAL 9010<br>Tcrom®                  |    |
| 02C029200   | 90 < L < 99       | RAL 9010<br>Tcrom®                  |    |
| 02C029200   | 100 < L < 109     | RAL 9010<br>Tcrom®                  |    |
| 02C029200   | 110 < L < 119     | RAL 9010<br>Tcrom®                  |    |
| 02C029200   | 120 < L < 129     | RAL 9010<br>Tcrom®                  |    |
| 02C029200   | 130 < L < 140     | RAL 9010<br>Tcrom®                  |    |

## attenzione

Il prezzo della H speciale va trovato nella tabella Misure speciali L / H in base alla L della parete doccia

Special price for H is to be found in **Special sizes L / H** as per L needed size

## warning

Per misure > 100 cm la Parete doccia si compone di tre ante

For > 100 cm glass you will have three doors

Installazione a pavimento. Per installazione su piatto doccia vedi scheda rilievo misure

Floor installation. For installation on shower tray see dimension relief sheet

Specificare eventuali esigenze di impaccettamento delle porte diverso dallo standard

Specify any different way of packing needed

La scheda di misurazione è importante e si trova sul sito web [www.tda.it](http://www.tda.it).

The measurement sheet is important and can be found on the website [www.tda.it](http://www.tda.it).

Approfondimenti  
Insights



|  |     |
|--|-----|
| Indice Index                           | 3   |
| Legenda simboli Icons legend           | 11  |
| Profili - Vetri Profiles - Glasses     | 21  |
| Ricambi Spare parts                    | 406 |
| Profili speciali Special profiles      | 434 |
| Schede rilievo misure Measurement form | 444 |

| Misure speciali Special size |        |
|------------------------------|--------|
| H max                        | 210 cm |
| L min                        | 40 cm  |
| L max                        | 140 cm |

## supplementi

| Profilo di tenuta acqua Sealed profile | Raccordi Connection set | Sigillante SPARTAN® Sealant SPARTAN® |
|--|-------------------------|--------------------------------------|
| 35M069001                              | 37R019051               | 36B010010                            |

## supplements

| 05                   | 11        | 12     | 16       | 24    | 25    | 26   | 27   | 28         | 29   | 30          | 31           | 32       | 34         |
|----------------------|-----------|--------|----------|-------|-------|------|------|------------|------|-------------|--------------|----------|------------|
| acrilico satin flack | reflex    | reflex | satinato | nigol | flute | wave | alon | fumè brown | fumè | trasparente | extrachiario | cincillà | stampato C |
| origin               | abitat    |        |          |       |       |      |      |            |      |             |              |          |            |
| 20 RAL9010           | 27 Tcrom® |        |          |       |       |      |      |            |      |             |              |          |            |

# Spazio 300

Parete doccia con porta pieghevole  
Folding door

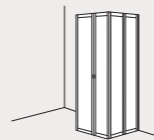

incluso

included



disponibile

available



## installazioni

a tre lati three sides  
3 x CO-3PPI

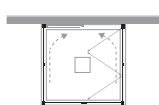

## installations

## informazioni

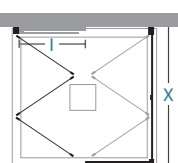

apertura pieghevole  
folding door

## informations

X lunghezza parete doccia\ shower wall length  
I1 ingombro interno\ internal dimensions

# CO-3PPI

PER INSTALLAZIONE A 3 LATI  
FOR 3 SIDES INSTALLATION

## Misure speciali L / H

## Special sizes L / H

| Codice Code | su misura bespoke | Finiture profili Profiles finishing | 05 |
|-------------|-------------------|-------------------------------------|----|
| 02C029300   | 40 < L < 65       | RAL 9010<br>Tcrom®                  |    |
| 02C029300   | 66 < L < 79       | RAL 9010<br>Tcrom®                  |    |
| 02C029300   | 80 < L < 89       | RAL 9010<br>Tcrom®                  |    |
| 02C029300   | 90 < L < 99       | RAL 9010<br>Tcrom®                  |    |
| 02C029300   | 100 < L < 109     | RAL 9010<br>Tcrom®                  |    |
| 02C029300   | 110 < L < 120     | RAL 9010<br>Tcrom®                  |    |

## attenzione

Il prezzo della H speciale va trovato nella tabella Misure speciali L / H in base alla L della parete doccia

Special price for H is to be found in **Special sizes L / H** as per L needed size

## warning

Il prezzo è inteso per lato

Prices are to be intended for one side

Installazione a pavimento. Per installazione su piatto doccia vedi scheda rilievo misure

Floor installation. For installation on shower tray see dimension relief sheet

Specificare eventuali esigenze di impaccettamento delle porte diverso dallo standard

Specify any different way of packing needed

La scheda di misurazione è importante e si trova sul sito web [www.tda.it](http://www.tda.it).

The measurement sheet is important and can be found on the website [www.tda.it](http://www.tda.it).

Approfondimenti Insights



|  |     |
|--|-----|
| Indice Index                           | 3   |
| Legenda simboli Icons legend           | 11  |
| Profili - Vetri Profiles - Glasses     | 21  |
| Ricambi Spare parts                    | 406 |
| Profili speciali Special profiles      | 434 |
| Schede rilievo misure Measurement form | 444 |

| Misure speciali Special size |        |  |
|------------------------------|--------|--|
| H max                        | 210 cm |  |
| L min                        | 40 cm  |  |
| L max                        | 120 cm |  |

## supplementi

Profilo di tenuta acqua Sealed profile

Raccordi Connection set

Sigillante SPARTAN® Sealant SPARTAN®

35M069001

37R019051

36B010010

| 05                   | 11        | 12     | 16       | 24    | 25    | 26   | 27   | 28         | 29   | 30          | 31          | 32       | 34         |
|----------------------|-----------|--------|----------|-------|-------|------|------|------------|------|-------------|-------------|----------|------------|
| acrilico satin flack | reflex    | reflex | satinato | nigol | flute | wave | alon | fumè brown | fumè | trasparente | extrachiaro | cincillà | stampato C |
| origin               | abitat    |        |          |       |       |      |      |            |      |             |             |          |            |
| 20 RAL9010           | 27 Tcrom® |        |          |       |       |      |      |            |      |             |             |          |            |





Soprasasca  
profilo Tcrom® / vetro Trasparente

Bathtub  
Tcrom® profile / Transparent glass

## SOPRAVASCA

Le pareti doccia di questa specifica serie rispondono alle esigenze legate alla vasca da bagno. Minimali e rilassanti quelle ispirate alle serie Italo, Mindy e Mork, estremamente adattabili quelle ispirate alla serie Comfort. Schermi, pieghevoli e chiusure integrali risolvono ogni particolarità di installazione

The shower walls in this specific series respond to the needs of the bathtub. Minimal and relaxing those inspired by the Italo, Mindy and Mork series, extremely adaptable those inspired by the Comfort series. Screens, folding and integral closures solve every installation peculiarity



01



02



03

**01** sistema di supporti abbinabili per combinazioni angolari | **02** tappi di chiusura per profili verticali | **03** perno di rotazione inferiore con protezione laterale |

**01** compatible supports for corner combinations | **02** caps for vertical profiles | **03** lower pivot pin with side protection |



### CARATTERISTICHE FEATURES

**H**  
cm ALTEZZA PARETI DOCCIA 140/150  
SHOWER DOOR HEIGHT 140/150

**SP**  
mm SPESSORE LASTRA 2,2/4/6  
GLASS DEPTH 2,2/4/6

**REV**  
REVERSIBILE  
REVERSIBLE

### INFO TECNICHE TECHNICAL INFORMATION

**L**  
REGOLAZIONE FUORI SQUADRO  
OFF-SQUARE REGULATION

**EST**  
cm ESTENSIBILITÀ 1/2/6  
EXSTENSIBILITY 1/2/6

**R**  
ROTAZIONE A CAMMA  
CAM ROTATION

**M**  
PROFILO MAGNETICO  
MAGNETIC PROFILE

**L/H**  
MISURE SPECIALI  
SPECIAL SIZES

**D**  
DECOGRAFIA  
DECOPRINTING

### Finiture profili

#### ORIGIN

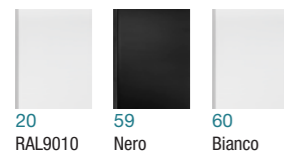

### Profiles finishing

#### ABITAT



#### VOGUE

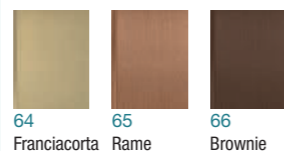
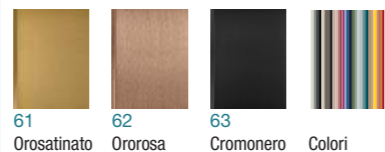

### Vetri

### Glasses



### installazioni previste allowed installations

#### a un lato

IT-SV



IT-SV+B-6 speciale



#### one side

MO-SV

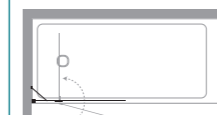

MI-SV



CO-SVF

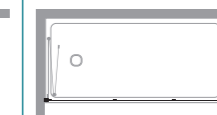

#### a due lati

CO-VSC



CO-SVF+CO-SVFF



#### two sides

CO-VSC+CO-VSCF



#### a tre lati

CO-VSC+2xCO-VSCF

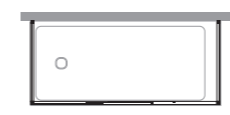

#### three sides

### profili

### profiles

per/for **CO: SVFF-VSCF-VSC**

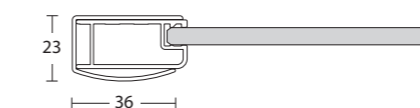

profilo a muro 160 + schienale 207

wall profile 160 + vertical profile 207

per/for **IT-SV**

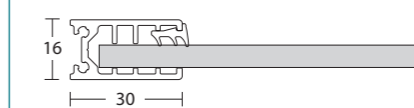

profilo a muro 1135 + guarnizione 78x10

wall profile 1135 + seal 78x10

per/for **MO-SV / MI-SV**

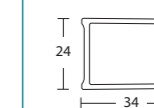

profilo a muro 1125

wall profile 1125

### importante

### important

ordini per pareti doccia speciali senza relativo disegno **NON** vengono prodotti

orders for special shower walls without related design are **NOT** produced

modelli **MO-SV** e **MI-SV** NON reversibili

models **MO-SV** and **MI-SV** NON-reversible

trattamento NEVERDROP® incluso per i modelli **IT-SV**, **MO-SV** e **MI-SV**

NEVERDROP® treatment included for **IT-SV**, **MO-SV** and **MI-SV**





SX  
LH

DX  
RH

incluso

included

disponibile

available

installazioni

su vasca for bathtub  
MO-SV

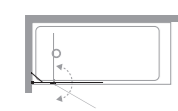

informazioni

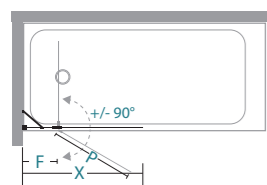

X lunghezza parete doccia \ shower wall length  
F lunghezza lato fisso \ fixed side length  
P lunghezza porta \ door length

installations

informations

|         | X  | F  | P |  |  |  |  |  |   |    |
|---------|----|----|---|--|--|--|--|--|---|----|
| 94-96   | 30 | 62 |   |  |  |  |  |  | 1 | 26 |
| 99-101  | 30 | 67 |   |  |  |  |  |  | 1 | 27 |
| 104-106 | 30 | 72 |   |  |  |  |  |  | 1 | 29 |

Misure standard

| Codice SX<br>LH Code | Codice DX<br>RH Code | estensibilità<br>extension | Finiture profili<br>Profiles finishing | 30 | 32 | 16 | 29 | 28 | 12 |
|----------------------|----------------------|----------------------------|--|----|----|----|----|----|----|
| 08V010094            | 08V020094            | 94-96                      | origin<br>abitat<br>vogue              |    |    |    |    |    |    |
| 08V010099            | 08V020099            | 99-101                     | origin<br>abitat<br>vogue              |    |    |    |    |    |    |
| 08V010104            | 08V020104            | 104-106                    | origin<br>abitat<br>vogue              |    |    |    |    |    |    |

Standard sizes

Misure speciali L / H

| Codice SX<br>LH Code | Codice DX<br>RH Code | su misura<br>bespoke | Finiture profili<br>Profiles finishing | 30 | 32 | 16 | 29 | 28 | 27 | 12 |
|----------------------|----------------------|----------------------|--|----|----|----|----|----|----|----|
| 08V019001            | 08V029001            | 50 < L < 60          | origin<br>abitat<br>vogue              |    |    |    |    |    |    |    |
| 08V019001            | 08V029001            | 61 < L < 100         | origin<br>abitat<br>vogue              |    |    |    |    |    |    |    |
| 08V019001            | 08V029001            | 101 < L < 140        | origin<br>abitat<br>vogue              |    |    |    |    |    |    |    |

Special sizes L / H

attenzione

Il prezzo della H speciale va trovato nella tabella Misure speciali L / H in base alla L della parete doccia

Special price for H is to be found in Special sizes L / H as per L needed size

Misure speciali  
Special size

|   |     |        |
|---|-----|--------|
| H | max | 160 cm |
| L | min | 50 cm  |
| L | max | 140 cm |

supplementi

Decografia  
Decoprinting

Sigillante SPARTAN®  
Sealant SPARTAN®

€

€

per codice  
for code

36B010010

| 05             | 11    | 12     | 16       | 24    | 25    | 26   | 27   | 28         | 29   | 30          | 31           | 32       | 34         |
|----------------|-------|--------|----------|-------|-------|------|------|------------|------|-------------|--------------|----------|------------|
| acrilico satin | flack | reflex | satinato | nigol | flute | wave | alon | fumè brown | fumè | trasparente | extrachiario | cincillà | stampato C |

origin

abitat

vogue

59 Nero / 60 Bianco

27 Tcrom® / 21 Tinox® / 22 Tbronze®

61 Orosatinato / 62 Ororosa / 63 Cromonero / 64 Franciacorta / 65 Rame / 66 Brownie / Colori

warning

Optical e Terra - decografia per: vetro Trasparente, Misure standard e speciali, max 135 cm L

Optical and Terra - decoprinting for: glass Trasparente, Standard and Special sizes, max 135 cm L

Incluso: supporto di rinforzo regolabile e snodato

Included: adjustable, articulated supporting bar

Approfondimenti  
Insights



|   |     |
|---|-----|
| Indice<br>Index                           | 3   |
| Legenda simboli<br>Icons legend           | 11  |
| Profili - Vetri<br>Profiles - Glasses     | 21  |
| Ricambi<br>Spare parts                    | 406 |
| Profili speciali<br>Special profiles      | 434 |
| Schede rilievo misure<br>Measurement form | 444 |



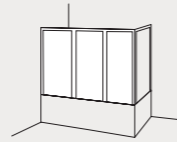

incluso included

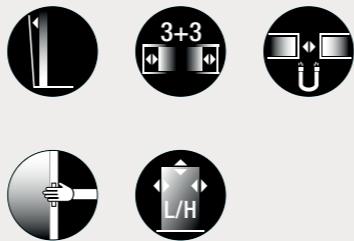

disponibile available



installazioni

su vasca for bathtub  
CO-VSC



installations

su vasca for bathtub  
CO-VSC+CO-VSCF



su vasca for bathtub  
CO-VSC+2xCO-VSCF



informazioni

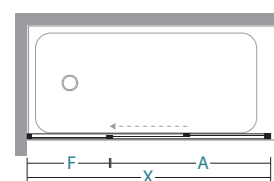

apertura scorrevole  
sliding door

informations

| X       | F  | A   |  |  |  |  |  |  |  |  |
|---------|----|-----|--|--|--|--|--|--|--|--|
| 165-171 | 60 | 100 |  |  |  |  |  |  |  |  |

X lunghezza parete doccia\ shower wall length  
F lunghezza lato fisso\ fixed side length

Misure standard Standard sizes

| Codice Code | estensibilità extension | Finiture profili Profiles finishing | 05 | 30 | 32 |
|-------------|-------------------------|-------------------------------------|----|----|----|
| 02V050165   | 165-171                 | origin Tcrom®                       |    |    |    |

Misure speciali L / H Special sizes L / H

| Codice Code | su misura bespoke | Finiture profili Profiles finishing | 05 | 30 | 32 |
|-------------|-------------------|-------------------------------------|----|----|----|
| 02V059001   | 99 < L < 130      | origin Tcrom®                       |    |    |    |
| 02V059001   | 131 < L < 160     | origin Tcrom®                       |    |    |    |
| 02V059001   | 161 < L < 190     | origin Tcrom®                       |    |    |    |
| 02V059001   | 191 < L < 207     | origin Tcrom®                       |    |    |    |

attenzione

Il prezzo della H speciale va trovato nella tabella Misure speciali L / H in base alla L della parete doccia

Special price for H is to be found in Special sizes L / H as per L needed size

warning

Nelle finiture 60 Bianco e 59 Nero alcuni particolari sono cromati

In the 60 White and 59 Black finishes, some details are chrome-plated

Misure speciali Special size

|   |     |        |
|---|-----|--------|
| H | max | 160 cm |
| L | min | 99 cm  |
| L | max | 207 cm |

supplementi

Profilo di compensazione 3 cm  
Extension profile 3 cm

35A010150

Set trattamento Neverdrop®  
set Neverdrop®

36A010004

supplements

Sigillante SPARTAN®  
Sealant SPARTAN®

36B010010

|                |       |        |          |       |       |      |      |            |      |             |             |          |            |
|----------------|-------|--------|----------|-------|-------|------|------|------------|------|-------------|-------------|----------|------------|
| 05             | 11    | 12     | 16       | 24    | 25    | 26   | 27   | 28         | 29   | 30          | 31          | 32       | 34         |
| acrilico satin | flack | reflex | satinato | nigol | flute | wave | alou | fumè brown | fumè | trasparente | extrachiaro | cincillà | stampato C |

origin 20 RAL9010 / 59 Nero / 60 Bianco  
abitat 27 Tcrom®

Approfondimenti Insights



|  |     |
|--|-----|
| Indice Index                           | 3   |
| Legenda simboli Icons legend           | 11  |
| Profili - Vetri Profiles - Glasses     | 21  |
| Ricambi Spare parts                    | 406 |
| Profili speciali Special profiles      | 434 |
| Schede rilievo misure Measurement form | 444 |



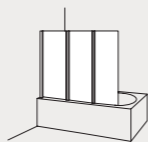

incluso

included



disponibile

available



## installazioni

su vasca for bathtub  
CO-SVF

## installations

su vasca for bathtub  
CO-SVF+CO-SVFF

## informazioni

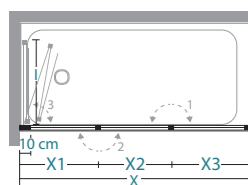
apertura pieghevole  
folding door

## informations

| X   | X1 | X2 | X3 | I  |  |  |  |  |  |
|-----|----|----|----|----|--|--|--|--|--|
| 140 | 45 | 45 | 45 | 49 |  |  |  |  |  |

- X lunghezza parete doccia\ shower wall length  
X1 lunghezza porta\ door length  
X2 lunghezza porta\ door length  
X3 lunghezza porta\ door length  
I ingombro interno\ internal dimensions

## Misure standard

## Standard sizes

| Codice<br>Code | estensibilità<br>extension | Finiture profili<br>Profiles finishing | 05 |
|----------------|----------------------------|--|----|
| 02V020140      | 140                        | RAL 9010                               |    |

## Misure speciali L / H

## Special sizes L / H

| Codice<br>Code | su misura<br>bespoke | Finiture profili<br>Profiles finishing | 05 |
|----------------|----------------------|--|----|
| 02V029001      | 75 < L < 140         | RAL 9010                               |    |
| 02V029001      | 141 < L < 160        | RAL 9010                               |    |

## attenzione

Il prezzo della H speciale va trovato nella tabella Misure speciali L / H in base alla L della parete doccia

Special price for H is to be found in Special sizes L / H as per L needed size

## warning

Misure speciali  
Special size

H max 160 cm  
L min 75 cm  
L max 160 cm

Disponibilità  
Availability

STOCK RAL9010

## supplementi

Sigillante SPARTAN®  
Sealant SPARTAN®

## supplements

€

36B010010

05 acrilico satin flack 11 reflex 12 reflex 16 satinato 24 nigol 25 flute 26 wave 27 aion 28 fumè brown 29 fumè 30 trasparente 31 extrachiaro 32 cincillà 34 stampato C

## origin

20 RAL9010

Approfondimenti  
Insights

|   |     |
|---|-----|
| Indice<br>Index                           | 3   |
| Legenda simboli<br>Icons legend           | 11  |
| Profili - Vetri<br>Profiles - Glasses     | 21  |
| Ricambi<br>Spare parts                    | 406 |
| Profili speciali<br>Special profiles      | 434 |
| Schede rilievo misure<br>Measurement form | 444 |

# Pieghevole

Parete doccia sopra vasca fissa di profondità per CO-SVF  
Fixed bathtub panel for CO-SVF

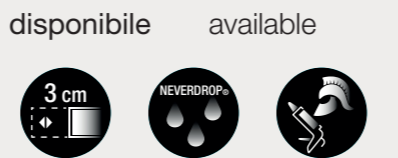
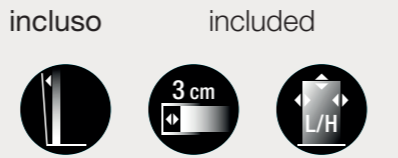
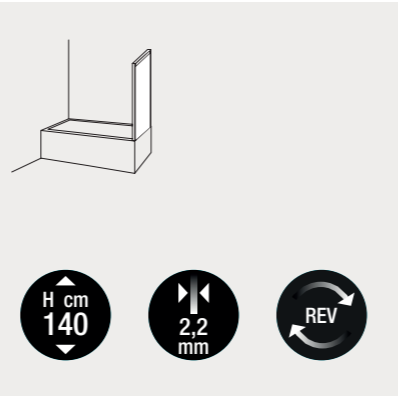

**installazioni**

su vasca for bathtub  
CO-SVF+CO-SVFF

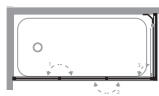

**informazioni**



Y lunghezza parete doccia\ shower wall length

**installations**

**informations**

|       |  |  |  |  |  |  |  |  |  |  |   |   |
|-------|--|--|--|--|--|--|--|--|--|--|---|---|
| Y     |  |  |  |  |  |  |  |  |  |  |   |   |
| 65-68 |  |  |  |  |  |  |  |  |  |  | 1 | 7 |

# CO-SVFF

INSTALLAZIONE SU VASCA DA BAGNO O MURETTO  
INSTALLATION ON BATHTUB OR LOW WALL

**Misure standard** Standard sizes

| Codice Code | estensibilità extension | Finiture profili Profiles finishing | 05 |
|-------------|-------------------------|-------------------------------------|----|
| 02F040065   | 65-68                   | RAL 9010                            |    |

**Misure speciali L / H** Special sizes L / H

| Codice Code | su misura bespoke | Finiture profili Profiles finishing | 05 |
|-------------|-------------------|-------------------------------------|----|
| 02F049001   | 35 < L < 60       | RAL 9010                            |    |
| 02F049001   | 61 < L < 80       | RAL 9010                            |    |
| 02F049001   | 81 < L < 90       | RAL 9010                            |    |

**attenzione**

Il prezzo della H speciale va trovato nella tabella Misure speciali L / H in base alla L della parete doccia

Special price for H is to be found in Special sizes L / H as per L needed size

**warning**

Coppia di sostegni obbligatori

Mandatory of couple of supports

**Misure speciali**  
Special size

|       |        |
|-------|--------|
| H max | 160 cm |
| L min | 35 cm  |
| L max | 90 cm  |

**supplementi**

Coppia di sostegni Couple of supports

€ 36S110001

Profilo di compensazione 3 cm Extension profile 3 cm

€ 35A010150

**supplements**

Sigillante SPARTAN® Sealant SPARTAN®

€ 36B010010

**Approfondimenti**  
Insights



|  |     |
|--|-----|
| Indice Index                           | 3   |
| Legenda simboli Icons legend           | 11  |
| Profili - Vetri Profiles - Glasses     | 21  |
| Ricambi Spare parts                    | 406 |
| Profili speciali Special profiles      | 434 |
| Schede rilievo misure Measurement form | 444 |

|                |       |        |          |       |       |      |      |            |      |             |             |          |            |
|----------------|-------|--------|----------|-------|-------|------|------|------------|------|-------------|-------------|----------|------------|
| 05             | 11    | 12     | 16       | 24    | 25    | 26   | 27   | 28         | 29   | 30          | 31          | 32       | 34         |
| acrilico satin | flack | reflex | satinato | nigol | flute | wave | alou | fumè brown | fumè | trasparente | extrachiara | cincillà | stampato C |

**origin**

20 RAL9010





**INDICE**  
INDEX PAG 3



**RICAMBI**  
SPARE PARTS PAG 406

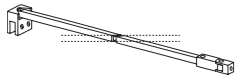
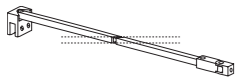
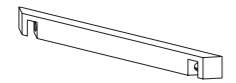
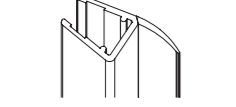
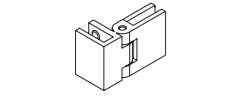
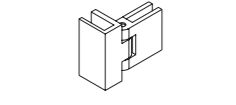

**PROFILI SPECIALI**  
SPECIAL PROFILES PAG 434

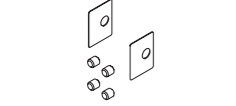

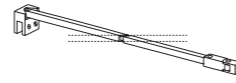
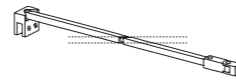
**SCHEDE RILIEVO MISURE**  
MEASUREMENTS FORMS PAG 444

**INFORMAZIONI E SERVIZI**  
INFO AND SERVICES PAG 450

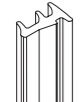
|   |   |                          |                                   |   |
|---|---|--------------------------|-----------------------------------|---|
|    | Supporto standard vetro-muro L 100 (con deviatore)<br>L 100 cm return to wall bar + T connection part | Cod.<br><b>36S117002</b> | Nr pezzi<br>Nr pieces<br><b>1</b> | € |
|    | Supporto standard vetro-muro L 150 (con deviatore)<br>L 150 cm return to wall bar + T connection part | Cod.<br><b>36S116002</b> | Nr pezzi<br>Nr pieces<br><b>1</b> | € |
|    | Supporto standard vetro-vetro fisso a 90°<br>Glass-to-glass standard support 90°                      | Cod.<br><b>36S121001</b> | Nr pezzi<br>Nr pieces<br><b>1</b> | € |
|    | Guarnizione verticale pinna parallela L 202<br>Vertical parallel fin seal L 202                       | Cod.<br><b>37R019127</b> | Nr pezzi<br>Nr pieces<br><b>1</b> | € |
|    | Cerniera superiore per B-6<br>Upper hinge for B-6   | Cod.<br><b>37R019218</b> | Nr pezzi<br>Nr pieces<br><b>1</b> | € |
|    | Cerniera inferiore per B-6<br>Lower hinge for B-6   | Cod.<br><b>37R019219</b> | Nr pezzi<br>Nr pieces<br><b>1</b> | € |
|   | Guarnizione fermavetro per IT-6 / IT-10 / IT-225 L 200<br>Rubber seal for IT-6 / IT-10 / IT-225 L 200 | Cod.<br><b>37R019221</b> | Nr pezzi<br>Nr pieces<br><b>1</b> | € |
|  | Guarnizione fermavetro per IT-8 L 200<br>Rubber seal for IT-8 L 200                                   | Cod.<br><b>37R019222</b> | Nr pezzi<br>Nr pieces<br><b>1</b> | € |
|  | Guarnizione fermavetro per L-6 L 200<br>Rubber seal for L-6 L 200                                     | Cod.<br><b>37R019297</b> | Nr pezzi<br>Nr pieces<br><b>1</b> | € |
|  | Grani e guarnizione per cerniere B-6<br>Grub screws and seals for hinges B-6                          | Cod.<br><b>37R019318</b> | Nr pezzi<br>Nr pieces<br><b>1</b> | € |

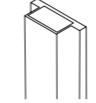
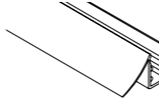
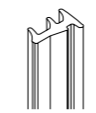
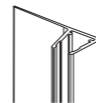

|   |   |                          |                                   |   |
|---|---|--------------------------|-----------------------------------|---|
|  | Supporto standard vetro-muro L 100 (con deviatore)<br>L 100 cm return to wall bar + T connection part | Cod.<br><b>36S117002</b> | Nr pezzi<br>Nr pieces<br><b>1</b> | € |
|  | Supporto standard vetro-muro L 150 (con deviatore)<br>L 150 cm return to wall bar + T connection part | Cod.<br><b>36S116002</b> | Nr pezzi<br>Nr pieces<br><b>1</b> | € |
|  | Guarnizione fermavetro per VI-6 L 200<br>Rubber seal for VI-6 L 200                                   | Cod.<br><b>37R019221</b> | Nr pezzi<br>Nr pieces<br><b>1</b> | € |
|  | Guarnizione fermavetro per VI-8 L 200<br>Rubber seal for VI-8 L 200                                   | Cod.<br><b>37R019222</b> | Nr pezzi<br>Nr pieces<br><b>1</b> | € |

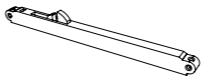
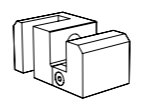
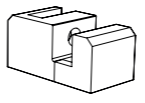
|   |   |                          |                                   |   |
|---|---|--------------------------|-----------------------------------|---|
|  | Supporto standard vetro-vetro fisso a 90°<br>Glass-to-glass standard support 90°                    | Cod.<br><b>36S121001</b> | Nr pezzi<br>Nr pieces<br><b>1</b> | € |
|  | Guarnizione fermavetro per RO-6 L 200<br>Rubber seal for RO-6 L 200                                 | Cod.<br><b>37R019221</b> | Nr pezzi<br>Nr pieces<br><b>1</b> | € |
|  | Guarnizione fermavetro per RO-6, RO-C6 e RO-L6 L 200<br>Rubber seal for RO-6, RO-C6 and RO-L6 L 200 | Cod.<br><b>37R019297</b> | Nr pezzi<br>Nr pieces<br><b>1</b> | € |
|  | Fissaggio soffitto<br>Ceiling fixing kit  | Cod.<br><b>37R019298</b> | Nr pezzi<br>Nr pieces<br><b>1</b> | € |

|   |  |                          |                                   |   |
|---|--|--------------------------|-----------------------------------|---|
|    | Magnete ricoperto L 210<br>Coated magnet L 210   | Cod.<br><b>37R019015</b> | Nr pezzi<br>Nr pieces<br><b>1</b> | € |
|    | Guarnizione inferiore porta L 75<br>Lower seal for door L 75   | Cod.<br><b>37R019186</b> | Nr pezzi<br>Nr pieces<br><b>1</b> | € |
|    | Guarnizione fermavetro L 200<br>Rubber seal L 200  | Cod.<br><b>37R019222</b> | Nr pezzi<br>Nr pieces<br><b>1</b> | € |
|    | Guarnizione verticale pinna perpendicolare 1 cm L 200<br>Vertical sealing gasket/perpendicular wing 1 cm L 200 | Cod.<br><b>37R019371</b> | Nr pezzi<br>Nr pieces<br><b>1</b> | € |
|    | Maniglia doppia esterna/interna<br>Double internal/external handle   | Cod.<br><b>37R019385</b> | Nr pezzi<br>Nr pieces<br><b>1</b> | € |
|    | Ammortizzatore<br>Shock absorber   | Cod.<br><b>37R019386</b> | Nr pezzi<br>Nr pieces<br><b>1</b> | € |
|   | Guida inferiore con sgancio DX<br>Lower rail with release RH   | Cod.<br><b>37R019387</b> | Nr pezzi<br>Nr pieces<br><b>1</b> | € |
|  | Guida inferiore con sgancio SX<br>Lower rail with release LH   | Cod.<br><b>37R019388</b> | Nr pezzi<br>Nr pieces<br><b>1</b> | € |

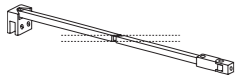
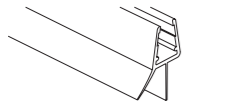
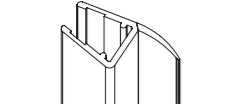
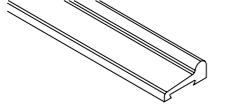
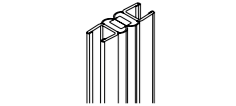
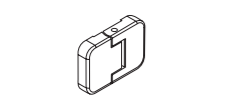
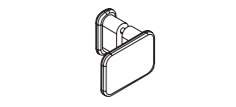

# Frigo

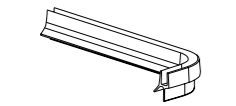
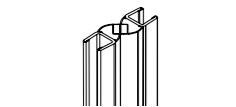
Ricambi  
Spare parts

|   |   |                          |                                   |   |
|---|---|--------------------------|-----------------------------------|---|
|    | Supporto standard vetro-muro L 100 (con deviatore)<br>L 100 cm return to wall bar + T connection part | Cod.<br><b>36S117002</b> | Nr pezzi<br>Nr pieces<br><b>1</b> | € |
|    | Guarnizione doppia aletta L 100<br>Double fin seal L 100  | Cod.<br><b>37R019022</b> | Nr pezzi<br>Nr pieces<br><b>1</b> | € |
|    | Guarnizione verticale pinna parallela L 202<br>Vertical parallel fin seal L 202                       | Cod.<br><b>37R019127</b> | Nr pezzi<br>Nr pieces<br><b>1</b> | € |
|    | Profilo barriera acqua 90° L 120<br>90° Anti-leakage profile L 120                                    | Cod.<br><b>37R019220</b> | Nr pezzi<br>Nr pieces<br><b>1</b> | € |
|    | Coppia di magneti bipolari 90° L 200<br>2 x Bipolar magnet 90° L 200                                  | Cod.<br><b>37R019327</b> | Nr pezzi<br>Nr pieces<br><b>1</b> | € |
|    | Cerniere<br>Hinges  | Cod.<br><b>37R019334</b> | Nr pezzi<br>Nr pieces<br><b>2</b> | € |
|   | Maniglia<br>Handle  | Cod.<br><b>37R019335</b> | Nr pezzi<br>Nr pieces<br><b>1</b> | € |
|  | Raccordi<br>Connection parts  | Cod.<br><b>37R019336</b> | Nr pezzi<br>Nr pieces<br><b>1</b> | € |
|  | Guarnizione per porta<br>Seal for door  | Cod.<br><b>37R019337</b> | Nr pezzi<br>Nr pieces<br><b>1</b> | € |
|  | Coppia di magneti bipolari 45° L 200<br>2 x Bipolar magnet 45° L 200                                  | Cod.<br><b>37R019338</b> | Nr pezzi<br>Nr pieces<br><b>1</b> | € |



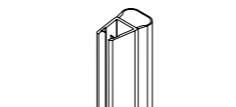
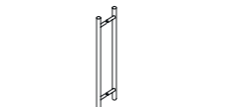
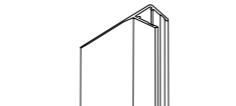
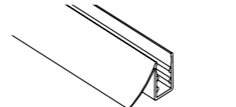

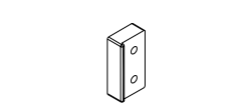
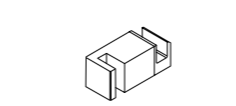

# Scroll/Rail

Ricambi  
Spare parts

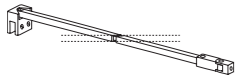
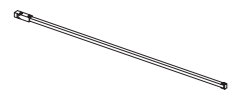
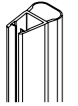
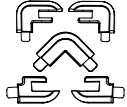
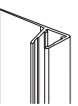
|   |  |                          |                                   |   |
|---|--|--------------------------|-----------------------------------|---|
|    | Profilo barriera acqua L 70<br>Anti-leakage profile L 70                   | Cod.<br><b>37P646001</b> | Nr pezzi<br>Nr pieces<br><b>1</b> | € |
|    | Guarnizione verticale palloncino L 210<br>Vertical tubular seal L 210      | Cod.<br><b>37R019115</b> | Nr pezzi<br>Nr pieces<br><b>1</b> | € |
|    | Maniglia<br>Handle   | Cod.<br><b>37R019117</b> | Nr pezzi<br>Nr pieces<br><b>1</b> | € |
|    | Guarnizione verticale pinna 30 mm L 200<br>Vertical fin seal 30 mm L 200   | Cod.<br><b>37R019124</b> | Nr pezzi<br>Nr pieces<br><b>1</b> | € |
|    | Guarnizione inferiore porta L 75<br>Lower seal for door L 75               | Cod.<br><b>37R019186</b> | Nr pezzi<br>Nr pieces<br><b>1</b> | € |
|    | Ghiere fissaggio per profilo muro<br>Locking rings for wall profile fixing | Cod.<br><b>37R019188</b> | Nr pezzi<br>Nr pieces<br><b>2</b> | € |
|   | Ghiere fissaggio barra/vetro<br>Locking rings for bar/glass fixing         | Cod.<br><b>37R019189</b> | Nr pezzi<br>Nr pieces<br><b>2</b> | € |
|  | Gruppo scorrimento<br>Sliding kit  | Cod.<br><b>37R019190</b> | Nr pezzi<br>Nr pieces<br><b>2</b> | € |
|  | Distanziale per IS-PSC<br>Spacer for IS-PSC                                | Cod.<br><b>37R019191</b> | Nr pezzi<br>Nr pieces<br><b>1</b> | € |
|  | Guida inferiore con sgancio<br>Lower rail with release                     | Cod.<br><b>37R019192</b> | Nr pezzi<br>Nr pieces<br><b>1</b> | € |

# Pluma Evo

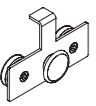
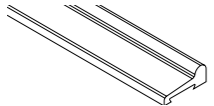
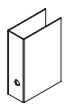
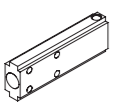

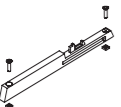
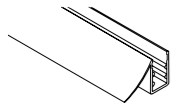



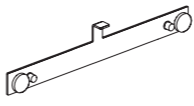
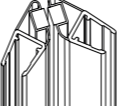
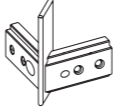
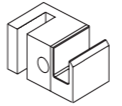
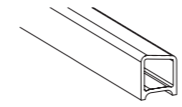
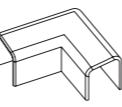
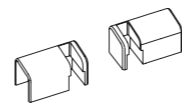

Ricambi  
Spare parts

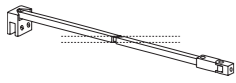
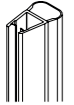
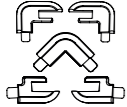
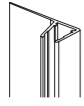

|   |   |                          |                                   |   |
|---|---|--------------------------|-----------------------------------|---|
|    | Supporto standard vetro-muro L 100 (con deviatore)<br>L 100 cm return to wall bar + T connection part | Cod.<br><b>36S117002</b> | Nr pezzi<br>Nr pieces<br><b>1</b> | € |
|    | Tirante di rinforzo regolabile<br>Adjustable reinforcement tie-rod                                    | Cod.<br><b>36S140001</b> | Nr pezzi<br>Nr pieces<br><b>1</b> | € |
|    | Guarnizione verticale palloncino L 210<br>Vertical tubular seal L 210                                 | Cod.<br><b>37R019115</b> | Nr pezzi<br>Nr pieces<br><b>1</b> | € |
|    | Raccordi per vetro spessore 8 mm<br>Connection parts for glass 8 mm                                   | Cod.<br><b>37R019383</b> | Nr pezzi<br>Nr pieces<br><b>1</b> | € |
|    | Guarnizione verticale pinna perpendicolare 16 mm L 205<br>Vertical fin seal 16 mm L 205               | Cod.<br><b>37R019147</b> | Nr pezzi<br>Nr pieces<br><b>1</b> | € |
|    | Maniglia doppia esterna/interna<br>Double internal/external handle                                    | Cod.<br><b>37R019380</b> | Nr pezzi<br>Nr pieces<br><b>1</b> | € |
|   | Maniglia esterna + pomolo interno<br>External handle + internal knob                                  | Cod.<br><b>37R019381</b> | Nr pezzi<br>Nr pieces<br><b>1</b> | € |
|  | Ghiere binario<br>Rail locking rings  | Cod.<br><b>37R019158</b> | Nr pezzi<br>Nr pieces<br><b>2</b> | € |
|  | Gruppo scorrimento ruote per PL-PSC<br>Wheels sliding set for PL-PSC                                  | Cod.<br><b>37R019160</b> | Nr pezzi<br>Nr pieces<br><b>1</b> | € |
|  | Profilo barriera acqua 90° L 120<br>90° Anti-leakage profile L 120                                    | Cod.<br><b>37R019220</b> | Nr pezzi<br>Nr pieces<br><b>1</b> | € |
|  | Carter binario<br>Cover for rail  | Cod.<br><b>37R019162</b> | Nr pezzi<br>Nr pieces<br><b>1</b> | € |
|  | Slitta ancoraggio<br>Locking system for Slide   | Cod.<br><b>37R019164</b> | Nr pezzi<br>Nr pieces<br><b>1</b> | € |
|  | Piastrina fissaggio binario<br>Fixing kit for rail  | Cod.<br><b>37R019171</b> | Nr pezzi<br>Nr pieces<br><b>1</b> | € |
|  | Ammortizzatore<br>Shock absorber  | Cod.<br><b>37R019176</b> | Nr pezzi<br>Nr pieces<br><b>1</b> | € |
|  | Guarnizione inferiore porta per PL-PSC L 79<br>Lower seal for door PL-PSC L 79                        | Cod.<br><b>37R019186</b> | Nr pezzi<br>Nr pieces<br><b>1</b> | € |

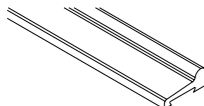
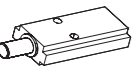
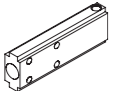

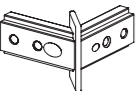
# Pluma Evo

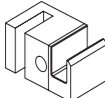
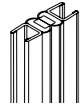

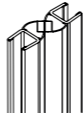
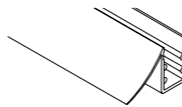
Ricambi  
Spare parts

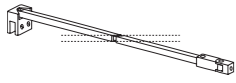
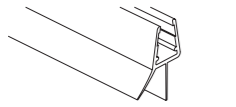
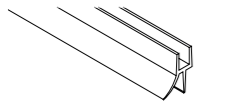

|   |   |                          |                                   |   |
|---|---|--------------------------|-----------------------------------|---|
|    | Ghiere binario regolabile<br>Adjustable rail locking rings                              | Cod.<br><b>37R019187</b> | Nr pezzi<br>Nr pieces<br><b>2</b> | € |
|    | Gruppo scorrimento P224 per PL-PSC2 e PL-ASC<br>Sliding kit P224 for PL-PSC2 and PL-ASC | Cod.<br><b>37R019226</b> | Nr pezzi<br>Nr pieces<br><b>1</b> | € |
|    | Magnete chiusura per PL-ASC L 200<br>Closing magnet for PL-ASC L 200                    | Cod.<br><b>37R019230</b> | Nr pezzi<br>Nr pieces<br><b>2</b> | € |
|    | Raccordo angolare<br>Corner connection  | Cod.<br><b>37R019231</b> | Nr pezzi<br>Nr pieces<br><b>1</b> | € |
|    | Guida inferiore con sgancio<br>Lower rail with release                                  | Cod.<br><b>37R019299</b> | Nr pezzi<br>Nr pieces<br><b>1</b> | € |
|    | Profilo tenuta maggiorato L 79<br>Oversize anti-leakage profile L 79                    | Cod.<br><b>37R019300</b> | Nr pezzi<br>Nr pieces<br><b>1</b> | € |
|   | Raccordo angolare<br>Corner connection  | Cod.<br><b>37R019301</b> | Nr pezzi<br>Nr pieces<br><b>1</b> | € |
|  | Raccordi in linea<br>In-line connections  | Cod.<br><b>37R019302</b> | Nr pezzi<br>Nr pieces<br><b>2</b> | € |

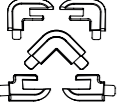
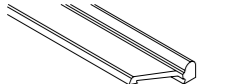
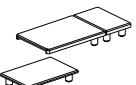
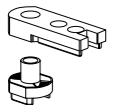
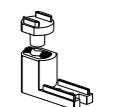
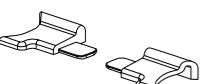
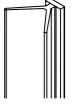
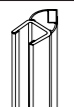
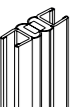
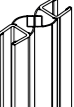

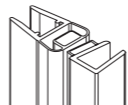
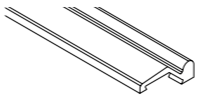
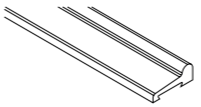
|   |   |                          |                                   |   |
|---|---|--------------------------|-----------------------------------|---|
|    | Supporto standard vetro-muro L 100 (con deviatore)<br>L 100 cm return to wall bar + T connection part | Cod.<br><b>36S117002</b> | Nr pezzi<br>Nr pieces<br><b>1</b> | € |
|    | Guarnizione verticale palloncino L 210<br>Vertical tubular seal L 210                                 | Cod.<br><b>37R019115</b> | Nr pezzi<br>Nr pieces<br><b>1</b> | € |
|    | Raccordi per vetro spessore 6 mm<br>Connection parts for glass 6 mm                                   | Cod.<br><b>37R019134</b> | Nr pezzi<br>Nr pieces<br><b>1</b> | € |
|    | Guarnizione verticale pinna perpendicolare 16 mm L 205<br>Vertical fin seal 16 mm L 205               | Cod.<br><b>37R019147</b> | Nr pezzi<br>Nr pieces<br><b>1</b> | € |
|    | Maniglia doppia esterna/interna<br>Double internal/external handle                                    | Cod.<br><b>37R019380</b> | Nr pezzi<br>Nr pieces<br><b>1</b> | € |
|    | Maniglia esterna + pomolo interno<br>External handle + internal knob                                  | Cod.<br><b>37R019381</b> | Nr pezzi<br>Nr pieces<br><b>1</b> | € |
|   | Ghiere binario<br>Rail locking rings  | Cod.<br><b>37R019158</b> | Nr pezzi<br>Nr pieces<br><b>2</b> | € |
|  | Profilo barriera acqua 90° L 120<br>90° Anti-leakage profile L 120                                    | Cod.<br><b>37R019220</b> | Nr pezzi<br>Nr pieces<br><b>1</b> | € |
|  | Slitta con paracolpo<br>Slide with shock absorber   | Cod.<br><b>37R019163</b> | Nr pezzi<br>Nr pieces<br><b>1</b> | € |
|  | Slitta ancoraggio<br>Locking system for Slide   | Cod.<br><b>37R019164</b> | Nr pezzi<br>Nr pieces<br><b>1</b> | € |
|  | Gruppo scorrimento<br>Sliding kit   | Cod.<br><b>37R019170</b> | Nr pezzi<br>Nr pieces<br><b>1</b> | € |
|  | Raccordo angolare<br>Corner connection  | Cod.<br><b>37R019180</b> | Nr pezzi<br>Nr pieces<br><b>1</b> | € |
|  | Ghiere binario regolabile<br>Adjustable rail locking rings  | Cod.<br><b>37R019187</b> | Nr pezzi<br>Nr pieces<br><b>2</b> | € |
|  | Guida inferiore con sgancio<br>Lower rail with release  | Cod.<br><b>37R019299</b> | Nr pezzi<br>Nr pieces<br><b>1</b> | € |
|  | Coppia di magneti bipolari 90° L 200<br>2 x Bipolar magnet 90° L 200                                  | Cod.<br><b>37R019327</b> | Nr pezzi<br>Nr pieces<br><b>1</b> | € |

|   |  |                          |                                   |   |
|---|--|--------------------------|-----------------------------------|---|
|  | Coppia di magneti bipolari 45° L 200<br>2 x Bipolar magnet 45° L 200 | Cod.<br><b>37R019338</b> | Nr pezzi<br>Nr pieces<br><b>1</b> | € |
|  | Guarnizione inferiore L 79<br>Lower Seal L 79                        | Cod.<br><b>37R019349</b> | Nr pezzi<br>Nr pieces<br><b>1</b> | € |
|  | Carter binario<br>Cover for rail                                     | Cod.<br><b>37R019350</b> | Nr pezzi<br>Nr pieces<br><b>1</b> | € |
|  | Piastrina fissaggio binario<br>Fixing kit rail                       | Cod.<br><b>37R019359</b> | Nr pezzi<br>Nr pieces<br><b>1</b> | € |

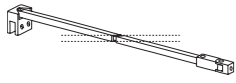
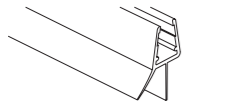
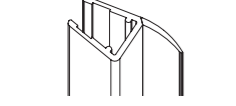
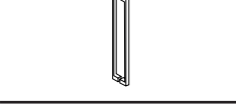
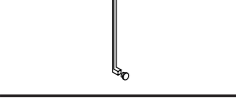
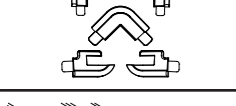
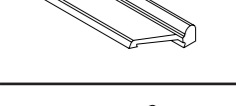
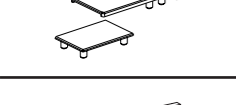
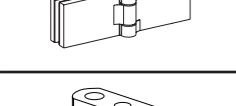
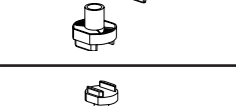
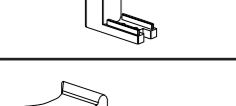
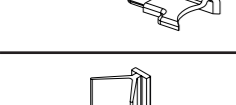
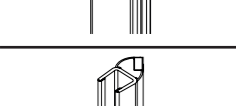
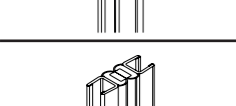

|   |   |                          |                                   |   |
|---|---|--------------------------|-----------------------------------|---|
|    | Supporto standard vetro-muro L 100 (con deviatore)<br>L 100 cm return to wall bar + T connection part | Cod.<br><b>36S117002</b> | Nr pezzi<br>Nr pieces<br><b>1</b> | € |
|    | Guarnizione doppia aletta L 100<br>Double fin seal L 100  | Cod.<br><b>37R019022</b> | Nr pezzi<br>Nr pieces<br><b>1</b> | € |
|    | Guarnizione pinna doppia per MO-TBA2 L 100<br>Double fin seal for MO-TBA2 L 100                       | Cod.<br><b>37R019113</b> | Nr pezzi<br>Nr pieces<br><b>1</b> | € |
|    | Maniglia doppia esterna/interna<br>Double internal/external handle                                    | Cod.<br><b>37R019380</b> | Nr pezzi<br>Nr pieces<br><b>1</b> | € |
|    | Maniglia esterna + pomolo interno<br>External handle + internal knob                                  | Cod.<br><b>37R019381</b> | Nr pezzi<br>Nr pieces<br><b>1</b> | € |
|    | Raccordi per vetro spessore 6 mm<br>Connection parts for glass 6 mm                                   | Cod.<br><b>37R019134</b> | Nr pezzi<br>Nr pieces<br><b>1</b> | € |
|   | Profilo barriera 45° H 200<br>Anti-leakage profile 45° H 200  | Cod.<br><b>37R019376</b> | Nr pezzi<br>Nr pieces<br><b>1</b> | € |
|  | Tappi copertura<br>Screw caps   | Cod.<br><b>37R019243</b> | Nr pezzi<br>Nr pieces<br><b>2</b> | € |
|  | Perno superiore<br>Upper hinge Mork   | Cod.<br><b>37R019292</b> | Nr pezzi<br>Nr pieces<br><b>1</b> | € |
|  | Perno inferiore<br>Lower hinge Mork   | Cod.<br><b>37R019293</b> | Nr pezzi<br>Nr pieces<br><b>1</b> | € |
|  | Raccordo inferiore<br>Lower connection  | Cod.<br><b>37R019295</b> | Nr pezzi<br>Nr pieces<br><b>2</b> | € |
|  | Guarnizione verticale tenuta L 200<br>Vertical anti-leakage seal L 200                                | Cod.<br><b>37R019296</b> | Nr pezzi<br>Nr pieces<br><b>1</b> | € |
|  | Magne bipolare 45° L 200<br>Bipolar magnet 45° L 200  | Cod.<br><b>37R019326</b> | Nr pezzi<br>Nr pieces<br><b>1</b> | € |
|  | Coppia di magneti bipolari 90° L 200<br>2 x Bipolar magnet 90° L 200                                  | Cod.<br><b>37R019327</b> | Nr pezzi<br>Nr pieces<br><b>1</b> | € |
|  | Coppia di magneti bipolari 45° L 200<br>2 x Bipolar magnet 45° L 200                                  | Cod.<br><b>37R019338</b> | Nr pezzi<br>Nr pieces<br><b>1</b> | € |

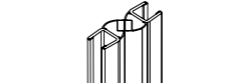
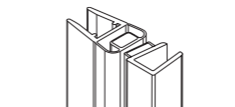
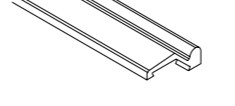

|   |  |                          |                                     |   |
|---|--|--------------------------|-------------------------------------|---|
|  | Coppia di magneti bipolari 90° per MO-PIO L 210<br>2 x Bipolar magnet 90° for MO-PIO L 210                 | Cod.<br><b>37R019377</b> | Nr pezzi<br>Nr pieces<br><b>1+1</b> | € |
|  | Profilo tenuta acqua 45° per In/Out L 200<br>45° Anti-leakage profile for In/Out L 200                     | Cod.<br><b>37R019405</b> | Nr pezzi<br>Nr pieces<br><b>1</b>   | € |
|  | Profilo barriera acqua curvo - Semicircolare MO-TBA2<br>Curved anti-leakage profile - Semicircular MO-TBA2 | Cod.<br><b>37R019140</b> | Nr pezzi<br>Nr pieces<br><b>1</b>   | € |
|  | Profilo barriera acqua 90° L 120<br>90° Anti-leakage profile L 120   | Cod.<br><b>37R019220</b> | Nr pezzi<br>Nr pieces<br><b>1</b>   | € |

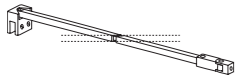
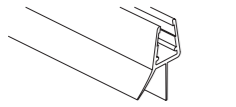
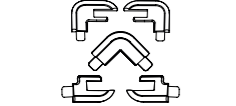
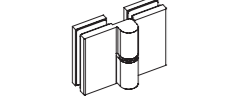
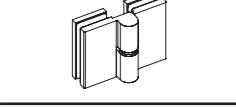
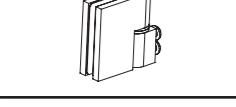
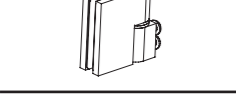
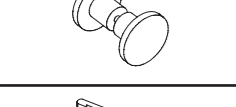
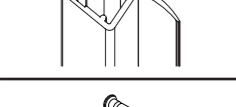
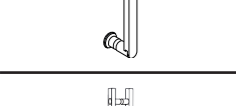
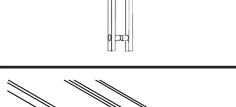
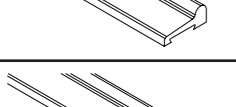
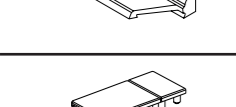
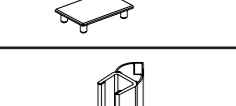
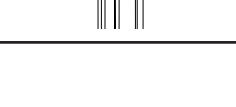

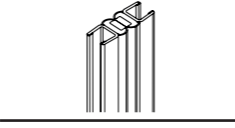



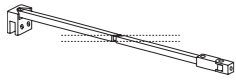
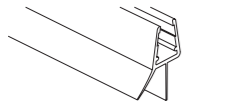
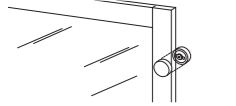
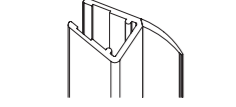
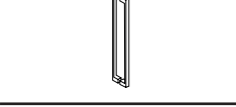
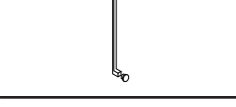
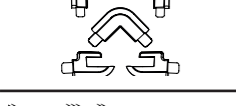
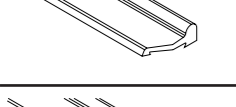
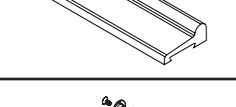
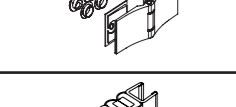

|   |   |                          |                                   |   |
|---|---|--------------------------|-----------------------------------|---|
|    | Supporto standard vetro-muro L 100 (con deviatore)<br>L 100 cm return to wall bar + T connection part | Cod.<br><b>36S117002</b> | Nr pezzi<br>Nr pieces<br><b>1</b> | € |
|    | Guarnizione doppia aletta L 100<br>Double fin seal L 100  | Cod.<br><b>37R019022</b> | Nr pezzi<br>Nr pieces<br><b>1</b> | € |
|    | Guarnizione verticale pinna parallela L 202<br>Vertical parallel fin seal L 202                       | Cod.<br><b>37R019127</b> | Nr pezzi<br>Nr pieces<br><b>1</b> | € |
|    | Maniglia doppia esterna/interna<br>Double internal/external handle                                    | Cod.<br><b>37R019380</b> | Nr pezzi<br>Nr pieces<br><b>1</b> | € |
|    | Maniglia esterna + pomolo interno<br>External handle + internal knob                                  | Cod.<br><b>37R019381</b> | Nr pezzi<br>Nr pieces<br><b>1</b> | € |
|    | Raccordi per vetro spessore 6 mm<br>Connection parts for glass 6 mm                                   | Cod.<br><b>37R019134</b> | Nr pezzi<br>Nr pieces<br><b>1</b> | € |
|   | Profilo barriera 45° H 200<br>Anti-leakage profile 45° H 200  | Cod.<br><b>37R019376</b> | Nr pezzi<br>Nr pieces<br><b>1</b> | € |
|  | Tappi copertura<br>Screw caps   | Cod.<br><b>37R019243</b> | Nr pezzi<br>Nr pieces<br><b>2</b> | € |
|  | Cerniera<br>Hinge   | Cod.<br><b>37R019263</b> | Nr pezzi<br>Nr pieces<br><b>1</b> | € |
|  | Perno superiore<br>Upper hinge Mork   | Cod.<br><b>37R019292</b> | Nr pezzi<br>Nr pieces<br><b>1</b> | € |
|  | Perno inferiore<br>Lower hinge  | Cod.<br><b>37R019293</b> | Nr pezzi<br>Nr pieces<br><b>1</b> | € |
|  | Raccordo inferiore<br>Lower connection  | Cod.<br><b>37R019295</b> | Nr pezzi<br>Nr pieces<br><b>2</b> | € |
|  | Guarnizione verticale tenuta L 200<br>Vertical anti-leakage seal L 200                                | Cod.<br><b>37R019296</b> | Nr pezzi<br>Nr pieces<br><b>1</b> | € |
|  | Magnete bipolare 45° L 200<br>Bipolar magnet 45° L 200  | Cod.<br><b>37R019326</b> | Nr pezzi<br>Nr pieces<br><b>1</b> | € |
|  | Coppia di magneti bipolari 90° L 200<br>2 x Bipolar magnet 90° L 200                                  | Cod.<br><b>37R019327</b> | Nr pezzi<br>Nr pieces<br><b>1</b> | € |

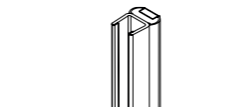
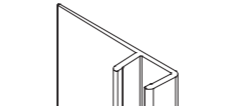
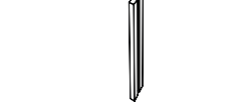
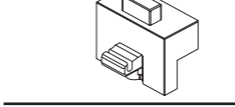

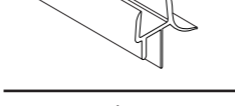
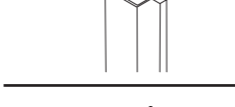
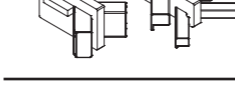

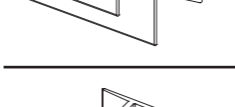
|   |  |                          |                                     |   |
|---|--|--------------------------|-------------------------------------|---|
|  | Coppia di magneti bipolari 45° L 200<br>2 x Bipolar magnet 45° L 200                       | Cod.<br><b>37R019338</b> | Nr pezzi<br>Nr pieces<br><b>1</b>   | € |
|  | Coppia di magneti bipolari 90° per MI-PIO L 210<br>2 x Bipolar magnet 90° for MI-PIO L 210 | Cod.<br><b>37R019377</b> | Nr pezzi<br>Nr pieces<br><b>1+1</b> | € |
|  | Profilo tenuta acqua 45° per In/Out L 200<br>45° Anti-leakage profile for In/Out L 200     | Cod.<br><b>37R019405</b> | Nr pezzi<br>Nr pieces<br><b>1</b>   | € |
|  | Profilo barriera acqua 90° L 120<br>90° Anti-leakage profile L 120                         | Cod.<br><b>37R019220</b> | Nr pezzi<br>Nr pieces<br><b>1</b>   | € |

|   |   |                          |                                   |   |
|---|---|--------------------------|-----------------------------------|---|
|    | Supporto standard vetro-muro L 100 (con deviatore)<br>L 100 cm return to wall bar + T connection part | Cod.<br><b>36S117002</b> | Nr pezzi<br>Nr pieces<br><b>1</b> | € |
|    | Guarnizione doppia aletta L 100<br>Double fin seal L 100  | Cod.<br><b>37R019022</b> | Nr pezzi<br>Nr pieces<br><b>1</b> | € |
|    | Raccordi per vetro spessore 6 mm<br>Connection parts for glass 6 mm                                   | Cod.<br><b>37R019134</b> | Nr pezzi<br>Nr pieces<br><b>1</b> | € |
|    | Cerniera centrale DX<br>Central hinge RH  | Cod.<br><b>37R019202</b> | Nr pezzi<br>Nr pieces<br><b>1</b> | € |
|    | Cerniera centrale SX<br>Central hinge LH  | Cod.<br><b>37R019203</b> | Nr pezzi<br>Nr pieces<br><b>1</b> | € |
|    | Cerniera lato muro DX<br>Wall hinge RH  | Cod.<br><b>37R019204</b> | Nr pezzi<br>Nr pieces<br><b>1</b> | € |
|   | Cerniera lato muro SX<br>Wall hinge LH  | Cod.<br><b>37R019205</b> | Nr pezzi<br>Nr pieces<br><b>1</b> | € |
|  | Pomoli<br>Handle set  | Cod.<br><b>37R019207</b> | Nr pezzi<br>Nr pieces<br><b>2</b> | € |
|  | Guarnizione verticale pinna parallela L 202<br>Vertical parallel fin seal L 202                       | Cod.<br><b>37R019127</b> | Nr pezzi<br>Nr pieces<br><b>1</b> | € |
|  | Maniglia sganciabile<br>Unlocking Handle  | Cod.<br><b>37R019209</b> | Nr pezzi<br>Nr pieces<br><b>1</b> | € |
|  | Maniglia<br>Handle  | Cod.<br><b>37R019210</b> | Nr pezzi<br>Nr pieces<br><b>1</b> | € |
|  | Profilo barriera acqua PMR L 120<br>Anti-leakage profile PMR L 120                                    | Cod.<br><b>37R019220</b> | Nr pezzi<br>Nr pieces<br><b>1</b> | € |
|  | Profilo barriera taglio 45° L 200<br>45° Anti-leakage profile L 200                                   | Cod.<br><b>37R019376</b> | Nr pezzi<br>Nr pieces<br><b>1</b> | € |
|  | Tappi copertura<br>Screw caps   | Cod.<br><b>37R019243</b> | Nr pezzi<br>Nr pieces<br><b>2</b> | € |
|  | Magnete bipolare 45° L 200<br>Bipolar magnet 45° L 200  | Cod.<br><b>37R019326</b> | Nr pezzi<br>Nr pieces<br><b>1</b> | € |

|   |  |                          |                                   |   |
|---|--|--------------------------|-----------------------------------|---|
|  | Coppia di magneti bipolari 90° L 200<br>2 x Bipolar magnet 90° L 200 | Cod.<br><b>37R019327</b> | Nr pezzi<br>Nr pieces<br><b>1</b> | € |
|  | Coppia di magneti bipolari 45° L 200<br>2 x Bipolar magnet 45° L 200 | Cod.<br><b>37R019338</b> | Nr pezzi<br>Nr pieces<br><b>1</b> | € |

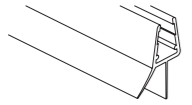
|   |   |                          |                                   |   |
|---|---|--------------------------|-----------------------------------|---|
|    | Supporto standard vetro-muro L 23 cm<br>L 23 cm return to wall bar standard     | Cod.<br><b>36S117003</b> | Nr pezzi<br>Nr pieces<br><b>1</b> | € |
|    | Guarnizione doppia aletta L 100<br>Double fin seal L 100                        | Cod.<br><b>37R019022</b> | Nr pezzi<br>Nr pieces<br><b>1</b> | € |
|    | Viteria fissaggio profili<br>Screws for profiles fixing                         | Cod.<br><b>37R019112</b> | Nr pezzi<br>Nr pieces<br><b>1</b> | € |
|    | Guarnizione verticale pinna parallela L 202<br>Vertical parallel fin seal L 202 | Cod.<br><b>37R019127</b> | Nr pezzi<br>Nr pieces<br><b>1</b> | € |
|    | Maniglia doppia esterna/interna<br>Double internal/external handle              | Cod.<br><b>37R019380</b> | Nr pezzi<br>Nr pieces<br><b>1</b> | € |
|    | Maniglia esterna + pomolo interno<br>External handle + internal knob            | Cod.<br><b>37R019381</b> | Nr pezzi<br>Nr pieces<br><b>1</b> | € |
|   | Raccordi per vetro spessore 6 mm<br>Connection parts for glass 6 mm             | Cod.<br><b>37R019134</b> | Nr pezzi<br>Nr pieces<br><b>1</b> | € |
|  | Profilo barriera acqua per FO-PBA L 67<br>Anti-leakage profile for FO-PBA L 67  | Cod.<br><b>37R019136</b> | Nr pezzi<br>Nr pieces<br><b>1</b> | € |
|  | Profilo barriera acqua 90° L 120<br>90° Anti-leakage profile L 120              | Cod.<br><b>37R019220</b> | Nr pezzi<br>Nr pieces<br><b>1</b> | € |
|  | Cerniera regolabile<br>Adjustable hinge   | Cod.<br><b>37R019406</b> | Nr pezzi<br>Nr pieces<br><b>1</b> | € |
|  | Coppia di magneti bipolari 90° L 200<br>2 x Bipolar magnet 90° L 200            | Cod.<br><b>37R019327</b> | Nr pezzi<br>Nr pieces<br><b>1</b> | € |
|  | Coppia di magneti bipolari 45° L 200<br>2 x Bipolar magnet 45° L 200            | Cod.<br><b>37R019338</b> | Nr pezzi<br>Nr pieces<br><b>1</b> | € |

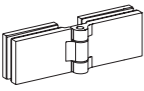
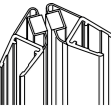
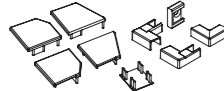
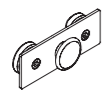
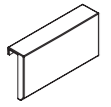
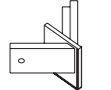
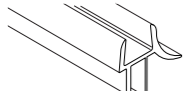
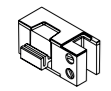
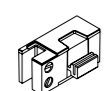
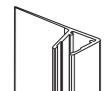

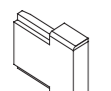
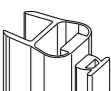

|   |  |                          |                                   |   |
|---|--|--------------------------|-----------------------------------|---|
|    | Coppia di magneti bipolari 45° L 200<br>2 x Bipolar magnet 45° L 200   | Cod.<br><b>37R019407</b> | Nr pezzi<br>Nr pieces<br><b>1</b> | € |
|    | Magnete bipolare 90° L 200<br>Bipolar magnet 90° L 200   | Cod.<br><b>37R019408</b> | Nr pezzi<br>Nr pieces<br><b>1</b> | € |
|    | Guarnizione verticale pinna perpendicolare 16 mm L 200<br>Vertical sealing gasket/perpendicular wing 16 mm L 200 | Cod.<br><b>37R019409</b> | Nr pezzi<br>Nr pieces<br><b>1</b> | € |
|    | Maniglia doppia esterna/interna<br>Double internal/external handle   | Cod.<br><b>37R019410</b> | Nr pezzi<br>Nr pieces<br><b>1</b> | € |
|    | Guida inferiore con sgancio<br>Lower rail with release   | Cod.<br><b>37R019411</b> | Nr pezzi<br>Nr pieces<br><b>1</b> | € |
|    | Guarnizione fermavetro L 210<br>Rubber seal L 210  | Cod.<br><b>37R019412</b> | Nr pezzi<br>Nr pieces<br><b>1</b> | € |
|   | Guarnizione inferiore per porta scorrevole L 80<br>Lower gasket for sliding door L.80                            | Cod.<br><b>37R019413</b> | Nr pezzi<br>Nr pieces<br><b>1</b> | € |
|  | Magnete ricoperto L 210<br>Coated magnet L 210   | Cod.<br><b>37R019015</b> | Nr pezzi<br>Nr pieces<br><b>1</b> | € |
|  | Coppia di raccordi angolari<br>Pair of corner connections  | Cod.<br><b>37R019414</b> | Nr pezzi<br>Nr pieces<br><b>1</b> | € |
|  | Tappo copri eccentrico<br>Eccentric cover cap  | Cod.<br><b>37R019415</b> | Nr pezzi<br>Nr pieces<br><b>1</b> | € |
|  | Guarnizione inferiore per porta pivot L 90<br>Lower gasket for pivoting door L 90                                | Cod.<br><b>37R019416</b> | Nr pezzi<br>Nr pieces<br><b>1</b> | € |
|  | Guarnizione verticale pinna perpendicolare 5 mm L 200<br>Vertical sealing gasket/perpendicular wing 5 mm L 200   | Cod.<br><b>37R019417</b> | Nr pezzi<br>Nr pieces<br><b>1</b> | € |
|  | Guarnizione verticale palloncino L 200<br>Vertical tubular seal L 200  | Cod.<br><b>37R019418</b> | Nr pezzi<br>Nr pieces<br><b>1</b> | € |
|  | Guarnizione verticale pinna parallela L 202<br>Vertical parallel fin seal L 202                                  | Cod.<br><b>37R019127</b> | Nr pezzi<br>Nr pieces<br><b>1</b> | € |

|   |  |                          |                                   |   |
|---|--|--------------------------|-----------------------------------|---|
|    | Guarnizione doppia aletta L 100 - Apertura battente<br>Double fin seal L 100 - Hinged door                       | Cod.<br><b>37R019022</b> | Nr pezzi<br>Nr pieces<br><b>1</b> | € |
|    | Magnete bipolare 45° + magnete piatto L 200<br>Bipolar magnet 45° + flat magnet L 200                            | Cod.<br><b>37R019389</b> | Nr pezzi<br>Nr pieces<br><b>1</b> | € |
|    | Cerniera<br>Hinge  | Cod.<br><b>37R019263</b> | Nr pezzi<br>Nr pieces<br><b>1</b> | € |
|    | Magnete chiusura per OT-ASC L 200<br>Closing magnet for OT-ASC L 200   | Cod.<br><b>37R019230</b> | Nr pezzi<br>Nr pieces<br><b>2</b> | € |
|    | Tappi di copertura profili a parete<br>Wall profile cover caps   | Cod.<br><b>37R019363</b> | Nr pezzi<br>Nr pieces<br><b>1</b> | € |
|    | Carrelli in acciaio<br>Steel rollers   | Cod.<br><b>37R019364</b> | Nr pezzi<br>Nr pieces<br><b>2</b> | € |
|   | Tappi di copertura carrelli<br>Cover caps for rollers  | Cod.<br><b>37R019365</b> | Nr pezzi<br>Nr pieces<br><b>2</b> | € |
|  | Raccordo angolare<br>Corner connection   | Cod.<br><b>37R019366</b> | Nr pezzi<br>Nr pieces<br><b>1</b> | € |
|  | Guarnizione inferiore - Apertura scorrevole<br>Lower sealing gasket - Sliding door                               | Cod.<br><b>37R019368</b> | Nr pezzi<br>Nr pieces<br><b>1</b> | € |
|  | Pattino guida inferiore sgancio SX<br>Lower guiding slider release LH  | Cod.<br><b>37R019369</b> | Nr pezzi<br>Nr pieces<br><b>1</b> | € |
|  | Pattino guida inferiore sgancio DX<br>Lower guiding slider release RH  | Cod.<br><b>37R019370</b> | Nr pezzi<br>Nr pieces<br><b>1</b> | € |
|  | Guarnizione verticale pinna perpendicolare 10 mm L 200<br>Vertical sealing gasket/perpendicular wing 10 mm L 200 | Cod.<br><b>37R019371</b> | Nr pezzi<br>Nr pieces<br><b>1</b> | € |
|  | Guarnizione fermavetro L 100<br>Glass-blocking gasket L100   | Cod.<br><b>37R019372</b> | Nr pezzi<br>Nr pieces<br><b>1</b> | € |
|  | Finecorsa grigio<br>Grey endblocks   | Cod.<br><b>37R019373</b> | Nr pezzi<br>Nr pieces<br><b>2</b> | € |
|  | Magnete bipolare 90° + magnete piatto L 200<br>Bipolar magnet 90° + flat magnet L 200                            | Cod.<br><b>37R019374</b> | Nr pezzi<br>Nr pieces<br><b>1</b> | € |

|   |  |                          |                                   |   |
|---|--|--------------------------|-----------------------------------|---|
|  | Coppia di magneti bipolari 90° L 200<br>2 x Bipolar magnet 90° L 200                 | Cod.<br><b>37R019375</b> | Nr pezzi<br>Nr pieces<br><b>1</b> | € |
|  | Maniglia doppia esterna/interna<br>Double internal/external handle                   | Cod.<br><b>37R019380</b> | Nr pezzi<br>Nr pieces<br><b>1</b> | € |
|  | Maniglia esterna + pomolo interno<br>External handle + internal knob                 | Cod.<br><b>37R019381</b> | Nr pezzi<br>Nr pieces<br><b>1</b> | € |
|  | Guarnizione verticale a pinna parallela L 200<br>Vertical parallel fin sealing L 200 | Cod.<br><b>37R019382</b> | Nr pezzi<br>Nr pieces<br><b>1</b> | € |
|  | Raccordi per vetro spessore 8 mm<br>Connection parts for glass 8 mm                  | Cod.<br><b>37R019383</b> | Nr pezzi<br>Nr pieces<br><b>1</b> | € |

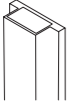
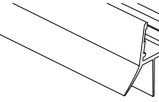
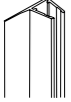
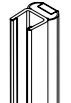
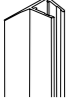

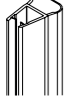
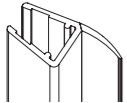
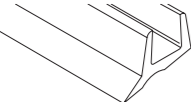

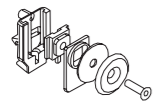
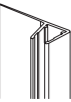
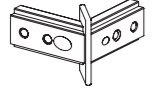
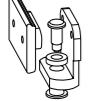
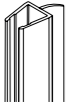



# Dado Maxi

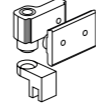
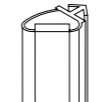
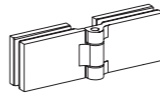

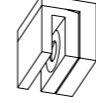
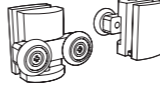
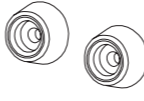
Ricambi  
Spare parts

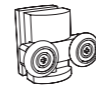
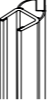

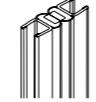

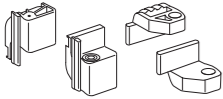
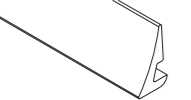

|   |   |                  |                       |   |
|---|---|------------------|-----------------------|---|
|    | Magnete ricoperto L 210<br>Coated magnet L 210  | Cod.             | Nr pezzi<br>Nr pieces | € |
|   |   | <b>37R019015</b> | <b>1</b>              |   |
|    | Guarnizione doppia aletta L 100<br>Double fin seal L 100  | Cod.             | Nr pezzi<br>Nr pieces | € |
|   |   | <b>37R019022</b> | <b>1</b>              |   |
|    | Guarnizione verticale pinna perpend. 20 mm per DM-AR55 e DM-T55 L 190<br>Vertical fin seal 20 mm for DM-AR55 and DM-T55 L 190 | Cod.             | Nr pezzi<br>Nr pieces | € |
|   |   | <b>37R019083</b> | <b>1</b>              |   |
|    | Magnete bipolare 90° L 200<br>Bipolar magnet 90° L 200  | Cod.             | Nr pezzi<br>Nr pieces | € |
|   |   | <b>37R019330</b> | <b>1</b>              |   |
|    | Guarnizione verticale pinna perpendicolare 10 mm L 210<br>Vertical fin seal 10 mm L 210                                       | Cod.             | Nr pezzi<br>Nr pieces | € |
|   |   | <b>37R019102</b> | <b>1</b>              |   |
|    | Finecorsa grigio<br>Shock absorber  | Cod.             | Nr pezzi<br>Nr pieces | € |
|   |   | <b>37R019109</b> | <b>2+2</b>            |   |
|   | Guarnizione verticale palloncino L 210<br>Vertical tubular seal L 210   | Cod.             | Nr pezzi<br>Nr pieces | € |
|   |   | <b>37R019115</b> | <b>1</b>              |   |
|  | Guarnizione verticale pinna parallela L 202<br>Vertical parallel fin seal L 202   | Cod.             | Nr pezzi<br>Nr pieces | € |
|   |   | <b>37R019127</b> | <b>1</b>              |   |
|  | Guarnizione fermavetro pvc L 72<br>Glass seal PVC L 72  | Cod.             | Nr pezzi<br>Nr pieces | € |
|   |   | <b>37R019143</b> | <b>2</b>              |   |
|  | Carrelli in acciaio con ruote<br>Stainless steel wheels   | Cod.             | Nr pezzi<br>Nr pieces | € |
|   |   | <b>37R019384</b> | <b>2</b>              |   |
|  | Ganci inferiori grigi<br>Lower clips grey   | Cod.             | Nr pezzi<br>Nr pieces | € |
|   |   | <b>37R019145</b> | <b>2</b>              |   |
|  | Guarnizione verticale pinna perpendicolare 16 mm L 205<br>Vertical fin seal 16 mm L 205                                       | Cod.             | Nr pezzi<br>Nr pieces | € |
|   |   | <b>37R019147</b> | <b>1</b>              |   |
|  | Raccordo angolare<br>Corner connection  | Cod.             | Nr pezzi<br>Nr pieces | € |
|   |   | <b>37R019215</b> | <b>1</b>              |   |
|  | Perno incernierato porte<br>Pivot hinge doors   | Cod.             | Nr pezzi<br>Nr pieces | € |
|   |   | <b>37R019244</b> | <b>1</b>              |   |
|  | Guarnizione pinna centrale 8 mm L 210<br>Central fin seal 8 mm L 210  | Cod.             | Nr pezzi<br>Nr pieces | € |
|   |   | <b>37R019245</b> | <b>1</b>              |   |

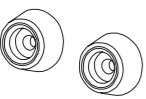
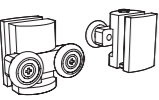
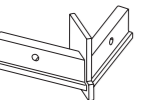
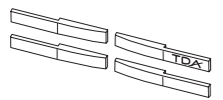
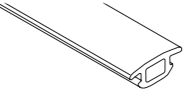
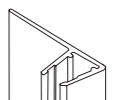
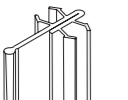
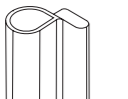
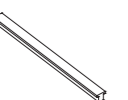
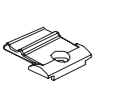

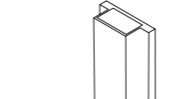
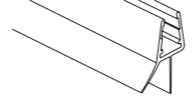
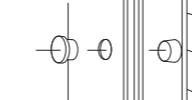
# Dado Maxi



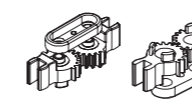
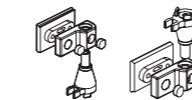
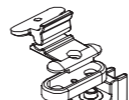
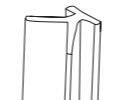

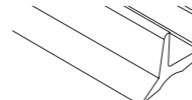
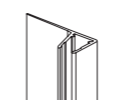
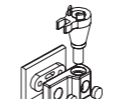
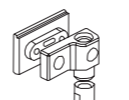
Ricambi  
Spare parts

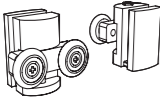
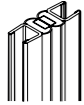

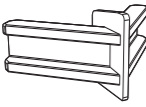

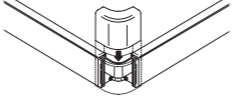
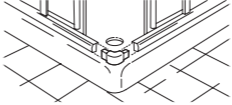
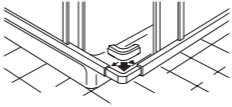
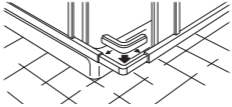
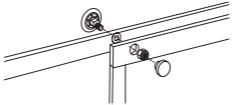
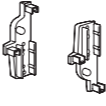

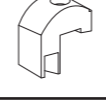
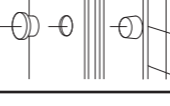
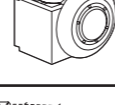
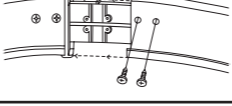
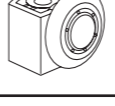
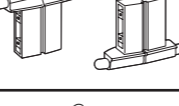
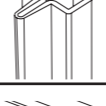
|   |   |                  |                       |   |
|---|---|------------------|-----------------------|---|
|    | Fermo magnetico centrale per DM-PSA2<br>Central magnetic lock for DM-PSA2 | Cod.             | Nr pezzi<br>Nr pieces | € |
|   |   | <b>37R019246</b> | <b>1</b>              |   |
|    | Magnete ricoperto di battuta L 210<br>Coated closing magnet L 210         | Cod.             | Nr pezzi<br>Nr pieces | € |
|   |   | <b>37R019255</b> | <b>1</b>              |   |
|    | Cerniera<br>Hing  | Cod.             | Nr pezzi<br>Nr pieces | € |
|   |   | <b>37R019263</b> | <b>1</b>              |   |
|    | Perno inferiore per DM-PSM<br>Lower pivot hinge for DM-PSM                | Cod.             | Nr pezzi<br>Nr pieces | € |
|   |   | <b>37R019266</b> | <b>1</b>              |   |
|    | Blocco di scancio per DM-PSM<br>Unlocking system for DM-PSM               | Cod.             | Nr pezzi<br>Nr pieces | € |
|   |   | <b>37R019267</b> | <b>1</b>              |   |
|    | Carrelli per DM-T38 e DM-GI<br>Wheels for DM-T38 and DM-GI                | Cod.             | Nr pezzi<br>Nr pieces | € |
|   |   | <b>37R019319</b> | <b>2+2</b>            |   |
|   | Tappi finecorsa<br>Caps for shock absorber                                | Cod.             | Nr pezzi<br>Nr pieces | € |
|   |   | <b>37R019320</b> | <b>2</b>              |   |
|  | Tappi per profilo magnetico<br>Caps for magnetic profile                  | Cod.             | Nr pezzi<br>Nr pieces | € |
|   |   | <b>37R019321</b> | <b>2</b>              |   |
|  | Carrelli per DM-T55 e DM-AR<br>Wheels for DM-T55 and DM-AR                | Cod.             | Nr pezzi<br>Nr pieces | € |
|   |   | <b>37R019322</b> | <b>2+2</b>            |   |
|  | Magnete bipolare 45° L 210<br>Bipolar magnet 45° L 210                    | Cod.             | Nr pezzi<br>Nr pieces | € |
|   |   | <b>37R019323</b> | <b>1</b>              |   |
|  | Scorrimento<br>Sliding kit  | Cod.             | Nr pezzi<br>Nr pieces | € |
|   |   | <b>37R019325</b> | <b>1</b>              |   |
|  | Coppia di magneti bipolari 90° L 200<br>2 x Bipolar magnet 90° L 200      | Cod.             | Nr pezzi<br>Nr pieces | € |
|   |   | <b>37R019327</b> | <b>1</b>              |   |
|  | Maniglia doppia esterna/interna<br>Double internal/external handle        | Cod.             | Nr pezzi<br>Nr pieces | € |
|   |   | <b>37R019380</b> | <b>1</b>              |   |
|  | Maniglia esterna + pomolo interno<br>External handle + internal knob      | Cod.             | Nr pezzi<br>Nr pieces | € |
|   |   | <b>37R019381</b> | <b>1</b>              |   |



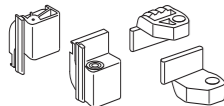
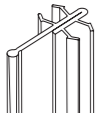
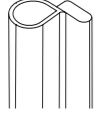
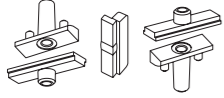

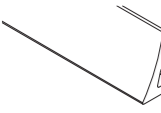

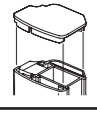
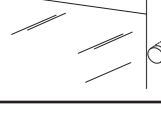

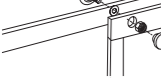
|   |   |                          |                                     |   |
|---|---|--------------------------|-------------------------------------|---|
|    | Perni e pattini per DN-PSO<br>Pivots and gliders for DN-PSO                             | Cod.<br><b>37R019042</b> | Nr pezzi<br>Nr pieces<br><b>2+2</b> | € |
|    | Guarnizione fermavetro per vetro L 10 m<br>Rubber seal for glass L 10 m                 | Cod.<br><b>37R019075</b> | Nr pezzi<br>Nr pieces<br><b>1</b>   | € |
|    | Viteria fissaggio profili<br>Screws for profiles fixing                                 | Cod.<br><b>37R019112</b> | Nr pezzi<br>Nr pieces<br><b>1</b>   | € |
|    | Tappi finecorsa<br>Caps for shock absorber  | Cod.<br><b>37R019320</b> | Nr pezzi<br>Nr pieces<br><b>2</b>   | € |
|    | Carrelli<br>Wheels  | Cod.<br><b>37R019351</b> | Nr pezzi<br>Nr pieces<br><b>2+2</b> | € |
|    | Raccordo angolare<br>Corner connection  | Cod.<br><b>37R019352</b> | Nr pezzi<br>Nr pieces<br><b>2</b>   | € |
|   | Raccordi<br>Connection parts  | Cod.<br><b>37R019353</b> | Nr pezzi<br>Nr pieces<br><b>4</b>   | € |
|  | Guarnizione PVC per binari L 100<br>PVC seal for rails L 100                            | Cod.<br><b>37R019354</b> | Nr pezzi<br>Nr pieces<br><b>1</b>   | € |
|  | Guarnizione verticale pinna perpendicolare 20 mm L 192<br>Vertical fin seal 20 mm L 192 | Cod.<br><b>37R019355</b> | Nr pezzi<br>Nr pieces<br><b>1</b>   | € |
|  | Guarnizione centrale per DN-PSO<br>Central seal for DN-PSO                              | Cod.<br><b>37R019356</b> | Nr pezzi<br>Nr pieces<br><b>1</b>   | € |
|  | Guarnizione laterale per DN-PSO<br>Side seal for DN-PSO                                 | Cod.<br><b>37R019357</b> | Nr pezzi<br>Nr pieces<br><b>1</b>   | € |
|  | Maniglia per DN-PSO<br>Handle for DN-PSO  | Cod.<br><b>37R019358</b> | Nr pezzi<br>Nr pieces<br><b>1</b>   | € |
|  | Chiusura ante per DN-PSA2<br>Door closing for DN-PSA2                                   | Cod.<br><b>37R019362</b> | Nr pezzi<br>Nr pieces<br><b>1</b>   | € |

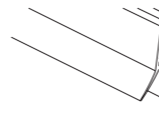
|   |  |                          |                                   |   |
|---|--|--------------------------|-----------------------------------|---|
|    | Magnete ricoperto grigio L 210<br>Coated magnet (grey) L 210                         | Cod.<br><b>37R019015</b> | Nr pezzi<br>Nr pieces<br><b>1</b> | € |
|    | Guarnizione doppia aletta L 100<br>Double fin seal L 100                             | Cod.<br><b>37R019022</b> | Nr pezzi<br>Nr pieces<br><b>1</b> | € |
|    | Tappi copertura<br>Screw caps  | Cod.<br><b>37R019024</b> | Nr pezzi<br>Nr pieces<br><b>4</b> | € |
|    | Tappi finecorsa<br>Caps for shock absorber   | Cod.<br><b>37R019320</b> | Nr pezzi<br>Nr pieces<br><b>2</b> | € |
|    | Viteria fissaggio profili<br>Screws for profiles fixing                              | Cod.<br><b>37R019112</b> | Nr pezzi<br>Nr pieces<br><b>1</b> | € |
|    | Guarnizione verticale tenuta L 190<br>Vertical anti-leakage seal L 190               | Cod.<br><b>37R019118</b> | Nr pezzi<br>Nr pieces<br><b>1</b> | € |
|   | Ingranaggi per SD-PSO<br>Mechanisms for SD-PSO                                       | Cod.<br><b>37R019120</b> | Nr pezzi<br>Nr pieces<br><b>4</b> | € |
|  | Cerniera per SD-PSO<br>Hinge for SD-PSO  | Cod.<br><b>37R019121</b> | Nr pezzi<br>Nr pieces<br><b>2</b> | € |
|  | Chiusura ante per SD-PSO<br>Door closing for SD-PSO                                  | Cod.<br><b>37R019122</b> | Nr pezzi<br>Nr pieces<br><b>2</b> | € |
|  | Guarnizione verticale maniglia SD-PSO L 190<br>Vertical seal for handle SD-PSO L 190 | Cod.<br><b>37R019123</b> | Nr pezzi<br>Nr pieces<br><b>1</b> | € |
|  | Maniglia<br>Handle   | Cod.<br><b>37R019142</b> | Nr pezzi<br>Nr pieces<br><b>1</b> | € |
|  | Guarnizione fermavetro pvc L 72<br>Glass seal PVC L 72                               | Cod.<br><b>37R019143</b> | Nr pezzi<br>Nr pieces<br><b>2</b> | € |
|  | Guarnizione verticale a pinna L 205<br>Vertical fin seal L 205                       | Cod.<br><b>37R019147</b> | Nr pezzi<br>Nr pieces<br><b>1</b> | € |
|  | Gruppo scorrimento per SD-PSO<br>Sliding kit for SD-PSO                              | Cod.<br><b>37R019227</b> | Nr pezzi<br>Nr pieces<br><b>1</b> | € |
|  | Fermo centrale per SD-PSA2<br>Central lock for SD-PSA2                               | Cod.<br><b>37R019308</b> | Nr pezzi<br>Nr pieces<br><b>1</b> | € |

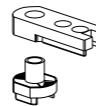
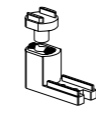
|   |  |                  |                       |   |
|---|--|------------------|-----------------------|---|
|  | Carrelli per anta scorrevole<br>Wheels for sliding door              | Cod.             | Nr pezzi<br>Nr pieces | € |
|   |  | <b>37R019319</b> | <b>2+2</b>            |   |
|  | Coppia di magneti bipolari 90° L 190<br>2 x Bipolar magnet 90° L 190 | Cod.             | Nr pezzi<br>Nr pieces | € |
|   |  | <b>37R019328</b> | <b>1</b>              |   |
|  | Coppia di magneti bipolari 45° L 190<br>2 x Bipolar magnet 45° L 190 | Cod.             | Nr pezzi<br>Nr pieces | € |
|   |  | <b>37R019332</b> | <b>1</b>              |   |
|  | Raccordo angolare<br>Corner connection                               | Cod.             | Nr pezzi<br>Nr pieces | € |
|   |  | <b>37R019379</b> | <b>2</b>              |   |

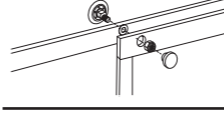
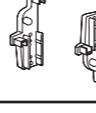
|   |   |                  |                       |   |
|---|---|------------------|-----------------------|---|
|    | Raccordo angolare per CO-ASCT<br>Corner connection for CO-ASCT                    | Cod.             | Nr pezzi<br>Nr pieces | € |
|   |   | <b>37R019006</b> | <b>1</b>              |   |
|    | Raccordo angolare per CO-ASCR<br>Corner connection for CO-ASCR                    | Cod.             | Nr pezzi<br>Nr pieces | € |
|   |   | <b>37R019007</b> | <b>2</b>              |   |
|    | Raccordo angolare per CO-ASCS<br>Corner connection for CO-ASCS                    | Cod.             | Nr pezzi<br>Nr pieces | € |
|   |   | <b>37R019008</b> | <b>1</b>              |   |
|    | Raccordo angolare per CO-ASCV<br>Corner connection for CO-ASCV                    | Cod.             | Nr pezzi<br>Nr pieces | € |
|   |   | <b>37R019009</b> | <b>1</b>              |   |
|    | Cuscinetti a sfera eccentrici<br>Eccentric ball bearings                          | Cod.             | Nr pezzi<br>Nr pieces | € |
|   |   | <b>37R019010</b> | <b>4</b>              |   |
|    | Tappi finecorsa per CO-ASCT<br>Caps for CO-ASCT shock absorber                    | Cod.             | Nr pezzi<br>Nr pieces | € |
|   |   | <b>37R019012</b> | <b>2</b>              |   |
|   | Gruppo scorrimento ruote per CO-ASCS<br>Wheels sliding set for CO-ASCS            | Cod.             | Nr pezzi<br>Nr pieces | € |
|   |   | <b>37R019017</b> | <b>4</b>              |   |
|  | Pattini per CO-ASCV<br>Gliders for CO-ASCV  | Cod.             | Nr pezzi<br>Nr pieces | € |
|   |   | <b>37R019018</b> | <b>4</b>              |   |
|  | Tappi copertura<br>Screw caps   | Cod.             | Nr pezzi<br>Nr pieces | € |
|   |   | <b>37R019024</b> | <b>4</b>              |   |
|  | Gruppo scorrimento ruote per CO-PSC<br>Wheels sliding set for CO-PSC              | Cod.             | Nr pezzi<br>Nr pieces | € |
|   |   | <b>37R019026</b> | <b>4</b>              |   |
|  | Giunto centrale per Elba<br>Central joint for Elba                                | Cod.             | Nr pezzi<br>Nr pieces | € |
|   |   | <b>37R019027</b> | <b>2</b>              |   |
|  | Gruppo scorrimento ruote per Elba / Golfo<br>Wheels sliding set for Elba / Golfo  | Cod.             | Nr pezzi<br>Nr pieces | € |
|   |   | <b>37R019028</b> | <b>8</b>              |   |
|  | Cerniere per Spazio<br>Hinges for CO-SVM / Spazio                                 | Cod.             | Nr pezzi<br>Nr pieces | € |
|   |   | <b>37R019033</b> | <b>4</b>              |   |
|  | Guarnizione verticale per Spazio L 180<br>Vertical seal for CO-SVM / Spazio L 180 | Cod.             | Nr pezzi<br>Nr pieces | € |
|   |   | <b>37R019034</b> | <b>1</b>              |   |
|  | Guarnizione orizzontale per Spazio L 145<br>Horizontal seal for Spazio L 145      | Cod.             | Nr pezzi<br>Nr pieces | € |
|   |   | <b>37R019035</b> | <b>1</b>              |   |

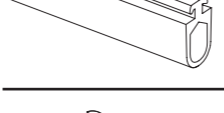
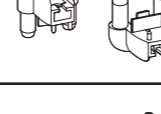
|   |   |                          |                                     |   |
|---|---|--------------------------|-------------------------------------|---|
|    | Perni e pattini per CO-PSO<br>Pivots and gliders for CO-PSO                           | Cod.<br><b>37R019042</b> | Nr pezzi<br>Nr pieces<br><b>2+2</b> | € |
|    | Guarnizione centrale per CO-PSO L 184,5<br>Central seal for CO-PSO L 184,5            | Cod.<br><b>37R019044</b> | Nr pezzi<br>Nr pieces<br><b>1</b>   | € |
|    | Guarnizione laterale per CO-PSO / CO-PGI L 187<br>Side seal for CO-PSO / CO-PGI L 187 | Cod.<br><b>37R019045</b> | Nr pezzi<br>Nr pieces<br><b>1</b>   | € |
|    | Perni per CO-PGI<br>Pivot hinge for CO-PGI  | Cod.<br><b>37R019046</b> | Nr pezzi<br>Nr pieces<br><b>2</b>   | € |
|    | Maniglia per CO-PSO<br>Handle for CO-PSO  | Cod.<br><b>37R019048</b> | Nr pezzi<br>Nr pieces<br><b>1</b>   | € |
|    | Guarnizione fermavetro per acrilico L 10 m<br>Rubber seal for acrylic sheet L 10 m    | Cod.<br><b>37R019074</b> | Nr pezzi<br>Nr pieces<br><b>1</b>   | € |
|   | Guarnizione fermavetro per vetro L 10 m<br>Rubber seal for glass L 10 m               | Cod.<br><b>37R019075</b> | Nr pezzi<br>Nr pieces<br><b>1</b>   | € |
|  | Tappi copertura profili per Spazio<br>Caps for Spazio profiles                        | Cod.<br><b>37R019084</b> | Nr pezzi<br>Nr pieces<br><b>2</b>   | € |
|  | 4 x Viteria fissaggio profili<br>4 x Screws for profiles fixing                       | Cod.<br><b>37R019112</b> | Nr pezzi<br>Nr pieces<br><b>1</b>   | € |
|  | Guarnizione per CO-PGI L 100<br>Seal for CO-PGI L 100                                 | Cod.<br><b>37R019116</b> | Nr pezzi<br>Nr pieces<br><b>1</b>   | € |
|  | Ruote eccentriche per CO-ASCR<br>Eccentric wheels for CO-ASCR                         | Cod.<br><b>37R019242</b> | Nr pezzi<br>Nr pieces<br><b>4</b>   | € |

|   |   |                          |                                     |   |
|---|---|--------------------------|-------------------------------------|---|
|    | Supporto standard vetro-muro L 100 (con deviatore)<br>L 100 cm return to wall bar + T connection part | Cod.<br><b>36S117002</b> | Nr pezzi<br>Nr pieces<br><b>1</b>   | € |
|    | Guarnizione doppia aletta L 100<br>Double fin seal L 100  | Cod.<br><b>37R019022</b> | Nr pezzi<br>Nr pieces<br><b>1</b>   | € |
|    | Guarnizione fermavetro per IT-SV L 230<br>Rubber seal for IT-SV L 230                                 | Cod.<br><b>37R019221</b> | Nr pezzi<br>Nr pieces<br><b>1</b>   | € |
|    | Tappi copertura<br>Screw caps   | Cod.<br><b>37R019243</b> | Nr pezzi<br>Nr pieces<br><b>2</b>   | € |
|    | Perno superiore per MO-SV e MI-SV<br>Upper hinge for MO-SV and MI-SV                                  | Cod.<br><b>37R019292</b> | Nr pezzi<br>Nr pieces<br><b>1</b>   | € |
|    | Perno inferiore<br>Lower pivot hinge  | Cod.<br><b>37R019293</b> | Nr pezzi<br>Nr pieces<br><b>1</b>   | € |
|   | Guarnizione verticale tenuta L 200<br>Vertical anti-leakage seal L 200                                | Cod.<br><b>37R019296</b> | Nr pezzi<br>Nr pieces<br><b>1</b>   | € |
|  | Cuscinetti a sfera eccentrici<br>Eccentric ball bearings  | Cod.<br><b>37R019010</b> | Nr pezzi<br>Nr pieces<br><b>4</b>   | € |
|  | Tappi finecorsa per CO-VSC<br>Caps for CO-VSC shock absorber  | Cod.<br><b>37R019012</b> | Nr pezzi<br>Nr pieces<br><b>2</b>   | € |
|  | Tappi copertura<br>Screw caps   | Cod.<br><b>37R019024</b> | Nr pezzi<br>Nr pieces<br><b>4</b>   | € |
|  | Guarnizione orizzontale per CO-SVF L 145<br>Horizontal seal for CO-SVF L145                           | Cod.<br><b>37R019035</b> | Nr pezzi<br>Nr pieces<br><b>1</b>   | € |
|  | Cerniere anta per CO-SVF<br>Glass hinges for CO-SVF   | Cod.<br><b>37R019036</b> | Nr pezzi<br>Nr pieces<br><b>1</b>   | € |
|  | Cerniere muro per CO-SVF<br>Wall hinges for CO-SVF  | Cod.<br><b>37R019037</b> | Nr pezzi<br>Nr pieces<br><b>1+1</b> | € |

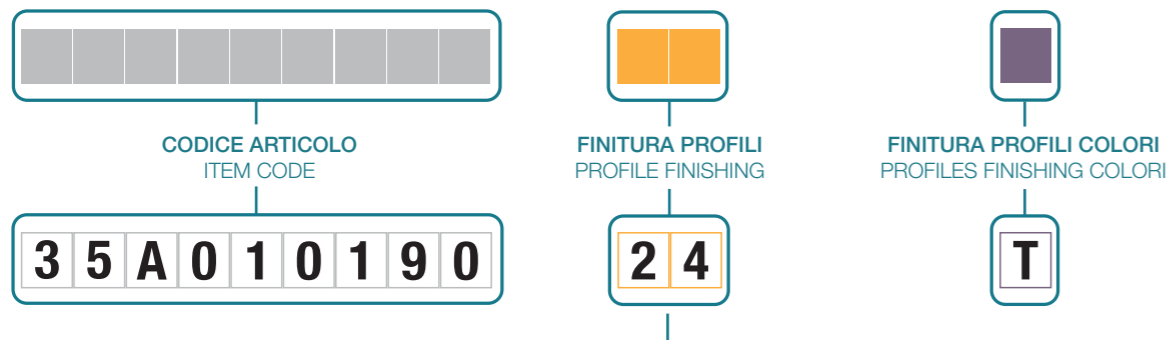
**COMPOSIZIONE CODICE ARTICOLO**  
 ITEM CODE COMPOSITION

| ORIGIN      | ABITAT     | VOGUE          | INOX            |
|-------------|------------|----------------|-----------------|
| 20 RAL 9010 | 21 Tinox®  | 61 Orosatinato | 64 Franciacorta |
| 59 Nero     | 22 Tbronz® | 62 Ororosa     | 65 Rame         |
| 60 Bianco   | 24 Tbrill® | 63 Cromonero   | 66 Brownie      |
|             | 27 Tcrom®  | Colori         |                 |

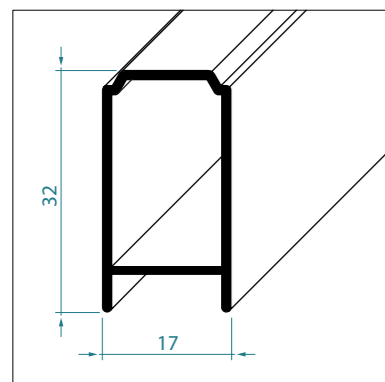

Utilizzabile per i modelli FONT, DADO MAXI, SPADO e COMFORT  
 Suitable for FONT, DADO MAXI and COMFORT models

| Codice Code | H cm            | Prezzo Price |
|-------------|-----------------|--------------|
| 35A010150   | 150             |              |
| 35A010190   | 190             |              |
| 35A010200   | 200             |              |
| 35A019001   | special max 210 |              |

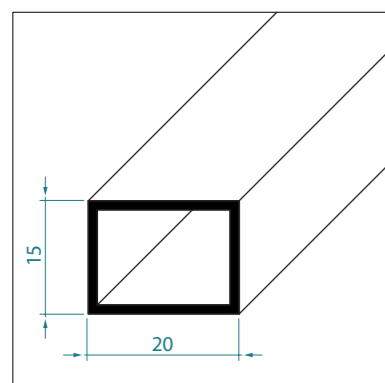

Utilizzabile per i modelli PLUMA, GAIA e VOLO  
 Suitable for PLUMA, GAIA and VOLO models

| Codice Code | H cm            | Prezzo Price |
|-------------|-----------------|--------------|
| 37P019219   | 200             |              |
| 37P019220   | special max 210 |              |

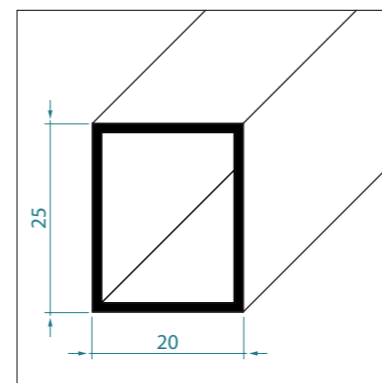

Utilizzabile per i modelli MORK, MINDY e VOLO  
 Suitable for MORK, MINDY and VOLO models

| Codice Code | H cm            | Prezzo Price |
|-------------|-----------------|--------------|
| 37P019221   | 200             |              |
| 37P019222   | special max 210 |              |

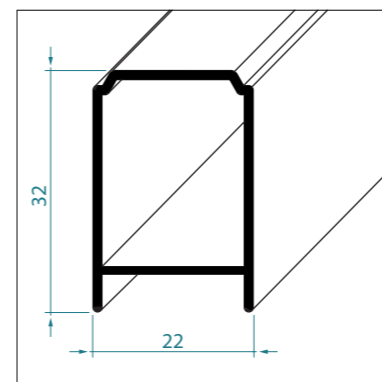

Utilizzabile per il modello DINO  
 Suitable for DINO model

| Codice Code | H cm            | Prezzo Price |
|-------------|-----------------|--------------|
| 35A080200   | 200             |              |
| 35A089001   | special max 200 |              |

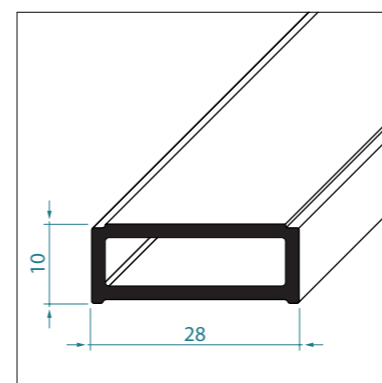

Utilizzabile per il modello ELIO  
 Suitable for ELIO model

| Codice Code | H cm            | Prezzo Price |
|-------------|-----------------|--------------|
| 35A020200   | 200             |              |
| 35A029001   | special max 210 |              |

## ATTACCO LATERALE

SPECIAL PROFILES - CONNECTIONS

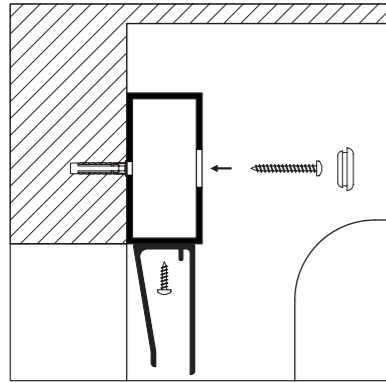

Utilizzabile per i modelli ITALO, VITO, ROCCO, FRIGO, PLUMA, GAIA e VOLO  
Suitable for ITALO, VITO, ROCCO, FRIGO, PLUMA, GAIA and VOLO models

| Codice<br>Code   | H cm             | Prezzo<br>Price |
|------------------|------------------|-----------------|
| <b>35M140200</b> | 200 (40 x 20 mm) |                 |
| <b>35M149001</b> | special max 210  |                 |

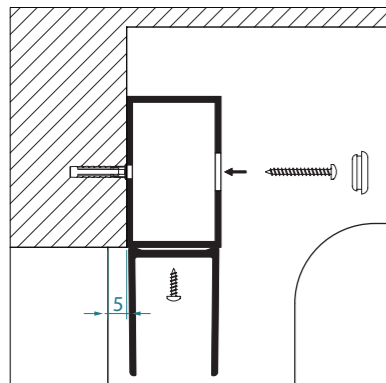

Utilizzabile per i modelli MORK, MINDY e VOLO  
Suitable for MORK, MINDY and VOLO models

| Codice<br>Code   | H cm             | Prezzo<br>Price |
|------------------|------------------|-----------------|
| <b>35M150200</b> | 200 (40 x 25 mm) |                 |
| <b>35M159001</b> | special max 210  |                 |

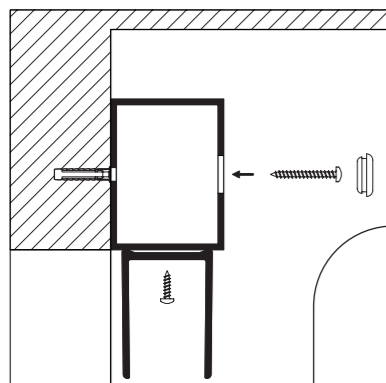

Utilizzabile per i modelli MORK, MINDY, ELIO, FRIGO e VOLO  
Suitable for MORK, MINDY, ELIO, FRIGO and VOLO models

| Codice<br>Code   | H cm             | Prezzo<br>Price |
|------------------|------------------|-----------------|
| <b>35M160200</b> | 200 (40 x 30 mm) |                 |
| <b>35M169001</b> | special max 210  |                 |

## ATTACCO LATERALE

SPECIAL PROFILES - CONNECTIONS

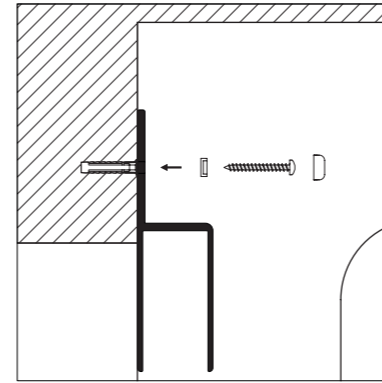

Utilizzabile per i modelli FONT, DADO MAXI, SPADO e COMFORT  
Suitable for FONT, DADO MAXI, SPADO and VOLO models

| Codice<br>Code                     | H cm            | Prezzo<br>Price |
|------------------------------------|-----------------|-----------------|
| <b>35M040190</b>                   | 190             |                 |
| <b>35M040200</b>                   | 200             |                 |
| <b>35M049001</b>                   | special max 210 |                 |
| <b>35M039001</b> MORK, MINDY, VOLO | special max 210 |                 |

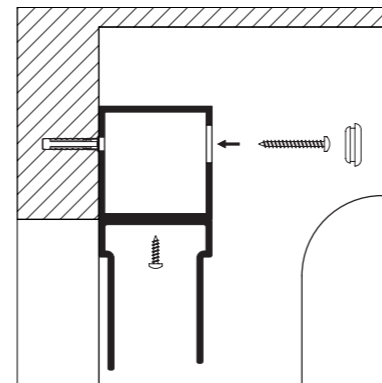

Utilizzabile per il modello DINO  
Suitable for DINO model

| Codice<br>Code   | H cm            | Prezzo<br>Price |
|------------------|-----------------|-----------------|
| <b>35M050200</b> | 200             |                 |
| <b>35M059001</b> | special max 210 |                 |

## PROFILI A SNODO

### ARTICULATED PROFILES

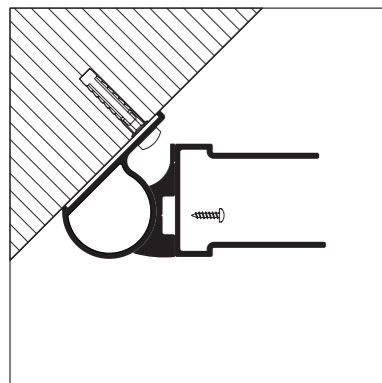

Utilizzabile per i modelli MORK, MINDY, ELIO, FRIGO, DINO e VOLO  
Suitable for MORK, MINDY, ELIO, FRIGO, DINO and VOLO models

| Codice<br>Code            | H cm                         | Prezzo<br>Price |
|---------------------------|------------------------------|-----------------|
| <a href="#">37P019232</a> | 200 (base 30 mm)             |                 |
| <a href="#">37P019234</a> | special max 210 (base 30 mm) |                 |

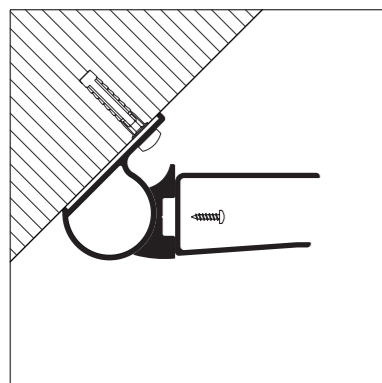

Utilizzabile per i modelli MORK, MINDY, DADO MAXI, FONT, SPADO, COMFORT e VOLO  
Suitable for MORK, MINDY, DADO MAXI, FONT, SPADO, COMFORT and VOLO models

| Codice<br>Code            | H cm                         | Prezzo<br>Price |
|---------------------------|------------------------------|-----------------|
| <a href="#">37P019236</a> | 190 (base 25 mm)             |                 |
| <a href="#">37P019238</a> | 200 (base 25 mm)             |                 |
| <a href="#">37P019240</a> | special max 210 (base 25 mm) |                 |

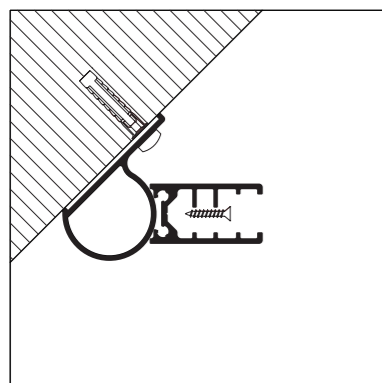

Utilizzabile per i modelli ITALO, VITO e ROCCO  
Suitable for ITALO, VITO and ROCCO models

| Codice<br>Code            | H cm                         | Prezzo<br>Price |
|---------------------------|------------------------------|-----------------|
| <a href="#">37P019242</a> | 200 (base 20 mm)             |                 |
| <a href="#">37P019246</a> | special max 210 (base 20 mm) |                 |

## PROFILI A SNODO

### ARTICULATED PROFILES

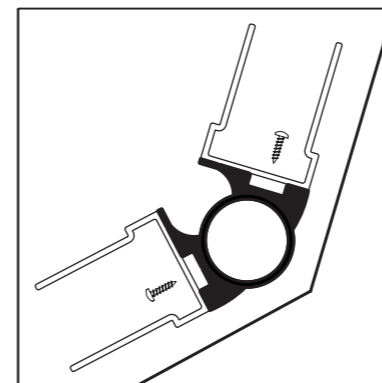

Utilizzabile per i modelli MORK, MINDY, ELIO, FRIGO, DINO e VOLO  
Suitable for MORK, MINDY, ELIO, FRIGO, DINO and VOLO models

| Codice<br>Code            | H cm                        | Prezzo<br>Price |
|---------------------------|-----------------------------|-----------------|
| <a href="#">37P019250</a> | 210 max (base / base 30 mm) |                 |

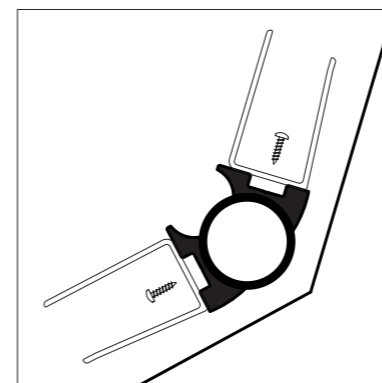

Utilizzabile per i modelli MORK, MINDY, DADO MAXI, FONT, SPADO e COMFORT  
Suitable for MORK, MINDY, DADO MAXI, FONT, SPADO and COMFORT models

| Codice<br>Code            | H cm                        | Prezzo<br>Price |
|---------------------------|-----------------------------|-----------------|
| <a href="#">37P019252</a> | 210 max (base / base 25 mm) |                 |

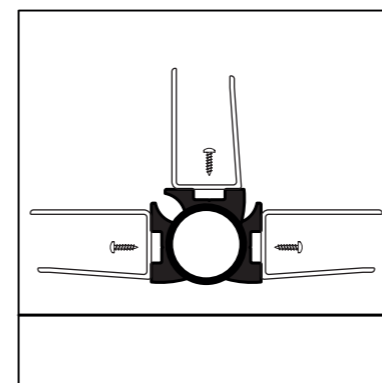

Utilizzabile per i modelli DADO MAXI, FONT, SPADO e COMFORT  
Suitable for DADO MAXI, FONT, SPADO and COMFORT models

| Codice<br>Code            | H cm                        | Prezzo<br>Price |
|---------------------------|-----------------------------|-----------------|
| <a href="#">37P019254</a> | 210 max (base / base 25 mm) |                 |

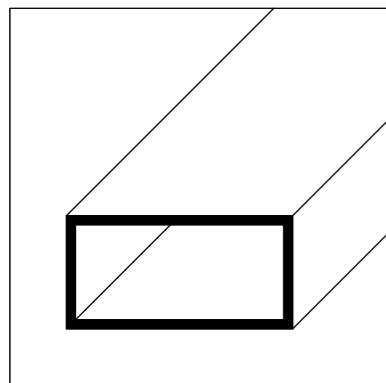
**PROFILI SPECIALI**  
 SPECIAL PROFILES

PROFILO TUBOLARE Utilizzabile su tutti i modelli  
 TUBULAR PROFILE Suitable for all models

| Codice<br>Code | H cm                          | Prezzo<br>Price |
|----------------|-------------------------------|-----------------|
| 35T009002      | special max 210 (20 x 10 mm)  |                 |
| 35T009004      | special max 210 (30 x 10 mm)  |                 |
| 35T009006      | special max 210 (30 x 20 mm)  |                 |
| 35T009008      | special max 210 (30 x 30 mm)  |                 |
| 35T009010      | special max 210 (40 x 20 mm)  |                 |
| 35T009011      | special max 210 (40 x 25 mm)  |                 |
| 35T009012      | special max 210 (40 x 30 mm)  |                 |
| 35T009014      | special max 210 (40 x 40 mm)  |                 |
| 35T009016      | special max 210 (45 x 45 mm)  |                 |
| 35T009018      | special max 210 (50 x 20 mm)  |                 |
| 35T009020      | special max 210 (50 x 30 mm)  |                 |
| 35T009022      | special max 210 (60 x 20 mm)  |                 |
| 35T009024      | special max 210 (60 x 30 mm)  |                 |
| 35T009026      | special max 210 (80 x 40 mm)  |                 |
| 35T009028      | special max 210 (100 x 30 mm) |                 |

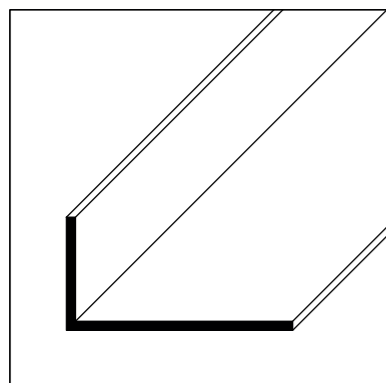

PROFILO ANGOLARE Utilizzabile su tutti i modelli  
 CORNER PROFILE Suitable for all models

| Codice<br>Code | H cm                         | Prezzo<br>Price |
|----------------|------------------------------|-----------------|
| 35N009016      | special max 210 (20 x 10 mm) |                 |
| 35N009018      | special max 210 (30 x 10 mm) |                 |
| 35N009020      | special max 210 (30 x 15 mm) |                 |
| 35N009002      | special max 210 (30 x 20 mm) |                 |
| 35N009004      | special max 210 (30 x 30 mm) |                 |
| 35N009006      | special max 210 (40 x 20 mm) |                 |
| 35N009008      | special max 210 (45 x 45 mm) |                 |
| 35N009012      | special max 210 (50 x 30 mm) |                 |
| 35N009014      | special max 210 (50 x 50 mm) |                 |
| 35N009022      | special max 210 (60 x 20 mm) |                 |
| 35N009024      | special max 210 (60 x 30 mm) |                 |
| 35N009026      | special max 210 (80 x 40 mm) |                 |

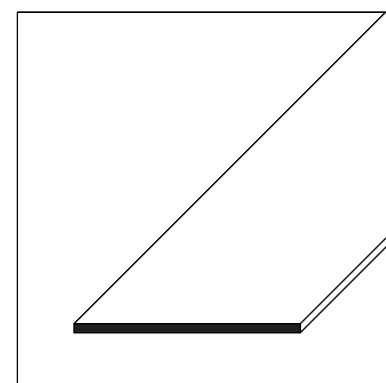

PROFILO PIATTO Utilizzabile su tutti i modelli  
 FLAT PROFILE Suitable for all models

| Codice<br>Code | H cm                        | Prezzo<br>Price |
|----------------|-----------------------------|-----------------|
| 35P009001      | special max 210 (20 x 2 mm) |                 |
| 35P009004      | special max 210 (30 x 2 mm) |                 |
| 35P009007      | special max 210 (60 x 2 mm) |                 |

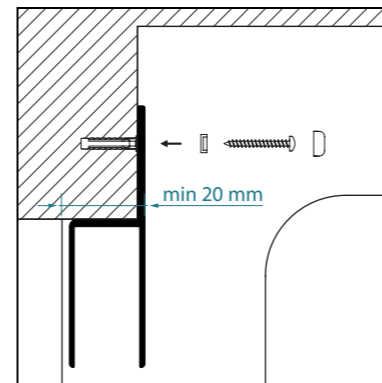
**PROFILI SPECIALI**  
 SPECIAL PROFILES

PROFILO PER ATTACCO FRONTALE INTERNO  
 CORNER PROFILE FOR SIDE CONNECTION

Utilizzabile per i modelli FONT, DADO MAXI, SPADO e COMFORT  
 Suitable for all models FONT, DADO MAXI, SPADO and COMFORT

| Codice<br>Code | H cm              | Prezzo<br>Price |
|----------------|-------------------|-----------------|
| 35M040190      | 190               |                 |
| 35M040200      | 200               |                 |
| 35M049001      | special max 210   |                 |
| 35M039001      | MORK, MINDY, VOLO | special max 210 |

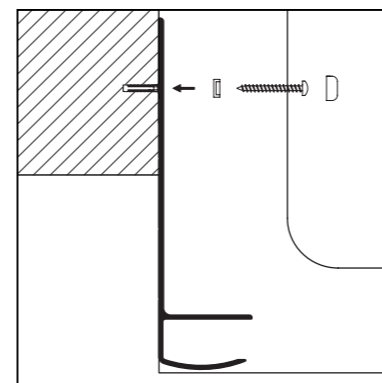

PROFILO ALA LUNGA  
 LONG WINGED SIDE MOUNTING PROFILE

Utilizzabile per i modelli FONT, DADO MAXI, SPADO e COMFORT  
 Suitable for all models FONT, DADO MAXI, SPADO and COMFORT

| Codice<br>Code | L mm | H cm            | Prezzo<br>Price |
|----------------|------|-----------------|-----------------|
| 35N550010      | 60   | 190             |                 |
| 35N550011      | 90   | 190             |                 |
| 35N550012      | 120  | 190             |                 |
| 35N550013      | 150  | 190             |                 |
| 35N550020      | 60   | special max 210 |                 |
| 35N550021      | 90   | special max 210 |                 |
| 35N550022      | 120  | special max 210 |                 |
| 35N550023      | 150  | special max 210 |                 |

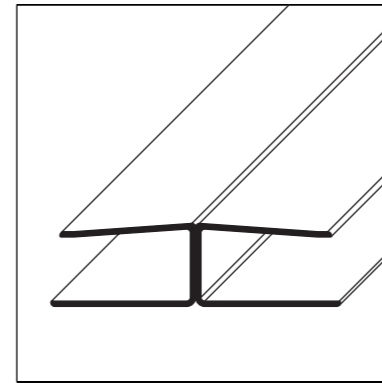

PROFILO PER ATTACCO IN LINEA  
 IN-LINE CONNECTION PROFILE

Utilizzabile per i modelli FONT, DADO MAXI, DINO, SPADO e COMFORT  
 Suitable for all models FONT, DADO MAXI, DINO, SPADO and COMFORT

| Codice<br>Code | H cm                          | Prezzo<br>Price |
|----------------|-------------------------------|-----------------|
| 35M010190      | 190                           |                 |
| 35M019001      | special max 210               |                 |
| 35M019002      | (159) MURETTO / WALLS max 210 |                 |

| Codice<br>Code | H cm                           | Prezzo<br>Price |
|----------------|--------------------------------|-----------------|
| 35M110190      | 190 (1327)                     |                 |
| 35M110200      | 200 (1327)                     |                 |
| 35M119001      | (1327) special max 210         |                 |
| 35M119002      | (1327) MURETTO / WALLS max 210 |                 |

| Codice<br>Code | H cm                           | Prezzo<br>Price |
|----------------|--------------------------------|-----------------|
| 35M130200      | 200 (1401)                     |                 |
| 35M139001      | (1401) special max 210         |                 |
| 35M139002      | (1401) MURETTO / WALLS max 210 |                 |

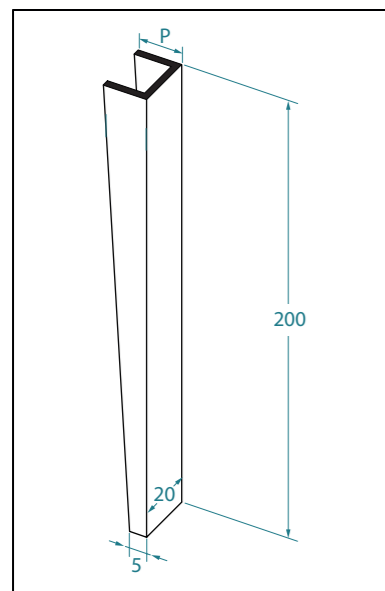
 PROFILO CONICO - L 20 mm  
 TAPERED PROFILE - L 20 mm

 Utilizzabile per i modelli ITALO, VITO, ROCCO, ENZO, FRIGO, PLUMA EVO e GAIA  
 Suitable for all models ITALO, VITO, ROCCO, ENZO, FRIGO, PLUMA EVO and GAIA

| Codice<br>Code   | P mm | H cm                              | Prezzo<br>Price |
|------------------|------|-----------------------------------|-----------------|
| <b>35T020001</b> |      | misure speciali /special measures |                 |
| <b>35T020015</b> | 15   | 200                               |                 |
| <b>35T020025</b> | 25   | 200                               |                 |
| <b>35T020035</b> | 35   | 200                               |                 |
| <b>35T020045</b> | 45   | 200                               |                 |

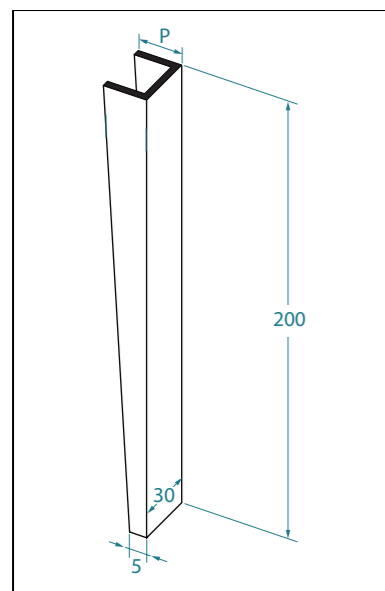
 PROFILO CONICO - L 30 mm  
 TAPERED PROFILE - L 30 mm

 Utilizzabile per i modelli MORK, MINDY, VOLO, FONT, ELIO, DADO MAXI, SPADO, COMFORT e DINO (esclusi i modelli per nicchia)  
 Suitable for all models MORK, MINDY, VOLO, FONT, ELIO, DADO MAXI, SPADO, COMFORT and DINO (niche models excluded)

| Codice<br>Code   | P mm | H cm                              | Prezzo<br>Price |
|------------------|------|-----------------------------------|-----------------|
| <b>35T020001</b> |      | misure speciali /special measures |                 |
| <b>35T030015</b> | 15   | 200                               |                 |
| <b>35T030025</b> | 25   | 200                               |                 |
| <b>35T030035</b> | 35   | 200                               |                 |
| <b>35T030045</b> | 45   | 200                               |                 |

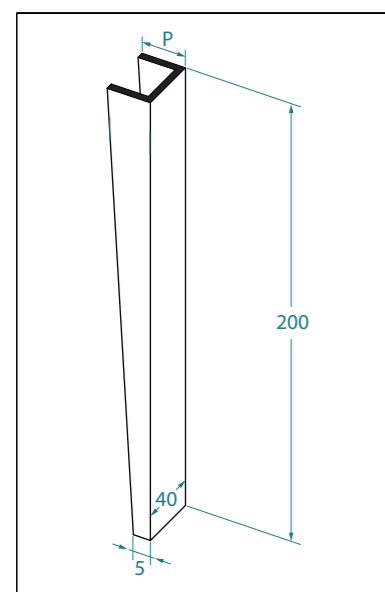
 PROFILO CONICO - L 40 mm  
 TAPERED PROFILE - L 40 mm

 Utilizzabile per i modelli DADO MAXI, SPADO e COMFORT  
 Suitable for all models DADO MAXI, SPADO and COMFORT

| Codice<br>Code   | P mm | H cm                              | Prezzo<br>Price |
|------------------|------|-----------------------------------|-----------------|
| <b>35T020001</b> |      | misure speciali /special measures |                 |
| <b>35T040015</b> | 15   | 200                               |                 |
| <b>35T040025</b> | 25   | 200                               |                 |
| <b>35T040035</b> | 35   | 200                               |                 |
| <b>35T040045</b> | 45   | 200                               |                 |

**RILIEVO MISURE STANDARD**  
STANDARD SIZES MEASUREMENTS

**Installazione a pavimento o con piatto doccia incassato a filo pavimento**  
Floor installation or with built-in shower tray flush with the floor

**1.** per Pareti doccia ad un'anta e a due ante, scorrevoli o a battente

for shower enclosures with one and/or two doors, sliding or pivoting

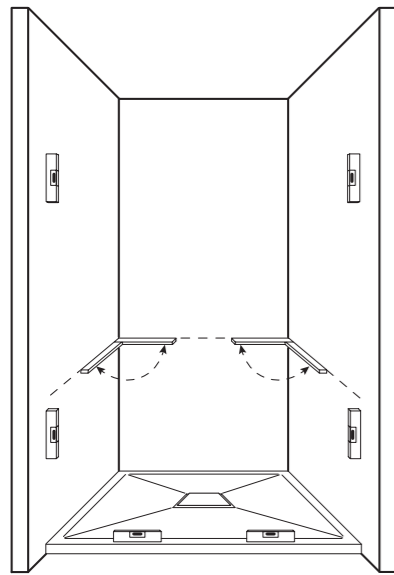

A ..... cm  
B ..... cm  
C ..... cm

**2.** per Pareti doccia ad angolo. Due porte o ad una porta con fisso aggiuntivo

for corner shower enclosures. One or two doors with additional fixed panel

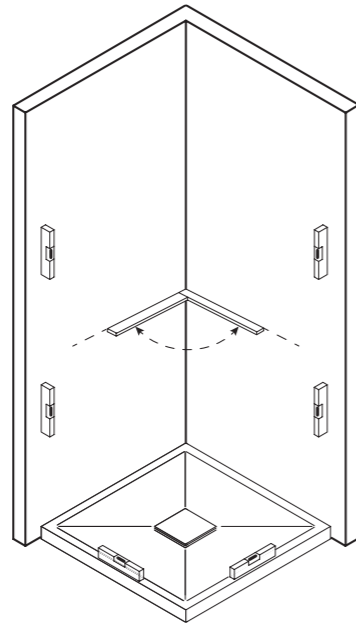

A ..... cm  
B ..... cm  
C ..... cm

**3.** per cabine doccia con una porta e due fissi laterali aggiuntivi o a due porte ed un fisso laterale aggiuntivo

for shower enclosures with one door and two sides fixed panels or with two doors and one additional side fixed panel

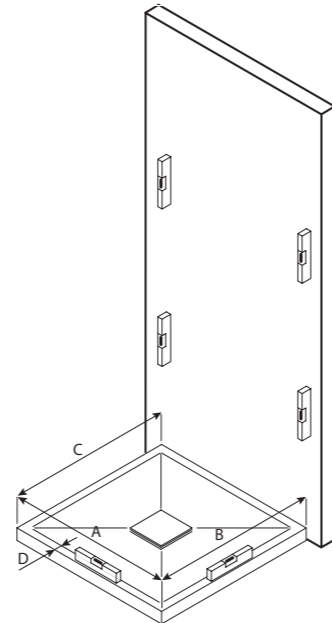

A ..... cm  
B ..... cm  
C ..... cm  
D ..... cm

**4.** per cabine doccia con ante curvate a battente o scorrevoli - Raggio 55 cm

for quadrant shower enclosures - Radius 55 cm

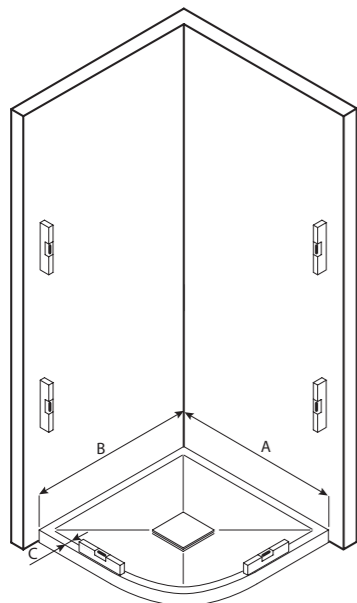

A ..... cm  
B ..... cm  
C ..... cm

**5.** per cabine doccia con ante curvate a battente o scorrevoli - Raggio 38 cm

for quadrant shower enclosures - Radius 38 cm

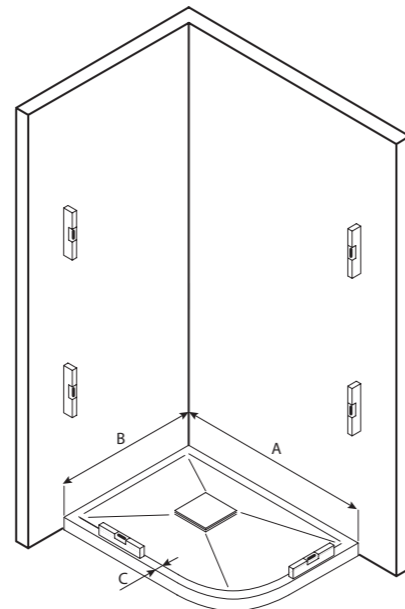

A ..... cm  
B ..... cm  
C ..... cm

**RILIEVO MISURE PARTICOLARI**  
BESPOKE SIZES MEASUREMENTS

**Esempi di rilievo misure per installazione particolari**  
Examples of measurements for special installations

**6.**

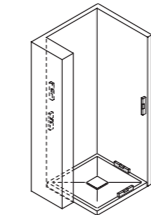
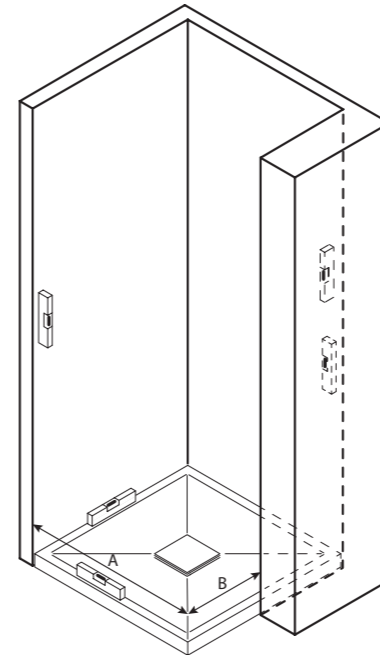

A ..... cm  
B ..... cm

**7.**

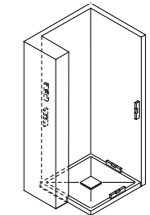
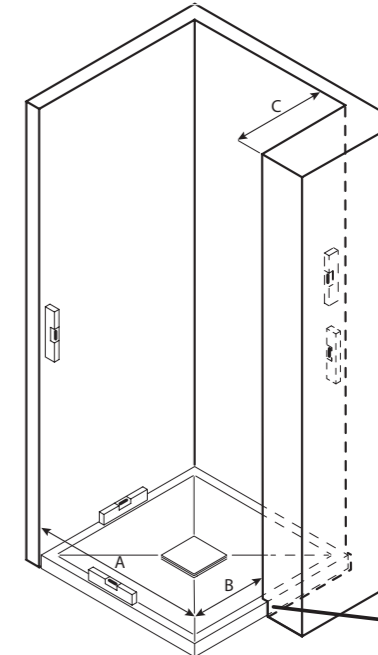

A ..... cm  
B ..... cm  
C ..... cm  
D ..... cm  
E ..... cm

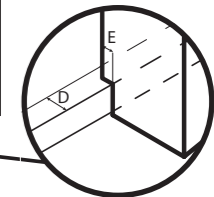

**8.**

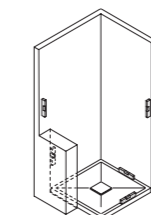
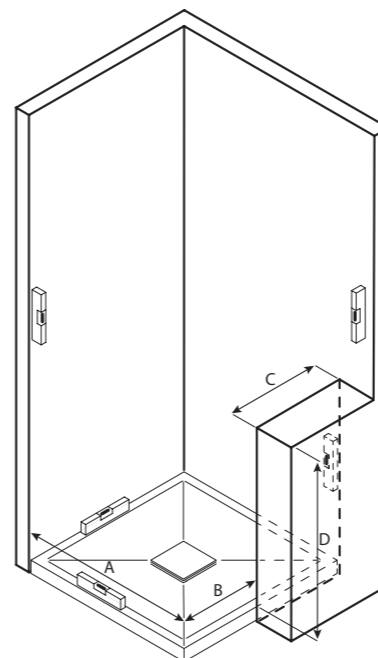

A ..... cm  
B ..... cm  
C ..... cm  
D ..... cm

**9.**

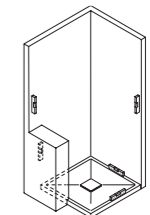
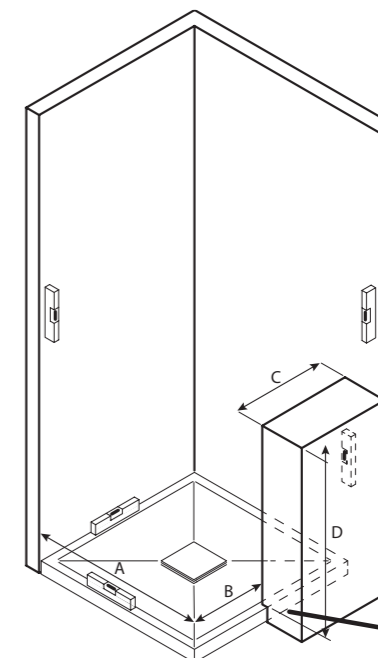

A ..... cm.  
B ..... cm.  
C ..... cm.  
D ..... cm.  
E ..... cm.

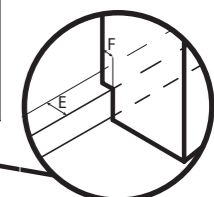

Esempi di rilievo misure per installazione particolari  
Examples of measurements for special installations

10.

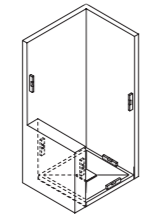
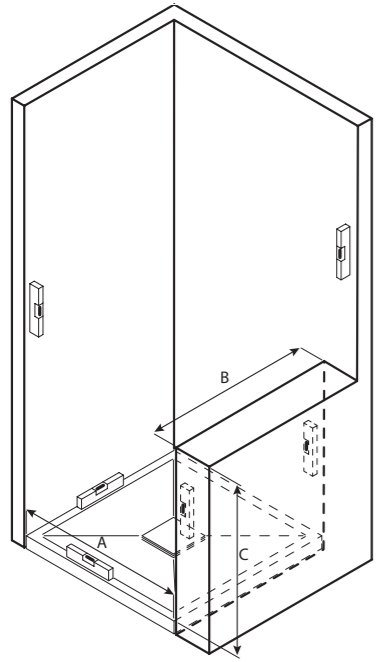

A ..... cm  
B ..... cm  
C ..... cm

11.

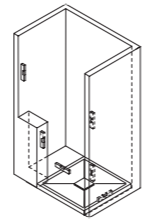
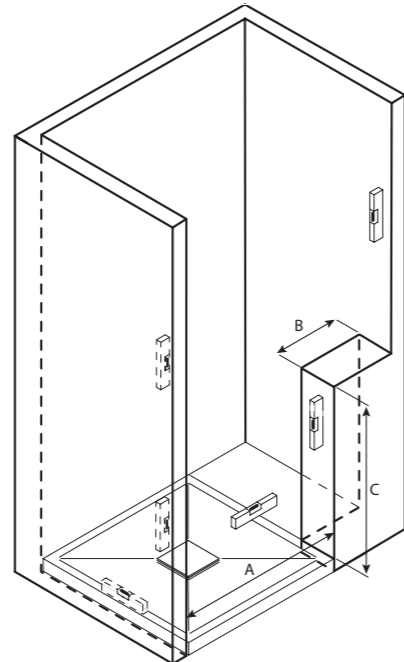

A ..... cm  
B ..... cm  
C ..... cm

12.

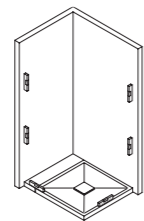
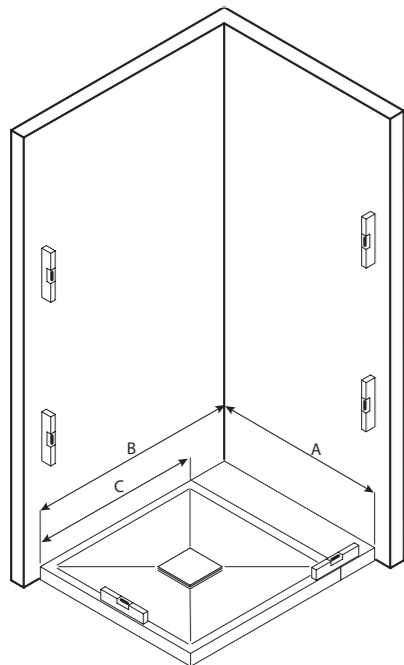

A ..... cm  
B ..... cm  
C ..... cm

13.

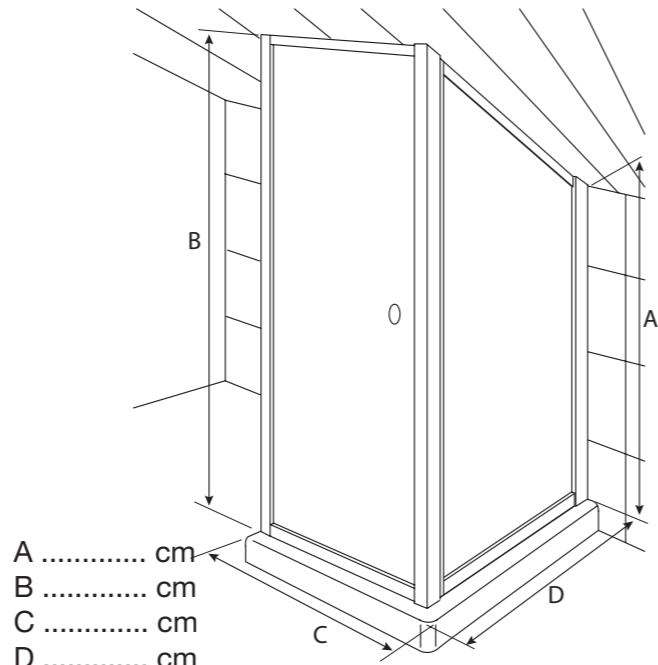

A ..... cm  
B ..... cm  
C ..... cm  
D ..... cm

Esempi di rilievo misure per installazione particolari  
Examples of measurements for special installations

14.

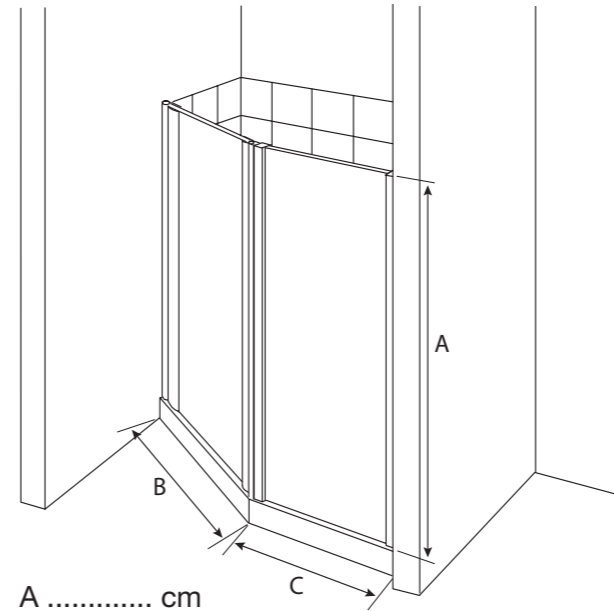

A ..... cm  
B ..... cm  
C ..... cm

15.

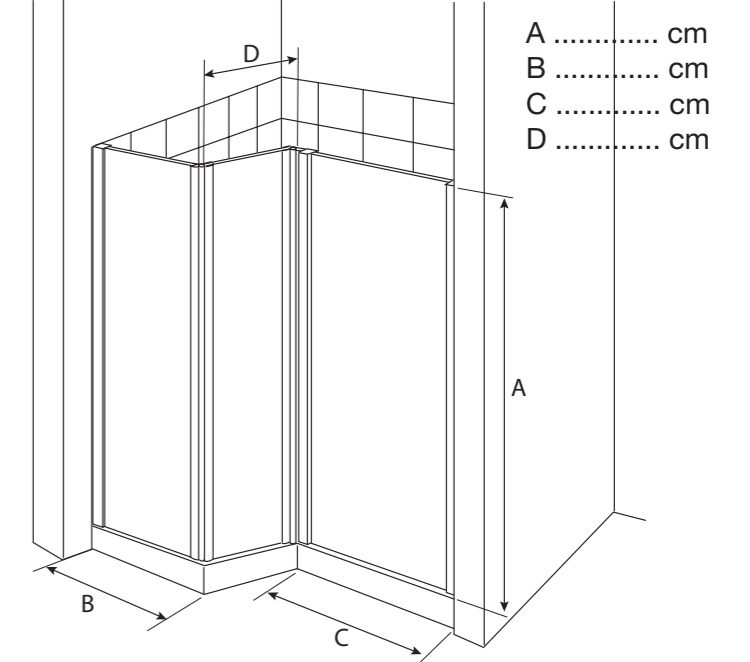

A ..... cm  
B ..... cm  
C ..... cm  
D ..... cm

16.

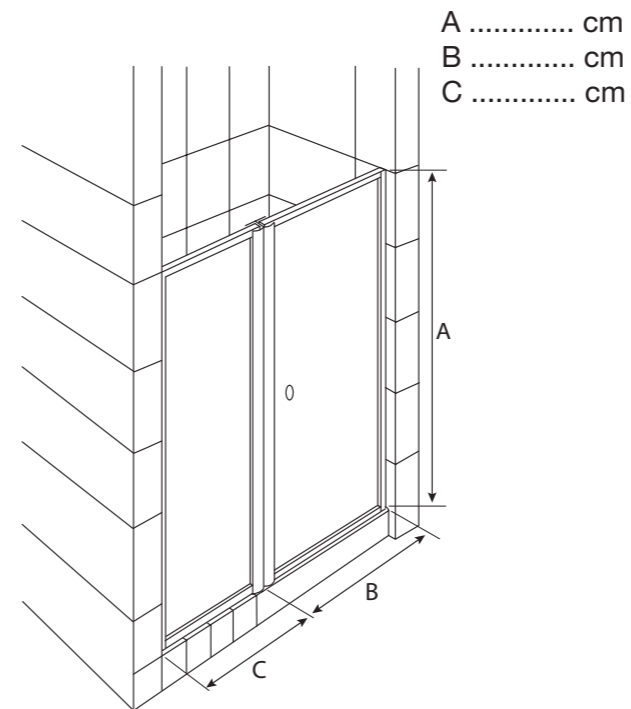

A ..... cm  
B ..... cm  
C ..... cm

17.

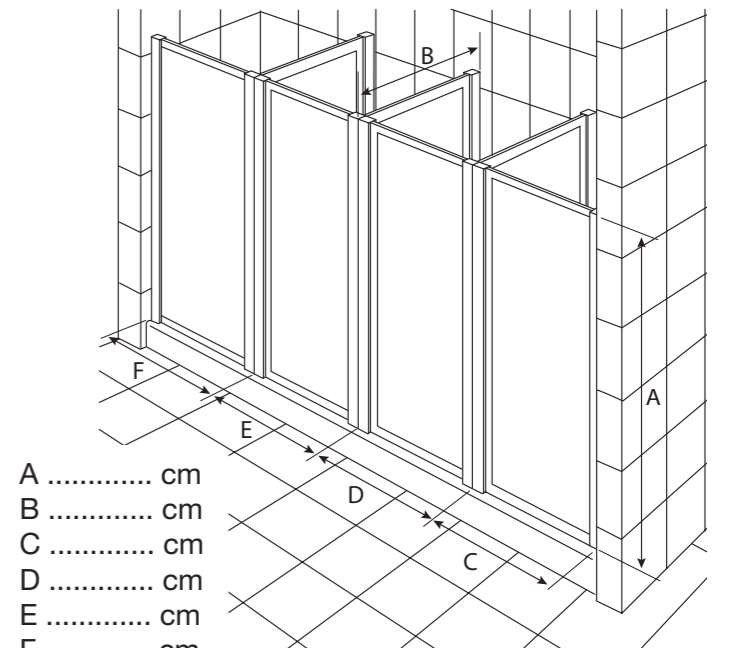

A ..... cm  
B ..... cm  
C ..... cm  
D ..... cm  
E ..... cm  
F ..... cm

Esempi di rilievo misure per installazione particolari  
Examples of measurements for special installations

18.

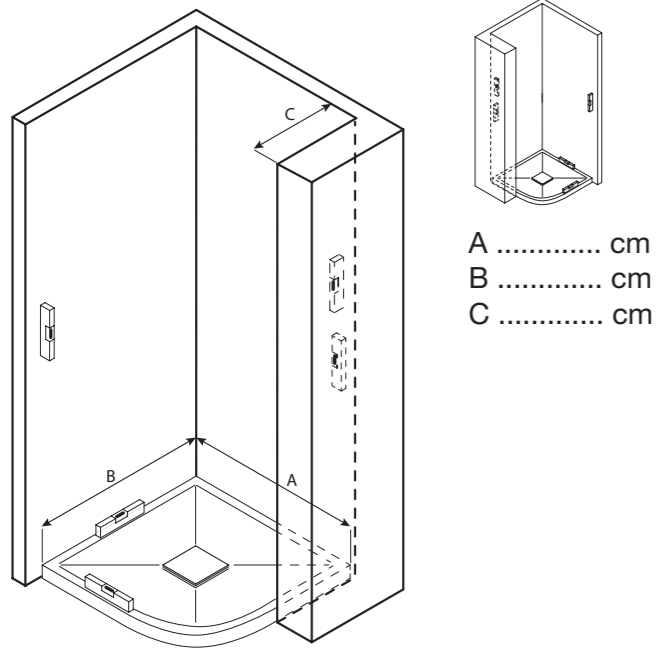

19.

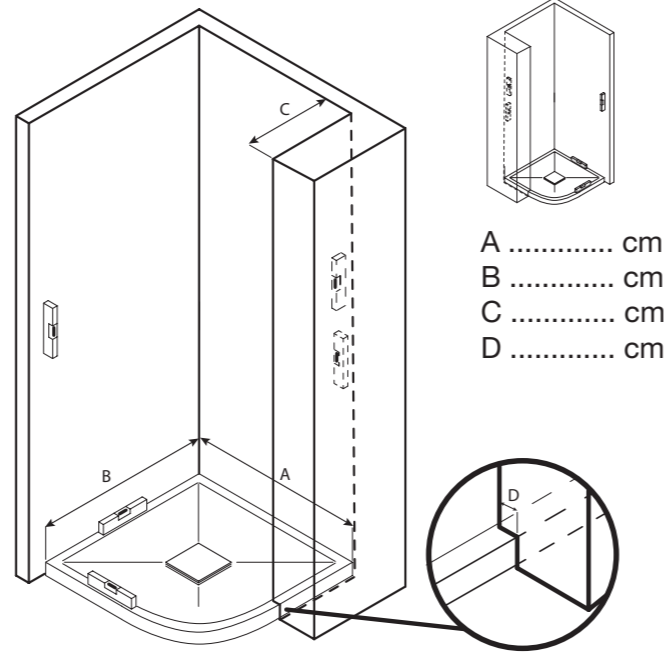

20.

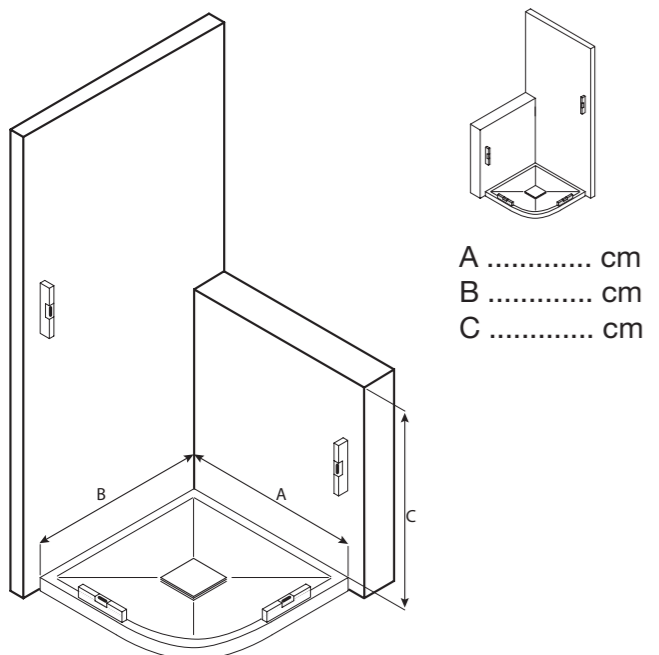

21.

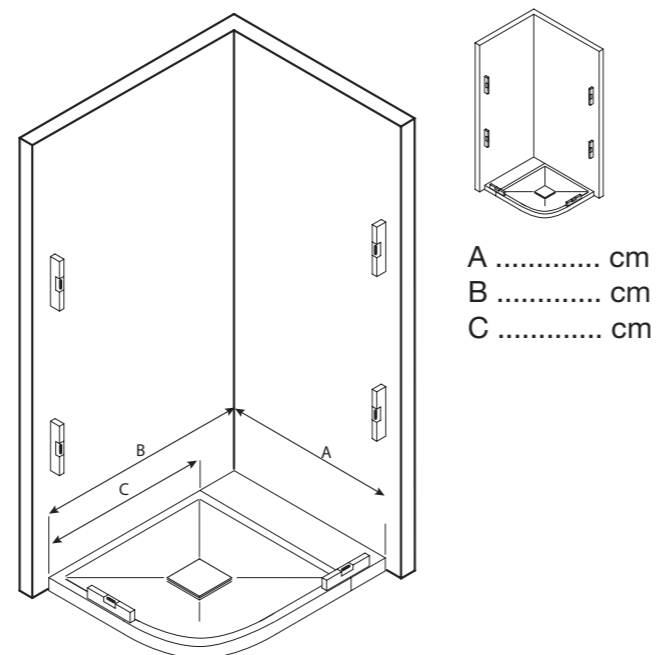

Esempi di rilievo misure per installazione particolari  
Examples of measurements for special installations

22.

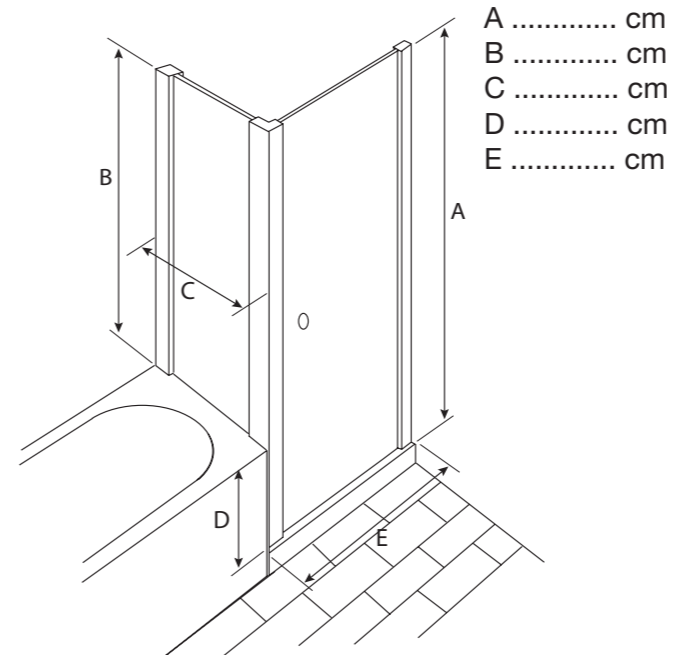

23.

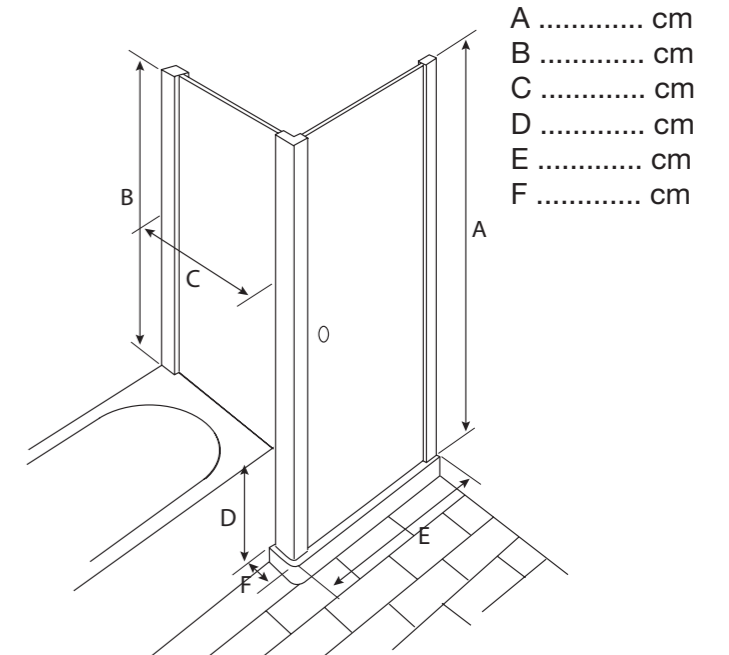

24.

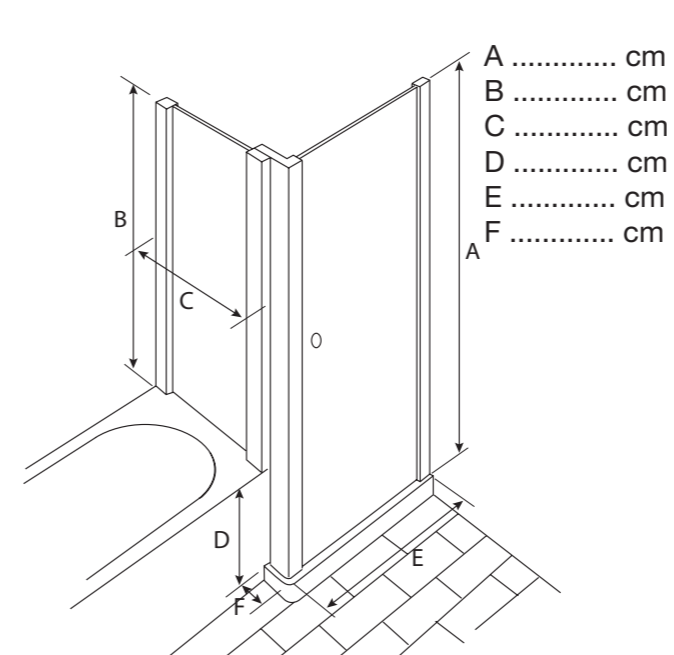

**IT** TDA Srl garantisce i propri prodotti per 24 mesi a partire dalla data di acquisto secondo le normative Europee vigenti in materia. La garanzia TDA copre esclusivamente i difetti di fabbricazione o di assemblaggio. Eventuali difetti estetici o strutturali della cabina doccia vanno segnalati per iscritto, a mezzo email o fax, corredati dal documento d'acquisto e da immagini fotografiche che attestino chiaramente il difetto, prima di procedere con il montaggio della parete doccia, al proprio rivenditore o al servizio post-vendita di TDA. Qualsiasi difetto segnalato ad avvenuto montaggio non potrà essere in alcun modo risarcito. TDA si impegna ad intervenire tempestivamente nel garantire la riparazione o sostituzione degli elementi riconosciuti difettosi. Non sono assolutamente contemplate eventuali richieste di indennizzo da parte dell'acquirente derivate da disagi, costi aggiuntivi, ecc. Il personale tecnico di TDA interverrà per riscontrare e riconoscere l'eventuale difetto per poi procedere alla sua risoluzione.

Sono esclusi dalla garanzia TDA:

- danni arrecati ed imputabili al trasporto non comunicati al trasportatore;
- rotture dei vetri causate dalla movimentazione manuale o da impatti accidentali durante l'utilizzo;
- danni arrecati da installazioni non effettuate "a regola d'arte" secondo le istruzioni di montaggio di TDA;
- danni arrecati da interventi sulla parete doccia effettuati da personale non competente e non autorizzato;
- difetti dovuti alla normale usura del prodotto o all'incuranza da parte del fruitore;
- difetti o malfunzionamenti riconducibili all'uso di prodotti per la pulizia non idonei da parte del fruitore;
- malfunzionamenti riconducibili a cause di forza maggiore;
- manomissioni da parte dell'acquirente riscontrate dal servizio tecnico.

TDA Srl declina ogni responsabilità per danni a persone, animali e/o cose causati da scorrette installazioni o egolazioni, dallo scorretto utilizzo o da mancate manutenzioni periodiche e dalla mancata scrupolosa osservanza di tutta la documentazione allegata al prodotto.

Qualora vengano richiesti interventi di manutenzione, di qualsiasi tipologia essi siano, oltre i tempi coperti dalla garanzia o che non rispettino i punti sopra elencati, verranno applicate le tariffe da listino convenzionale.

TDA Srl garantisce la disponibilità dei pezzi di ricambio di un prodotto fino a 2 anni dall'uscita di produzione e successivamente fino ad esaurimento delle scorte.

## SERVIZI PRE- E POST- VENDITA ITALIA

TDA Srl dispone di una rete di CAT (Centri Assistenza Tecnica) affiliati in tutta Italia. I servizi erogati di installazione, assistenza tecnica e manutenzione sono a pagamento secondo il tariffario del CAT affiliato. Il personale impiegato dai CAT è specializzato e costantemente formato per garantire piena soddisfazione sia per l'assistenza che per l'installazione delle pareti doccia TDA; per conoscere il CAT più vicino consultare il sito [www.tda.it](http://www.tda.it) nell'apposita sezione.

Per richiedere l'intervento dell'assistenza tecnica direttamente a TDA, inviare una email ad [css@tda.it](mailto:css@tda.it) indicando le generalità dell'installatore, quelle dell'utente ed eventuali fotografie.

**EN** Warranty is valid 24 months after purchase according to the European regulations. TDA warranty includes manufacturing and assembling faults ONLY.

Aesthetic or functional faults have to be reported in writing, together with the invoice and pictures BEFORE installation. Any claim after installation will not be considered.

TDA will take prompt actions to check the damage and solve the problem. TDA technical team will check and confirm (or not) the above fault and will take actions accordingly.

The warranty does not include:

- damages occurred during transport which have not been reported to the carrier;
- glass crash due to lack of attention in handling or during installation;
- wrong installation in spite of written instructions;
- wrong actions made by unqualified people;
- wrong actions taken by consumers and detected and confirmed by TDA technical service normal wear and tear.

TDA is not responsible for damages occurred to people, animals and/or things which are caused by faulty installation or wrong maintenance.

Should technical assistance be needed after warranty expires, the costs (price list) will be charged to consumer.

Spare parts are available also in case a product is dismissed, up to 2 years after discontinuance.

## IT

## Listino Prezzi 26 IE / €

|     |   |     |   |
|-----|---|-----|---|
| 1.1 | 1. VALIDITA' E DIRITTO DI MODIFICA<br>Qualsiasi contratto sottoscritto da TDA Srl per la vendita dei propri prodotti indicati nel listino prezzi (di seguito i "Prodotti" e ciascuno di essi il "Prodotto") a qualunque cliente (di seguito l'"Acquirente") sarà soggetto alle presenti condizioni generali di vendita.<br>In caso di discordanza tra quanto previsto dalle presenti condizioni generali di vendita e quanto pattuito in specifici accordi tra TDA Srl e l'Acquirente, prevarrà quanto previsto in detti specifici accordi.                                       | 4.5 | TDA Srl si riserva il diritto di valutare la fattibilità di Prodotti su specifica richiesta dell'Acquirente, di stabilirne i prezzi, le modalità e i termini di consegna.   |
| 1.2 | TDA Srl si riserva il diritto di modificare e/o variare le presenti condizioni generali di vendita nonchè il listino prezzi.  | 4.6 | Non si accettano annullamenti d'ordine per Prodotti dedicati o realizzati su specifica richiesta dell'Acquirente.   |
| 2.1 | <b>2. CARATTERISTICHE DEI PRODOTTI</b><br>Nei singoli contratti di vendita stipulati da Tda Srl, le eventuali informazioni riguardanti i Prodotti ed il loro uso sono vincolanti per le parti, salvo che le parti non abbiano previsto diversamente nel singolo contratto di vendita.   | 5.1 | <b>5. GARANZIA DI CONFORMITA' PRODOTTI</b><br>TDA Srl garantisce i propri prodotti per 24 mesi a decorrere dalla data d'acquisto. La garanzia copre esclusivamente vizi e difetti di fabbricazione o assemblaggio.<br>Difetti estetici o strutturali devono essere comunicati per iscritto a TDA Srl solo ed esclusivamente prima dell'installazione, allegando i documenti di acquisto e di prodotto.  |
| 2.2 | Eventuali informazioni o dati sulle caratteristiche e/o specifiche tecniche dei Prodotti contenute nel listino prezzi sono indicative e non vincolanti. I Prodotti vengono realizzati con diversi materiali: TDA Srl si riserva il diritto di apportare ai Prodotti le modifiche che, senza alterarne le caratteristiche essenziali e di imballo, dovessero risultare necessarie.   | 5.2 | La garanzia impegna TDA Srl solo alla riparazione e/o alla sostituzione degli elementi difettosi: sono pertanto escluse ulteriori pretese da parte dell'Acquirente, ed esclude qualsiasi indennizzo derivato dal disagio, od onere o costo relativo accessorio.   |
| 3.1 | <b>3. PREZZO E TERMINI DI PAGAMENTO</b><br>Ove non vi sia stato uno specifico accordo tra TDA Srl e l'Acquirente in merito al prezzo dei Prodotti, si applicherà per ciascun Prodotto il relativo prezzo di listino in vigore al momento della conclusione del contratto. I prezzi per la vendita dei Prodotti indicati nel listino prezzi si intendono franco Magazzino Centrale o franco fabbrica, IVA e ogni altra tassa o imposta esclusa.  | 5.3 | La non conformità dovrà essere riconosciuta solo da parte di personale autorizzato da TDA Srl.<br>Sono comunque esclusi dalla garanzia i seguenti casi:<br>- Se il difetto è riconducibile al trasporto.<br>- Rotture di tutte le parti in vetro temperato, in particolare causate da impatto, urti durante il trasporto, movimentazione manuale degli elementi in fase di installazione e impatti accidentali durante l'utilizzo.<br>- Se l'installazione non è stata eseguita dettagliatamente secondo istruzioni TDA Srl<br>- Se il vizio di funzionamento è conseguente ad un intervento sul prodotto non autorizzato.<br>- Se il funzionamento difettoso è conseguente alla normale usura del prodotto, alla negligenza o incuranza da parte dell'Acquirente nel rispetto delle indicazioni allegato al prodotto.<br>- Se il difetto è riconducibile all'utilizzo di detergenti abrasivi, a base acida, o prodotti non adatti alla pulizia di superfici laccate, verniciate, anodizzate e vetrose. Si consiglia l'utilizzo di articoli per la cura del Prodotto a marchio TDA Srl.<br>- Se il funzionamento difettoso è conseguente a forze maggiori.<br>- Manomissione del prodotto da parte dell'Acquirente. |
| 3.2 | Qualora l'Acquirente non effettui il pagamento di quanto dovuto entro il termine pattuito, TDA Srl potrà, a propria discrezione e senza alcun preavviso, sospendere le consegne in corso relativamente ai Prodotti non ancora consegnati e/o annullare le ulteriori consegne.<br>A pagamento avvenuto, i tempi di spedizione degli ordini rimasti in sospeso saranno ricalcolati, a far data dal pagamento stesso, in base ai termini di produzione indicati nel listino prezzi.<br>I pagamenti dei Prodotti già consegnati non saranno subordinati al completamento dell'ordine. | 5.4 | TDA Srl declina qualsiasi responsabilità per eventuali danni e persone, animali o cose causati da errori di installazione, di regolazione, imperfetto utilizzo o la mancata osservanza di tutte le prescrizioni indicate nella documentazione allegata al prodotto.   |
| 3.3 | Senza alcun pregiudizio per gli ulteriori rimedi consentiti dalla legge e dalle presenti condizioni generali di vendita, fatto salvo il diritto al risarcimento dei danni, TDA Srl si riserva il diritto di applicare tassi di mora su pagamenti ritardati a decorrere dalla data in cui sia maturato il diritto di pagamento, in attuazione dal Decreto Legislativo n°231/2002 e secondo gli aggiornamenti comunicati periodicamente dal Ministero dell'Economia e delle Finanze, senza necessità di formale costituzione in mora.   | 5.5 | TDA Srl si riserva il diritto di apportare modifiche tecniche ed estetiche ai propri prodotti in qualsiasi momento senza preavviso, ivi comprese modifiche a volume e peso.   |
| 3.4 | TDA Srl ha diritto al risarcimento dei costi sostenuti per l'eventuale recupero delle somme non tempestivamente corrispostegli, come previsto dal Decreto Legislativo n°231 del 2002.   | 6.1 | <b>6. RESA E SPEDIZIONE PRODOTTI</b><br>Il destinatario è obbligato a controllare la merce in arrivo e a contestare subito gli eventuali danni direttamente al trasportatore che ne è responsabile. E' diritto del destinatario e dovere del trasportatore controllare la spedizione (senza aprire l'imballo) e apporre le eventuali riserve specifiche sul DDT dal trasportatore e quello TDA Srl.<br>La sola dicitura generica: "RISERVA DI CONTROLLO" non è valida.  |
| 3.5 | Il prezzo pattuito, salvo ove diversamente indicato, rimane invariato fino alla data di spedizione indicata nella conferma d'ordine. Se, per richiesta dell'Acquirente o per motivi non imputabili a TDA Srl, la data di spedizione viene posticipata, TDA Srl si riserva di rivedere il prezzo applicando all'Acquirente eventuali aumenti e/o spese di sosta e magazzinaggio nel frattempo intervenuti.   | 6.2 | Danno occulto: nel caso di colli rovinati, solo esternamente, questi possono essere ritirati indicando sui DDT (documento di trasporto) del trasportatore e di TDA Srl la clausola "RISERVA DI CONTROLLO", specificando la motivazione per cui si è posta la riserva, come previsto dalla normativa vigente in materia di trasporto. Nel caso di rotture accertate, il destinatario deve darne comunicazione scritta a mezzo raccomandata a TDA Srl e per conoscenza al trasportatore spedendola entro e non oltre 8 giorni dal ricevimento merce.  |
| 3.6 | I pagamenti devono essere effettuati esclusivamente a favore di TDA Srl Via Circonvallazione, 1 San Gervasio B.no. Qualora l'Acquirente utilizzi per le rimesse di denaro: assegni, cambiali, ricevute od altri strumenti bancari, tali pagamenti, ovunque fatti, si intendono effettuati presso la Venditrice e saranno imputati secondo le regole dell'art.1194 del Codice Civile. Ogni altro pagamento dovrà essere fatto esclusivamente ad incarichi della Venditrice muniti di mandato ad incassare e rilasciare quietanza.  | 6.3 | Danno accertabile: nel caso di danno evidente ed accertabile anche dal trasportatore, deve essere posta una riserva sul DDT del trasportatore e di TDA Srl indicando chiaramente quantità e codici danneggiati ed il tipo di danno esterno ed interno riscontrato. Copia dei DDT devono essere inviati all'ufficio clienti TDA Srl che successivamente darà le opportune disposizioni per l'eventuale sostituzione e reso del materiale. Da quanto previsto ai paragrafi 6.2 e 6.3. TDA Srl non riconoscerà alcun rimborso per danni o rotture riscontrate.   |
| 4.1 | <b>4. ACCETTAZIONE DEGLI ORDINI</b><br>Gli ordini verranno considerati validi solo se effettuati per iscritto e ricevuti da TDA Srl via e-mail agli indirizzi dalla stessa comunicati.  | 6.4 | Nessun articolo può essere reso senza l'autorizzazione scritta da TDA Srl: i resi autorizzati dovranno pervenire in porto franco al ns. stabilimento utilizzando il trasportatore ed il numero di riferimento comunicati da TDA Srl. Il numero di riferimento deve essere riportato sul documento di trasporto.   |
| 4.2 | Nessun contratto sarà concluso tra TDA Srl e l'Acquirente fino a che non vi sia stata accettazione scritta dell'ordine dell'Acquirente da parte di TDA Srl, tramite piano di evasione giunto a conoscenza dell'Acquirente.  | 6.5 | Nessun articolo può essere reso senza l'autorizzazione scritta da TDA Srl: i resi autorizzati dovranno pervenire in porto franco al ns. stabilimento utilizzando il trasportatore ed il numero di riferimento comunicati da TDA Srl. Il numero di riferimento deve essere riportato sul documento di trasporto.<br>Se nell'accurato controllo TDA Srl si riscontrassero incurie dell'Acquirente, il materiale reso sarà gravato di un importo per la copertura delle spese generali oltre ad eventuali spese di ripristino a nuovo.   |
| 4.3 | Ordine e/o modifiche di ordini dovranno essere comunicati/confermati per iscritto dall'Acquirente tramite e-mail.   |     |   |
| 4.4 | Ordini di importo netto inferiore ad Euro 250,00 (IVA esclusa) saranno gravati di un addebito di Euro 10,00 netti per spese forfetarie di gestione ordine.  |     |   |

|      |   |      |   |
|------|---|------|---|
| 7.1  | <b>7. TERMINI DI SPEDIZIONE DEI PRODOTTI</b><br>La data di spedizione dei Prodotti indicata sul piano di evasione è sempre indicativa e non vincolante, salvo diversamente pattuito per iscritto.   | 12.4 | Ogni diverso utilizzo della proprietà intellettuale di TDA Srl da parte dell'Acquirente, se non espressamente concesso per iscritto da TDA Srl, si intenderà violazione da parte dell'Acquirente dei predetti diritti esclusivi di TDA Srl, anche sotto il profilo della responsabilità contrattuale e, come tale, sarà propriamente perseguito.  |
| 7.2  | Qualora TDA Srl preveda di non essere in grado di spedire i Prodotti nella data di spedizione indicata sul piano di evasione, ne darà avviso all'Acquirente indicando, ove possibile, la nuova data di spedizione prevista. Ove il ritardo imputabile a TDA Srl superi le 6 settimane, l'Acquirente potrà risolvere il contratto reletivamente ai Prodotti di cui la spedizione è ritardata, con un preavviso di 10 giorni, da comunicarsi per iscritto via PEC a TDA Srl, con esclusione di qualsiasi altro rimedio o danno. | 12.5 | I cataloghi, i campioni e i listini dei Prodotti (ad eccezione di quelli meramente illustrativi/pubblicitari) messi a disposizione dell'Acquirente da TDA Srl, non devono essere consegnati, né mostrati a terzi, né riprodotti, senza previa autorizzazione scritta di TDA Srl.<br>I Materiali devono essere restituiti a semplice richiesta di TDA Srl.<br>La conformità del Prodotto al campione fornito all'Acquirente, sia nella prima che nelle successive forniture, può presentare delle difformità rispetto al Prodotto venduto dovute sia alla variazione tecnica del Prodotto, sia alla consistenza fisica del Campione (es: colori, materiali, misure, ecc.), causate anche da fattori ambientali (es: umidità, esposizione alla luce, ecc.).   |
| 7.3  | Non si considera imputabile a TDA Srl l'eventuale ritardo dovuto a cause di forza maggiore o caso fortuito, atti, omissioni dell'Acquirente (ad esempio mancata comunicazione di indicazioni necessarie per la fornitura dei Prodotti).   | 13.1 | <b>13. INFORMATIVA</b><br>Il Regolamento (UE) 679/2016 stabilisce che il soggetto interessato debba essere preventivamente informato in merito all'utilizzo dei dati che lo riguardano e che il trattamento di dati personali è ammesso solo con il consenso espresso del soggetto interessato, salvo i casi previsti dalla legge.<br>Titolare del trattamento.<br>Il Titolare del trattamento dei dati è TDA S.r.l. - via Circonvallazione, 1 - 25020 - San Gervasio Bresciano (BS) - Italia.<br>Tel. 030 9926311 - mail info@tda.it   |
| 7.4  | Nel caso in cui, per cause non imputabili a TDA Srl, TDA Srl stessa risultasse temporaneamente o permanentemente impossibilitata ad effettuare la spedizione, TDA Srl ne darà informazione all'Acquirente e sarà sollevata dagli obblighi di spedizione per tutta la durata dell'impedimento e per tutto il tempo in cui si protraggono gli effetti ad esso conseguenti, nonchè da ogni obbligo di risarcimento danni per ritardo o inadempimento nei confronti dell'Acquirente.  | 13.2 | Finalità del trattamento.<br>I dati personali sono trattati nell'ambito della normale attività dell'azienda TDA S.r.l. per finalità relative a:<br>. Adempimento di obblighi fiscali o contabili;<br>. Gestione della clientela (amministrazione della clientela, amministrazione di contratti, ordini e fatture, gestione delle prenotazioni);<br>. Gestione dei fornitori (amministrazione dei fornitori, amministrazione di contratti, ordini, fatture, selezione in rapporto alle necessità dell'impresa);<br>. Preparazione di preventivi, gestione ed esecuzione di contratti.  |
| 7.5  | In ogni caso, e fatto salvo quanto sopra previsto per il caso di risoluzione del contratto, il risarcimento del danno effettivo subito dall'Acquirente per ritardare spedizioni imputabili a TDA Srl non potrà eccedere un importo massimo corrispondente al 5% del prezzo netto dei Prodotti spediti in ritardo.   | 13.3 | Destinatari o categorie di destinatari ai quali i dati personali possono essere comunicati.<br>I dati potranno essere trasmessi a società o persone esterne che svolgono attività strettamente connesse e strumentali alla gestione del rapporto commerciale, quali:<br>. istituti di credito e società di transazioni finanziarie;<br>. consulenti e liberi professionisti, singoli ed associati<br>Periodo di conservazione.<br>I dati personali saranno conservati per una durata massima di 10 anni dall'ultima fatturazione e/o fino alla conclusione del rapporto contrattuale e oltre solo per l'adempimento di obblighi fiscali e contabili.  |
| 7.6  | Sono comunque esclusi da ogni risarcimento i danni indiretti, consequenziali o punitivi.  | 13.4 | Diritti dell'interessato.<br>L'interessato ha diritto di ottenere dal Titolare la conferma che sia o meno in corso un trattamento di dati personali che lo riguardano e in tal caso ha il diritto di:<br>. ottenere l'accesso ai dati personali, chiederne la rettifica, la cancellazione, la limitazione o di opporsi al loro trattamento;<br>. ricevere in un formato strutturato, di uso comune e leggibile da dispositivo automatico i dati personali che lo riguardano e di trasmettere tali dati a un altro Titolare del trattamento (portabilità dei dati);<br>. essere informato dell'esistenza di un processo decisionale automatizzato, compresa la profilazione;<br>. revocare il consenso in qualsiasi momento, senza pregiudicare la liceità del trattamento basato sul consenso prestato prima della revoca;<br>. proporre reclamo all'Autorità di controllo. |
| 8.1  | <b>8. RECLAMI</b><br>E' inteso che eventuali reclami o contestazioni, riguardanti una parte dei Prodotti consegnati o una singola spedizione di Prodotti, non danno diritto all'Acquirente di sospendere o comunque ritardare i pagamenti dei Prodotti oggetto di contestazione, nè, tanto meno, di altre forniture.  | 13.5 |   |
| 9.1  | <b>9. FORO COMPETENTE</b><br>I contratti tra TDA Srl e l'Acquirente sono retti dalla legge italiana, con espressa esclusione di quanto previsto dalla Convenzione di Vienna del 1980 sulla vendita internazionale di merci.   | 13.6 |   |
| 9.2  | Per qualsiasi controversia tra le parti, relativa ai rapporti di compravendita o fornitura, alla loro instaurazione, esecuzione o cessazione, sarà esclusivamente competente il Foro di Milano - Italia.  |      |   |
| 9.3  | Tuttavia, in deroga a quanto sopra stabilito, TDA Srl ha comunque la facoltà di portare la controversia davanti al giudice competente presso la sede dell'Acquirente.   |      |   |
| 10.1 | <b>10. ECO CONTRIBUTO RAEE</b><br>I prezzi si intendono comprensivi da eco contributo RAEE.   |      |   |
| 11.1 | <b>11. FORZA MAGGIORE</b><br>Ciascuna parte potrà sospendere l'esecuzione dei propri obblighi contrattuali quando tale esecuzione sia resa impossibile o irragionevolmente onerosa da un impedimento imprevedibile indipendente dalla sua volontà, quale ad esempio sciopero, boicottaggio, serrata, incendio, guerra (dichiarata o non) guerra civile, sommosse e rivoluzioni, requisizioni, embargo, interruzioni di energia, ritardi nella consegna di componenti o materia prima.   |      |   |
| 11.2 | La parte che desidera avvalersi della presente clausola dovrà comunicare immediatamente per iscritto all'altra parte il verificarsi e la cessazione delle circostanze di forza maggiore.  |      |   |
| 11.3 | Qualora la sospensione dovuta a forza maggiore duri più di 6 settimane, ciascuna parte avrà il diritto di risolvere il presente contratto, previo un preavviso di 10 giorni, da comunicarsi alla controparte per iscritto.  |      |   |
| 12.1 | <b>12. PROPRIETA' INDUSTRIALE E INTELLETTUALE</b><br>L'Acquirente riconosce che i documenti, disegni, marchi, nomi, dati ed informazioni, (sia in forma cartacea, sia su supporto elettronico) relativi ai Prodotti sono di esclusiva proprietà di TDA Srl e non possono essere divulgati, alterati, modificati, rimossi o cancellati in qualsiasi modo.  |      |   |
| 12.2 | L'Acquirente si impegna a non riprodurli/divulgarli a terzi ed a limitarne l'uso allo specifico Prodotto acquistato.  |      |   |
| 12.3 | L'Acquirente ha il limitato diritto di uso dei marchi, nomi o altri segni distintivi così come di ogni altro diritto di privativa industriale o know-how produttivo e commerciale incorporato nei Prodotti e che rimane di proprietà esclusiva di TDA Srl, al solo e limitato fine di utilizzare o di rivendere i Prodotti al pubblico.   |      |   |

EN

## Price List 26 EN / €

Prices VAT excluded  
Sizes in cm

|                                    |   |  |   |   |
|------------------------------------|---|--|---|---|
| 1. VALIDITY AND MODIFICATION RIGHT |   | - if defect is due to the use of abrasive detergents or cleaning products not suitable for glass, anodized, laquered or varnished surfaces;<br>- if defective functioning is due to "force majeure" reasons;<br>- purchaser manumission of the product.  | 9. JURISDICTION   | 13. NOTICE  |
| 1.1                                | Any agreement subscribed by TDA srl for the sale of the products mentioned on the price list (hereinafter the "Products" and each of them the "Product" ) to any consumer (hereinafter referred to as "Buyer") will be subject to the present general sales conditions.   | 5.4 TDA Srl declines any responsibility for possible damages caused by bad installation or adjustments errors, incorrect use or no observance of all prescriptions indicated in product enclosed documents.  | 9.1 Agreements between TDA Srl and the Buyer are ruled by Italian law, with the exclusion of what required by the Wien Convention of 1980 on the international sale of goods.   | 13.1 Definition<br>The (EU) Regulation 679/2016 establishes that the interested party must be informed in advance about the use of data concerning him and that the processing of personal data shall be authorised only with the express consent of the subject concerned, except in circumstances provided for by law.  |
| 1.2                                | TDA srl can amend the present general sales conditions as well as the price list without notice.  | 5.5 TDA srl reserves the full right to technically and aesthetically modify the Product at anytime and without previous notice, including changes in volume and weight.  | 9.2 For any dispute between the parties relating to sale or supply relations, to their establishment, performance or termination, shall have as exclusive jurisdiction the Court of Milan – Italy.  |   |
| 2. PRODUCTS' FEATURES              |   | 6. SHIPMENT AND PRODUCTS RETURN  | 9.3 However, notwithstanding the provision above, TDA srl still has the power to bring the dispute before the competent court at the site of the Buyer.   | 13.2 Data controller<br>The Data controller is TDA S.r.l. - via Circonvallazione, 1 – 25020, San Gervasio Bresciano (BS) – Italia.<br>Tel. 030 9926311 - mail info@tda.it   |
| 2.1                                | In each sales agreement between TDA srl and the Buyer, all information concerning the Products shall be binding for both parties, except for specific written amendments.   | 6.1 Deliveries must be immediately inspected, in case of wrong items, and/or shortages, and/or any defect, have to be reported to the forwarder which is the only responsible for it. It is in the right of the receiver and the duty of the forwarder to control the delivery (without opening the package). A formal making specific notification on the delivery notes, the generic written sentence is not sufficient. | 10. WEEE CONTRIBUTION   |   |
| 2.2                                | Any technical information concerning the Products are indicative and not binding. The Products are made of different materials: TDA srl can make necessary improvements to the Products, keeping the basic characteristics and packaging unchanged.   | 6.2 Hidden damage: if on delivery, the goods show obvious packaging defects, they can be withdrawn, but the receiver is obliged to note the defects on the PoD marking them with "subject to inspection" and specifying the reasons, as stated in the current EU regulations. The claim for damages has to be sent to TDA Srl in writing within 7 days from delivery.  | 10.1 The Prices do not include the WEEE contribution.   | 13.3 Purposes of the processing<br>Personal data are processed as part of the normal activity of the company TDA S.r.l. for purposes relating to:<br>. Fulfillment of tax or accounting obligations;<br>. Customer management (customer administration, contract administration, orders and invoices, reservation management);<br>. Supplier management (supplier administration, contract administration, orders, invoices, selection in relation to the company's needs);<br>. Preparation of cost estimations, management and execution of contracts.  |
| 3. PRICE AND PAYMENT TERMS         |   | 6.3 Verified damage: in case of evident damage verified by the receiver and the forwarder, the damage evidence must be duly marked on PoD, indicating very clearly the quantity and the damaged product codes, checking if the damage is on the internal or external side. A further copy of PoD must be sent to TDA srl customer service that will arrange the possible replacement upon reception of the damaged goods.  | 11. FORCE MAJEURE   |   |
| 3.1                                | The current pricelist will be applied at the moment of signature of the Sales agreement. Prices are intended to be ex-works.  | 6.4 Unlike what is clearly specified on the paragraphs 6.2 and 6.3, TDA srl will not recognize any refund for the damage or breakage.  | 11.1 Either party may suspend performance of its contractual obligations when such performance is made impossible or unreasonably onerous by an unforeseeable obstacle beyond its control, such as strike, boycotting, lockouts, fire, war (declared or not), power interruptions, delays in delivery of components or materials.   |   |
| 3.2                                | In case of unsolved payment, TDA srl will stop deliveries of outstanding orders. The delivery time of the pending order will be recalculated, starting from the payment date according to standard timings expressed in this document. Payments for Products already delivered will not be subject to completion of the order.  | 6.5 No item can be returned without TDA Srl written permission. Authorized returns must be sent to our warehouse without charging transport costs, using TDA srl courier indicating the reference number.  | 11.2 The party wishing to make use of this clause must notify immediately in writing to the other part the occurrence and cessation of the circumstances of force majeure.  | 13.4 Addresses and addresses' categories to whom personal data can be communicated.<br>The data can be transmitted to a company or external persons who carry out instrumental activities strictly connected with the management of the commercial relationship, such as:<br>. financial institutions and financial transaction companies;<br>. advisors and legal professionals, individual or associated.   |
| 3.3                                | TDA srl has the right to calculate accruals on pending payments according to EU Directives.   | 7. DELIVERY TERMS  | 11.3 If the suspension due to force majeure lasts more than 6 weeks, each party shall be entitled to terminate this contract, with 10 days prior notice, to be notified to the other party in writing.  |   |
| 3.4                                | The agreed price, is valid until the delivery date as per order confirmation. If the delivery date is postponed, upon request of the Buyer or for reasons not depending on TDA srl, TDA srl can charge additional storage costs to the Buyer.   | 7.1 The delivery date as per order confirmation is not binding unless differently agreed by the Parties in writing.  | 12. INDUSTRIAL AND INTELLECTUAL PROPERTY  |   |
| 4. ORDER ACCEPTANCE                |   | 7.2 Where TDA srl is not in the condition to ship punctually, TDA Srl shall give notice to the Buyer, adding, if possible the new delivery date. If TDA Srl delay exceeds 6 weeks, the Buyer can terminate the commercial agreement, with 10 days written notice.  | 12.1 The Buyer acknowledges that the documents, drawings, logos, names, data and information (both in paper form, either in electronic form) are exclusive property of TDA srl and cannot be disclosed, altered, modified, removed or erased in any way.  | 13.5 Retention period<br>Personal data will be stored for a maximum duration of 10 years from the last invoicing and/or until the conclusion of the contractual relationship and beyond only for the fulfillment of fiscal and accounting obligations.  |
| 4.1                                | Orders will be considered valid only if made in writing.  | 7.3 Any delay due to "force majeure" or unforeseen events or incorrect delivery information from the Buyer is not considered TDA srl responsibility.   | 12.2 The Buyer agrees not to reproduce/disclose to third parties and to restrict their use to the specific Product purchased.   |   |
| 4.2                                | Any Sales Agreement between TDA srl and the Buyer will be accepted by TDA srl only in writing.  | 7.4 In case, for reasons independent from TDA Srl, shipment were not possible, TDA Srl will inform the Buyer and will decline any responsibility for the delay.  | 12.3 The Buyer shall have the limited right to use trademarks, names or other distinguishing marks as well as any other industrial executive right or manufacturing and commercial know-how associated with the goods, which remains exclusive property of TDA Srl, to the sole and limited purpose to utilize or resell the goods to the public. Any other use of the TDA Srl intellectual property by the Buyer, unless expressly, granted in writing by TDA Srl, will be considered an infringement of the TDA Srl exclusive rights by the Buyer, also in terms of contractual liability and, as such, will be prosecuted. | 13.6 Rights of the data subject<br>The data subject has the right to obtain from the Data Controller confirmation that he is or is not undergoing treatment of personal data concerning him; in this case he has the right to:<br>obtain access to personal data, request rectification, cancellation, limitation or oppose their processing;<br>receive, in a structured, machine-readable and commonly used format, personal data concerning him and to transmit such data to another Data Controller (data portability);<br>be informed of the existence of an automated decision-making process, including profiling;<br>revoke the consent at any time, without prejudice to the lawfulness of the treatment based on the consent given prior to the revocation;<br>submit a complaint to the Supervisory Authority. |
| 4.3                                | Order and/or amendments to orders shall be confirmed by the buyer in writing.   | 7.5 In any case, and except in case of contract termination, the compensation for loss occurred for delays in deliveries due to TDA srl responsibility will not exceed a maximum the amount equal to 5% of the net value of the above order.   | 12.4 All catalogues, as well as samples and products' price lists (excluding those for illustrative and advertising purposes only) made available to the Purchaser by the TDA Srl, must not be handed out, shown to third parties, or reproduced without the TDA Srl prior written authorisation. All materials must, on mere request, be returned to the TDA Srl.  |   |
| 4.4                                | For orders value less than € 250,00 (VAT excluded) TDA will charge additional € 10,00 (excluding VAT) for transport costs.  | 7.6 The payment of the above amount will not be followed by any other reimbursement.   | 12.5 The conformity of the product with the samples supplied to the Purchaser both in the first and in the next supplies may differ from the product sold on the base of technical modifications as well as to the physical substance of the sample (e.g. colours, materials, dimensions, etc.) and caused by environmental factors (e.g. damp, exposure to sunlight etc.).   | 13.7 Nature of data and consequence of the failure to notify Without the processing and communication of data of a compulsory nature for the described purposes, the requested services and/or products, in whole or in part, cannot be provided to the interested party.   |
| 4.5                                | TDA srl will decide upon feasibility of Customized Products and will fix prices and delivery terms.   | 8. COMPLAINTS  |   |   |
| 4.6                                | Cancellation of special products orders will not be accepted.   | 8.1 It is agreed that any complaints or disputes concerning any part of the delivered Products or a single shipment of Products, do not entitle the Buyer to suspend or delay the payment of the order or of new orders.   |   |   |
| 5. PRODUCT COMPLIANCE              |   |  |   |   |
| 5.1                                | TDA srl warranty is 24 months valid according to the Eu Directives. It covers manufacturing and components faults only. Claims must be forwarded to TDA srl in writing and before installation, adding purchasing documents, pictures etc.  |  |   |   |
| 5.2                                | TDA Srl warranty will cover the replacement of faulty elements. TDA srl technical team will check the claimed damage before giving authorization.   |  |   |   |
| 5.3                                | TDA srl warranty will not cover the following:<br>- if defect has reference to transport;<br>- tempered glass parts crashes installation is not performed properly according to TDA srl instructions;<br>- if functioning defect is due to unauthorised technical intervention on product;<br>- if defective functioning is due to normal usury, or to the purchaser negligence or carelessness following product indication; |  |   |   |

**TDA srl**

Via Circonvallazione, 1  
25020 San Gervasio Bresciano (BS) - Italy  
Tel. +39 030 9926311  
[www.tda.it](http://www.tda.it)  
[info@tda.it](mailto:info@tda.it)

